



STORZ & BICKEL



Venty

de	GEBRAUCHSANWEISUNG	Seite 2
en	INSTRUCTIONS FOR USE	page 31
fr	MODE D'EMPLOI	page 22
es	MODO DE EMPLEO	página 32
it	ISTRUZIONI PER L'USO	pagina 42
nl	GEbruIKSAANWIJZING	pagina 52

Table of Contents	Page
1 For your Safety	33
1.1 Explanation of Symbols.....	33
1.2 Legend	34
1.3 Important Safeguards.....	34
1.3.1 Basic Rules.....	34
1.3.2 Safety Recommendations.....	35
1.3.2.1 Risk of Injury due to electric Shock.....	35
1.3.2.2 Danger of Injury due to Burning/Vapors.....	35
1.3.2.3 Risk of Injury due to various Causes.....	35
2 VENTY	36
2.1 Scope of Delivery.....	36
2.2 Functional Elements.....	37
2.3 Cooling Unit	38
2.4 Service	38
3 Intended Use	39
4 Overview of Plants	39
5 Factors influencing Vaporization	39
6 Commissioning and Operation	40
6.1 Unpacking	40
6.2 Battery	40
6.2.1 Basic Explanation of the Battery Charge Display.....	40
6.2.2 Charging the Battery	40
6.2.3 End of the Charging Process.....	41
6.3 Filling the Filling Chamber.....	41
6.4 Heating Up	42
6.4.1 Display	42
6.4.2 Default Settings.....	43
6.4.3 Switching on.....	43
6.4.4 Adjusting Temperatures.....	44
6.4.5 Celsius/Fahrenheit	45
6.4.6 Display Backlight.....	45
6.4.7 Bluetooth.....	45
6.4.8 Reset to Default Settings	45
6.5 Application	45
6.6 Adjustable Airflow.....	46
6.7 End of Application.....	46
6.8 Automatic Switching Off	47

Table of Contents	Page
6.9 Storage	47
6.10 STORZ & BICKEL Web App	47
6.10.1 Connecting the Vaporizer with a Smartphone	47
6.10.2 The menu items of the STORZ & BICKEL Web App	47
7 Cleaning/Hygiene	49
7.1 Cooling Unit	49
7.1.1 Disassembling the Cooling Unit	49
7.1.2 Cleaning the Cooling Unit and the Filling Chamber Screen	50
7.1.2.1 Cleaning the Cooling Unit and the Filling Chamber Screen with rinsing Water	51
7.1.2.2 Alternative: Cleaning the Cooling Unit and the Filling Chamber Screen with Isopropyl Alcohol	51
7.1.3 Check the Cooling Unit Parts and the Filling Chamber Screen	52
7.1.4 Assembling the Cooling Unit	52
7.2 Filling Chamber	52
7.2.1 Cleaning the Filling Chamber	52
7.2.2 Removing the Screen	53
7.2.3 Installing the Screen	53
7.3 Cleaning the Vaporizer and the USB-C Cable	53
8 Optional Accessories	54
8.1 List of optional Accessories	54
9 Faults	55
9.1 Possible Faults / Troubleshooting	55
10 Technical Specifications	56
10.1 Vaporizer	56
10.2 Technical Requirements for suitable chargers	56
11 Compliance with legal and normative Requirements	56
11.1 Simplified EU Declaration of Conformity	57
12 Warranty, Liability, Copyright	57
12.1 Warranty	57
12.2 Liability	57
12.3 Copyright	58

1.1 Explanation of Signs



Please follow these instructions carefully!



Symbol for the manufacturer - the manufacturer's name and address are next to the symbol.



The device may not be disposed of in normal household waste. The X on the trash can indicates the necessity of disposing of this device separately. The Vaporizer contains a built-in rechargeable lithium-ion battery that must be discharged before disposal.



EU conformity symbol: The manufacturer confirms with this symbol the compliance of the product with the applicable European directives and standards.



Safety tested and manufacturing monitored by Underwriters Laboratories Inc. according to UL8139.



Caution! Hot surfaces!



Protect from direct sunlight.



Protect against moisture and humidity.



Symbol for serial number.



Symbol for reference number/item number/SKU



DC (direct current)

de

en

fr

es

it

nl

1 FOR YOUR SAFETY



Separate supply unit: To indicate that a specific separate supply unit is required for connecting electrical equipment to the supply mains.

1.2 Legend

- Bullet points
- ▶ Operating instructions
- ⇒ Result

1.3 Important Safeguards

SAVE THESE INSTRUCTIONS.

1.3.1 Basic Rules

- ▶ These Instructions for Use are an integral part of the Vaporizer and must be made available to the user.
- ▶ Download the current detailed version of the Instructions for Use at www.storz-bickel.com.
- ▶ Read these instructions carefully and completely before operating the Vaporizer and USB-C Cable.
- ▶ Always follow the instructions in these Instructions for Use when using and servicing the device.
- ▶ This Vaporizer may only be used by adults. Persons with reduced physical, sensory or mental abilities, or lack of experience and knowledge, should not use the Vaporizer unless they have been given supervision or instruction concerning use of the Vaporizer in a safe way and understand the hazards involved.
- ▶ If the user is suffering from respiratory tract or lung disease, the device may only be used after consultation and with the consent of the treating physician. Depending on their density, the vapors may irritate the respiratory tract and lungs, which may cause coughing.
- ▶ Do not leave the Vaporizer unattended while it is being operated.
- ▶ Store and use the Vaporizer and USB-C Cable only at a sufficient distance from heat sources (oven, stove, fireplace, etc.) and in a dry place where the ambient temperature cannot drop below +5 °C (+41 °F).
- ▶ Do not expose the Vaporizer to extreme fluctuations in ambient temperature. Condensation humidity could interfere with the functionality.
- ▶ Only use original STORZ & BICKEL accessories and spare parts.
- ▶ Do not use the Vaporizer and USB-C Cable in an inappropriate, incorrect or unreasonable manner, as the manufacturer does not accept any responsibility for any damage resulting from this.
- ▶ This device complies with part 15 of the FCC Rules. Operation is subject to the following two conditions:(1) This device may not cause harmful interference, and (2) This device must accept any interference received, including interference that may cause undesired operation.

1.3.2 Safety Recommendations

1.3.2.1 Risk of Injury due to electric shock

- ▶ The Vaporizer and USB-C Cable must be switched off and disconnected from the power supply after use, before any maintenance work and during thunderstorms.
- ▶ Make sure that the USB-C Cable is not damaged by bending, crushing or pulling.
- ▶ Do not use multiple sockets and/or extension cables.
- ▶ Do not use the Vaporizer and USB-C Cable if they are damaged. Repairs may only be carried out by our Service Center. Attempting to repair damage yourself will invalidate the warranty. Our Service Center will replace a defective USB-C Cable.
- ▶ The Vaporizer and USB-C Cable must not be exposed to moisture and humidity.
- ▶ Keep the Vaporizer and USB-C Cable away from pets (e.g. rodents) and pests.
- ▶ Do not use the Vaporizer and USB-C Cable in a potentially explosive or flammable atmosphere.
- ▶ This appliance contains batteries that are not user replaceable.
- ▶ This appliance contains batteries that are only replaceable by skilled and competent staff of our service team.
- ▶ **WARNING:** To charge the battery, use only the detachable Power Adapter available for the device: Model EA1045UR, manufactured by EDAC.

1.3.2.2 Danger of Injury due to Burning/Vapors

- ▶ Do not touch hot surfaces of the Vaporizer (Filling Chamber and the area around the Filling Chamber) during operation and the cooling phase.
- ▶ Place the hot Vaporizer only on a solid and heat-resistant surface and make sure that it is not covered by any objects.
- ▶ Do not use the Vaporizer near inflammable objects such as curtains, tablecloths or paper.
- ▶ Do not close, cover or obstruct the openings of the Vaporizer during operation and the cooling phase.
- ▶ Before switching on the Vaporizer, ensure that all vapors, e.g. from flammable cleaning agents and disinfectants, have evaporated.

1.3.2.3 Risk of Injury due to various Causes

- ▶ The packaging material (plastic bags, polystyrene parts, boxes etc.) must be kept out of the reach of children as it is a potential source of danger.
- ▶ Be careful that small parts of the Vaporizer are not swallowed.
- ▶ Be aware of the danger of strangulation through the USB-C Cable.
- ▶ Only use the Vaporizer with the recommended herbs and plant parts to be vaporized.
- ▶ Monitor your symptoms (e.g., cough, shortness of breath, chest pain) during or after the usage and promptly seek medical attention if you have concerns about your health.

2 VENTY

2.1 Scope of Delivery

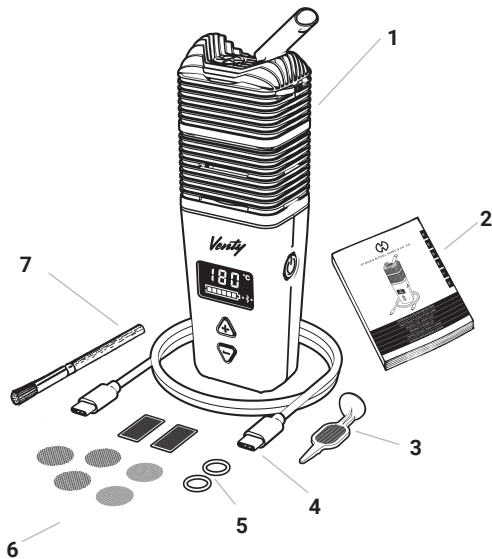

- 1 1 pc. VENTY Vaporizer
- 2 1 pc. Instruction for Use (Concise)
- 3 1 pc. Filling Chamber Tool
- 4 1 pc. USB-C Cable (USB type C to USB type C plug)
- 5 2 pcs. O-Ring $\varnothing 9 \times 1,5 \text{ mm}$
- 6 2 pcs. Normal Screen, small
- 8 3 pcs. Coarse Screen, small
- 9 2 pcs. Cooling Unit Screen
- 7 1 pc. Cleaning Brush

2.2 Functional Elements

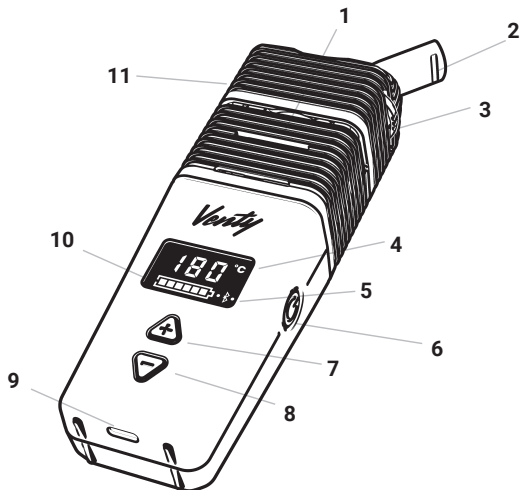

- 1 Filling Chamber
- 2 Mouthpiece
- 3 Setting Wheel for Airflow
- 4 Temperature Display
- 5 Bluetooth Symbol
- 6 Power Button
- 7 Plus Button
- 8 Minus Button
- 9 USB-C Charging Socket
- 10 Battery Display
- 11 Cooling Unit

de

en

fr

es

it

nl

2.3 Cooling Unit

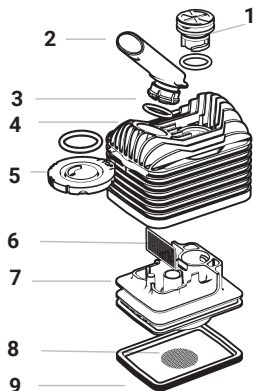

- 1 Rotary Cap
- 2 Mouthpiece
- 3 Mouthpiece Seal Ring
- 4 Cooling Unit Cap
- 5 Setting Wheel for Airflow
- 6 Cooling Unit Screen
- 7 Cooling Unit Base
- 8 Screen (Coarse Mesh Width)
- 9 Cooling Unit Bottom Seal Ring

2.4 Service

- ▶ In case of incomplete delivery, technical problems, questions about the device and its disposal and in warranty cases please contact our Service Center under: www.storz-bickel.com/contact.
- ▶ For service requests, start an RMA (Return Merchandise Authorization) process via our homepage: www.storz-bickel.com/service.

3 INTENDED USE

The Vaporizer is used to produce fragrances or aromas from the herbs and plant parts listed in Chapter 4. The scents and aromas are released by means of vaporization with hot air and can be inhaled directly.

The Vaporizer is not intended for medical-therapeutic purposes.

4 OVERVIEW OF PLANTS

- ▶ Only vaporize fragrances and aromas from the plant materials listed here and which have been tested for authenticity, purity and pathogens according to the guidelines of the European Pharmacopoeia (or comparable). Any other use is inappropriate and potentially dangerous.
- ▶ The Vaporizer is not intended for the use of tobacco or nicotine-related products.
- ▶ Purchase plants or parts of plants in the pharmacy.

Plant name	Botanical name	Portion of the plant used	Temperature setting
Eucalyptus	<i>Eucalyptus globulus</i>	the leaves	130 °C (266 °F)
Hops	<i>Humulus lupulus</i>	the cones	154 °C (309 °F)
Chamomile	<i>Matriarca chamomilla</i>	the blossoms	190 °C (374 °F)
Lavender	<i>Lavandula angustifolia</i>	the blossoms	130 °C (266 °F)
Lemon balm	<i>Melissa officinalis</i>	the leaves	142 °C (288 °F)
Sage	<i>Salvia officinalis</i>	the leaves	190 °C (374 °F)
Thyme	<i>Thymus vulgaris</i>	the herb	190 °C (374 °F)

5 FACTORS INFLUENCING VAPORIZATION

- ▶ Follow the instructions below to ensure that the Vaporizer with the plant material you use is optimally adjusted to your personal needs.

The amount of aromas and fragrances released can be influenced by the following factors:

1. Quality: The amount of aroma or fragrance contained in the respective plant material that can be vaporized.
2. Quantity: The amount of vaporization material in the Filling Chamber.
3. Surface: The finer the plant is ground, the greater the surface and the more aromas and fragrances can be released during the vaporization cycle.
4. Temperature: The higher the temperature, the more aromas and scents are released at once. An increase in temperature should always be a last resort, as the plant material has a more burnt taste at higher temperatures.

6.1 Unpacking

- ▶ Check the Vaporizer for completeness using Chapter 2.1 "Scope of Delivery", page 36.
- ▶ Check the Vaporizer and the USB-C Cable for externally visible damage.

6.2 Battery

NOTICE

**Loss of warranty /
Damage to property if the battery is replaced independently**

Damage to the Vaporizer due to improper opening.

• **For service inquiries contact our service center.**



6.2.1 Basic Explanation of the Battery Display

- ▶ Full battery: Display of all six charging status fields
- ▶ Battery almost empty: Slowly flashing battery frame

6.2.2 Charging the Battery

- ▶ Fully charge the battery before first use.
- ▶ Connect the Vaporizer to a USB-C charger using the USB-C cable supplied.
 - ⇒ Vaporizer vibrates and display lights up.
 - ⇒ Charge status fields flash in an ascending order to indicate charging level.
 - ⇒ As soon as the battery is fully charged, all six charge status fields are visible and the display turns off.

	Charging with a USB - charger	Quick Charge (if supported by the charger)	Charging with a low power charger
Charge status fields	Flash in an ascending order to indicate charging level	Quickly flash in an ascending order to indicate charging level	Slowly flashing in an ascending order to indicate charging level
Additional Display indication	-	-	 (use a more powerful charger)

- ▶ In order to maximize battery life you can activate ECO charging mode through the Web App (www.storz-bickel.com/app/web). Indication on the display during charging:



6.2.3 End of Charging Process

- ▶ When the charging process is finished, first disconnect the USB-C cable from the mains supply and then from the Vaporizer.

6.3 Filling the Filling Chamber

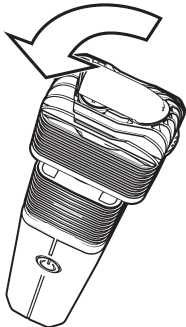

- ▶ Unscrew the Cooling Unit from the Vaporizer by turning it 90° counter-clockwise.

de

en

fr

es

it

nl

6 COMMISSIONING AND OPERATION

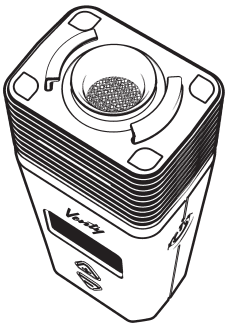

- ▶ Fill the Filling Chamber completely with crushed plant material up to the rim.
- ⇒ Excessively compressed plant material or an overfilled Filling Chamber makes inhalation more difficult.
- ▶ Remove excess plant material around the Filling Chamber.
- ▶ Screw the Cooling Unit onto the Vaporizer by turning 90° clockwise.
- ▶ Alternative: Fill the Dosing Capsules, available as optional accessories, with crushed plant material and insert them into the Filling Chamber with the cap facing upwards.

NOTICE

- The Dosing Capsules can impair the airflow.

6.4 Heating Up

6.4.1 Display

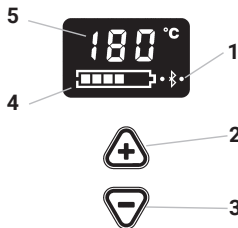

- 1 Bluetooth Symbol
- 2 Plus Button
- 3 Minus Button
- 4 Battery Display
- 5 Temperature Display

6.4.2 Default Settings

The Vaporizer offers three factory preset temperature levels:

- Base Temperature: 180 °C (356 °F)
- Booster Temperature offset: +15 °C (+27 °F)
(relative to the Base Temperature) corresponds to 195 °C (383 °F)
- Superbooster Temperature offset: +15 °C (+27 °F)
(relative to the Booster Temperature) corresponds to 210 °C (410 °F)
- ▶ Base Temperature and Booster Temperature , such as the Superbooster Temperature can be changed individually (Booster and Superbooster Offset only through the Web App).
- ▶ If one temperature level is no longer sufficient, switch to the next level as described in the following spreadsheet (page „6.4.4 Adjusting Temperatures“ auf Seite 44).

6.4.3 Switching on

- ▶ Press the Power Button for at least half a second.
- ⇒ Vaporizer vibrates and display lights up.
- ⇒ The display indicates the heating process by showing the Set Temperature in an orange color. Depending on battery charge level, ambient temperature, unit and filling quantity/material in the Filling Chamber, this can take at least 17 seconds.
- ⇒ A double vibration signal and the green display light indicate that the Base Temperature has been reached.

de

en

fr

es

it

nl

6 COMMISSIONING AND OPERATION

6.4.4 Adjusting Temperatures

	Base Temperature (180°C/356°F as default)	Booster Temperature (+15°C/27°F)	Superbooster Temperature (+15°C/27°F)
Activate	Is automatically active when device is turned on by pressing the Power Button.	By double pressing the Power Button. Deactivates after 90s and goes back to your set Base Temperature.	By double pressing the Power Button when starting point is the Booster Temperature. Deactivates after 90s and goes back to your set Base Temperature.
Indication	<ul style="list-style-type: none"> ▶ Display shows set temperature ▶ Orange display light during heat up. ▶ Green light and double vibration when temperature is reached. 	<ul style="list-style-type: none"> ▶ Display shows Booster Temperature (Base Temperature +15°C/27°F) ▶ °C/°F symbol flashes during heat up. ▶ Green display light and double vibration when temperature is reached. 	<ul style="list-style-type: none"> ▶ Display shows Superbooster Temperature (Booster Temperature +15°C/27°F or Base Temperature +30°C/54°F) ▶ °C/°F symbol flashes quickly during heat up. ▶ Green display light and double vibration when temperature is reached.
Press the + or - button briefly	Changes temperature in 1° steps between 40°C and 210°C (104°F and 410°F).	<ul style="list-style-type: none"> ▶ Changes temperature in 1° steps. ▶ Temperature offset can be adjusted through the Web App. (www.storz-bickel.com/app/web) 	<ul style="list-style-type: none"> ▶ Changes temperature in 1° steps. ▶ Temperature offset can be adjusted through the Web App. (www.storz-bickel.com/app/web)
Press and hold the + or - button	Changes temperature by continuously and fast running numbers until button is released.	Changes temperature by continuously and fast running numbers until button is released.	Changes temperature by continuously and fast running numbers until button is released.

By double pressing the Power Button in Superbooster Temperature you get back to Base Temperature.

6.4.5 Celsius/Fahrenheit

- ▶ Press the plus and minus buttons simultaneously for 3 seconds.
- ⇒ Display changeover from Celsius to Fahrenheit and vice versa.

6.4.6 Display Backlight

- ▶ Press the plus and minus buttons simultaneously for 5 seconds.
- ⇒ Display backlight can be changed between step 0 to 9.

6.4.7 Bluetooth

- ▶ Press the Power and minus button simultaneously.
- ⇒ Display shows "bLE"
- ⇒ Disables Bluetooth on your Vaporizer (Bluetooth Symbol is not visible anymore)
- ▶ Press the Plus Button, while "bLE" is shown on the display.
- ⇒ Enables Bluetooth on your Vaporizer (Bluetooth Symbol is visible).

6.4.8 Reset to Default Settings

- ▶ Press the Power Button for 10 seconds.
- ⇒ A vibration and a reset animation indicate the reset.
- ⇒ The Basis and Booster Temperature, such as the Superbooster Temperature are reset to factory settings.

6.5 Application

- ▶ Once the heating process is complete, start vaporization immediately.
- ▶ Fold out the Mouthpiece.
- ▶ Put the Mouthpiece between your lips.
- ▶ Inhale evenly for a few seconds and only half as much as possible.
- ▶ Hold your breath for a few seconds.
- ▶ Slowly exhale.
- ▶ Conscious concentration on the breathing process.
- ⇒ The higher the temperature, the greater the impairment of the flavor.

**CAUTION****High intensity of vapors**

Irritation of the respiratory tract/lungs

- Reduce temperature.

6.6 Adjustable Airflow

The Vaporizer has an adjustable airflow, which can be adjusted steplessly with the help of the Setting Wheel (with constant draft resistance).

- ▶ Turn the Setting Wheel to one notch: The opening is almost closed
 - ⇒ Low airflow
- ▶ Turn the Setting Wheel to two notches: The opening is half open
 - ⇒ Medium airflow
- ▶ Turn the Setting Wheel to three notches: The opening is completely open
 - ⇒ High airflow

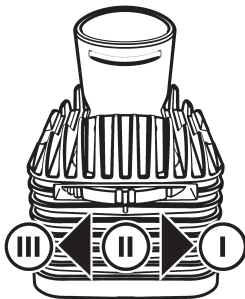

6.7 End of Application



CAUTION

Hot surface of the Filling Chamber

Caution! Hot surface!

- **Do not touch the Filling Chamber until the Vaporizer has cooled down.**

- ▶ Press the Power Button for at least half a second.
 - ⇒ Vaporizer vibrates and switches off.
- ▶ Let the Vaporizer cool down completely. The cool down process is displayed through blue display light.
- ▶ If necessary, clean the Vaporizer as described in Chapter 7 "Cleaning/Hygiene", starting on page 49.

6.8 Automatic Switching Off

Two minutes after the last keystroke or the last application, the Vaporizer switches off automatically to conserve battery power.

- ⇒ Switching off is indicated by vibration.
- ▶ Press the Power Button briefly during operation.
- ⇒ Automatic switch off is reset to two minutes.

6.9 Storage

- ▶ Store the Vaporizer and USB-C Cable in a dry place away from the elements and out of reach of children or unqualified persons.

6.10. STORZ & BICKEL Web App

The STORZ & BICKEL Web App is not necessary for the operation of the Vaporizer, but allows individual settings and the reading of additional information during operation with the Vaporizer.

To do that, connect the Vaporizer to a smartphone via **Bluetooth®**.

6.10.1. Connecting the Vaporizer with a Smartphone

Switch on the smartphone and ensure that the **Bluetooth®** function is switched on and that it is not blocked by another **Bluetooth®** device. Then switch on the Vaporizer and open a browser which supports **Bluetooth®** connectivity (more information on www.storz-bickel.com/app/web).

Go to app.storz-bickel.com.

Click "Connect" and choose your Vaporizer.

6.10.2. The Menu Items of the STORZ & BICKEL Web App

Temperature:

Temperatures can be set on the device itself as well as through the STORZ & BICKEL Web App.

Temperatures can be set between 40°C-210°C (104°F-410°F) in the same way as on the interface of the device, see Chapter 6.4.4. Adjusting temperatures.

de

en

fr

es

it

nl

Fahrenheit/Celsius

Click on the temperature to change from degree Celsius to degree Fahrenheit and vice versa.

Device

Device-related information, such as operating hours, software versions etc. can be found in this section.

To find out which additional device specific features can be adjusted through the STORZ & BICKEL Web App, visit: <https://www.storz-bickel.com/app/web>

7.1 Cooling Unit

Cooling Unit with Mouthpiece must be free of deposits. Deposits on the inside of the Cooling Unit are mainly caused by steam condensate. Cleanliness is a prerequisite for proper function.

- ▶ Check the Cooling Unit with Mouthpiece prior to each use.
- ▶ Clean the Cooling Unit with Mouthpiece no later than 7 days after the last use and if deposits are visible on the inside of the Cooling Unit.

7.1.1 Disassembling the Cooling Unit

- ▶ Pull the Mouthpiece out of the Cooling Unit Cap while slightly tilting it back and forth.
- ▶ Pull off the Mouthpiece Seal Ring using the recess.



- ▶ Put the edge of the Mouthpiece into the notch at the Rotary Cap and turn it counterclockwise to open and pull out. Pull off the Seal Ring from the Rotary Cap using the recess.

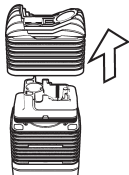

- ▶ Pull the Cooling Unit Cap off the Vaporizer

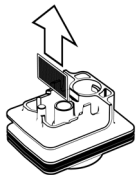

- ▶ Pull out the Screen inside the Cooling Unit.



- ▶ Use the Filling Chamber Tool to press the Setting Wheel out of the Cooling Unit and let the Seal Ring fall out.

de

en

fr

es

it

nl

7 CLEANING / HYGIENE

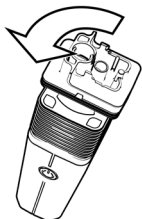

- ▶ Unscrew the Cooling Unit Base from the Vaporizer by turning it 90° counterclockwise.

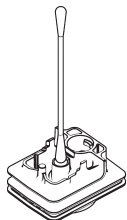

- ▶ Carefully press out the Screen from above using a cotton swab.

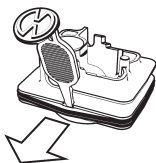

- ▶ Lever out the large Base Seal Ring with the Filling Chamber Tool at the recess in the groove.

7.1.2 Cleaning the Cooling Unit and the Filling Chamber Screen

- ▶ Use the Cleaning Brush and cotton swabs and paper or cotton cloths for manual cleaning.
- ▶ Use warm rinsing water or isopropyl alcohol as a solvent.
- ▶ Clean the Filling Chamber Screen and the Screen of the Cooling Unit with the Cleaning Brush after each use.

7.1.2.1 Cleaning the Cooling Unit and the Filling Chamber Screen with rinsing water

- ▶ Place all parts in warm rinsing water for at least five minutes.
- ▶ Rinse all parts under running water for at least one minute.
- ▶ Let all parts dry completely.

7.1.2.2 Alternative: Cleaning the Cooling Unit and the Filling Chamber Screen with Isopropyl Alcohol**⚠ CAUTION**

Isopropyl Alcohol is flammable and may easily ignite

Caution! Hot surface!

- Follow the safety instructions of the isopropyl alcohol manufacturer!

NOTICE

Material damage caused by improper cleaning

Embrittlement of plastic parts

- Soak plastic parts in isopropyl alcohol for maximum 1/2 hour.

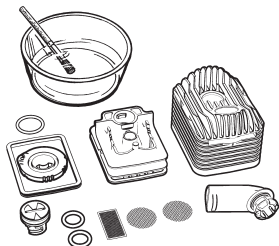

- ▶ Place all parts of the Cooling Unit and the Filling Chamber Screen in isopropyl alcohol for a maximum of 1/2 hour.
- ▶ Rinse all parts under running water for at least one minute.
- ▶ Let all parts dry completely.

7.1.3 Check the Cooling Unit Parts and the Filling Chamber Screen

- ▶ Check all parts for damaged surfaces, cracks, softening, hardening, embrittlement, contamination or discoloration.
- ▶ Discard damaged parts.

7.1.4 Assembling the Cooling Unit



CAUTION

Plant particles in the Cooling Unit

Clogging of the Cooling Unit

Inhalation of plant particles

- **Insert the Screen correctly into the Cooling Unit Base.**

- ▶ Assemble the parts in reverse order.
- ▶ Place the Seal Ring just on top of the Setting Wheel for Airflow and make sure that the "TOP" label is inserted upwards.
- ▶ When assembling, make sure that Seal Rings are properly seated.
- ▶ Insert Screen in the groove provided for this purpose.

7.2 Filling Chamber

7.2.1 Cleaning the Filling Chamber

- ▶ Clean the Filling Chamber with a cotton swab soaked in isopropyl alcohol.

NOTICE

Material damage caused by improper cleaning

Ingress of isopropyl alcohol into the Vaporizer

- **Do not moisten cotton swabs too much.**

7.2.2 Removing the Screen

- ▶ If a Screen is clogged, it must be replaced.
- ▶ Press in the Screen, using the Filling Chamber Tool along the groove of the Filling Chamber.
 - ⇒ The Screen bulges and detaches from the groove.
- ▶ Clean the Screen with rinsing water or isopropyl alcohol.

7.2.3 Installing the Screen

- ▶ Bend the cleaned Screen beforehand or use a new Screen.
- ▶ Insert the Screen into the Filling Chamber with the curved side facing upwards.
- ▶ Press the Screen flat into the provided groove with the aid of the Filling Chamber Tool.

7.3 Cleaning the Vaporizer and the USB-C cable

NOTICE

Material damage caused by improper cleaning

Ingress of water into the Vaporizer or the USB-C cable

- **Do not immerse in water or other liquids.**
- **Do not clean with direct water or steam jet or compressed air.**

- ▶ Switch off the Vaporizer
- ▶ Disconnect the Vaporizer and the USB-C cable from the mains supply
- ▶ Clean the housing of the Vaporizer and the USB-C cable only with a dry soft or damp cloth.

de

en

fr

es

it

nl

8 OPTIONAL ACCESSORIES

8.1 List of optional accessories

Wear & Tear Set - SKU 11 64

The Wear & Tear Set contains three Mouthpieces, one Cooling Unit, one Screen Set, two Filling Chamber Tools and a Cleaning Brush.

Coolings Units, 3 pieces - SKU 11 63/ Cooling Unit - SKU 11 62

The Cooling Unit cools down the vapor and thus provides a pleasant temperature and an optimal aroma. To ensure cleanliness of the Cooling Unit, it should be replaced regularly.

Mouthpieces, 4 pieces - SKU 11 71

The Set includes four Mouthpieces for the Cooling Unit.

Screen Set, small - SKU 11 94

Our Screen Set includes all the necessary spare screens for your Vaporizer. Clogged screens might impair airflow and taste, which is why they should be regularly replaced.

Coarse Screens, 6 pieces - SKU 11 40

The Set includes six coarse mesh Screens

Normal Screens, 6 pieces - SKU 11 03

The Set includes six normal mesh Screens.

Seal Ring Set - SKU 11 82

The Set contains all the sealing rings for the Cooling Unit and Filling Chamber.

Herb Mill - SKU 09 30 / Herb Mill XL - SKU 09 43

The Herb Mill has extra sharp cutting teeth for finely ground plant material.

Filling Chamber Tools, 5 pieces - SKU 11 59

The various application options of the Filling Chamber Tool are described in these Instructions for Use.

Dosing Capsules, 40 pieces -SKU 09 33

Crushed plant material can be filled into the Dosing Capsules. Dispose of the Dosing Capsule after use in household waste.

Dosing Capsule Magazine - SKU 09 32

Store the filled Dosing Capsules in the Magazine. The Magazine Cap serves as a filling aid for the Dosing Capsules.

Dosing Capsule Filling Set - SKU 09 45

The Filling Set is designed for the simultaneous filling 40 Dosing Capsules with ground plant material.

Cleaning Brushes, 3 pieces - SKU 11 24

The Cleaning Brush is used to clean the Filling Chamber, among other things.

USB-C Supercharger - SKU 11 47

Thanks to the four interchangeable plugs the USB-C Supercharger can be used almost anywhere in the world. The USB-C Supercharger enables fast charging of the device.

You can find these and other accessories as well as detailed information about these products under <https://www.storz-bickel.com> or contact our Service Center: 0049-(0)7461-969707-0.



9.1 Possible Faults / Troubleshooting

Vaporizer cannot be switched on	Device is empty.	<ul style="list-style-type: none"> ▶ Check battery display. ▶ Charge battery if necessary.
ERR 001	Device temperature is too high.	<ul style="list-style-type: none"> ▶ Let the Vaporizer cool down.
ERR 002	Device temperature is too low.	<ul style="list-style-type: none"> ▶ Move the Vaporizer to a warm environment. ▶ Do not heat the Vaporizer with an external heat source such as a stove, microwave or lighter.
ERR 003	USB charger or USB-C cable is not suitable.	<ul style="list-style-type: none"> ▶ Use original STORZ & BICKEL accessories.
ERR 004	The Vaporizer is faulty.	<ul style="list-style-type: none"> ▶ Switch off the Vaporizer immediately. ▶ Pull out the plug. ▶ Contact our Service Center.
ERR 005	It was blown into the Vaporizer.	<ul style="list-style-type: none"> ▶ Be careful not to exhale back into the Vaporizer for future operations.

de

en

fr

es

it

nl

10 TECHNICAL SPECIFICATIONS

10.1 Vaporizer

Supply voltage: 5 VDC USB / 5-15 VDC USB-C PD

Power consumption: 130 W max.

Operating temperature: 5 °C - 35 °C (41 °F - 95 °F)

Temperature range: 40 °C - 210 °C (104 °F - 410 °F)

Size: 15,7 x 5,5 x 3,7 cm (6.18 x 2,17 x 1.46 inch)

Weight: approx. 252 g (0.56 lbs)

Frequency band: 2,4-GHz-ISM-Band (2400 to 2483,5 MHz)

Maximum transmitting power: +5.3 dBm EIRP

Patents and designs: www.storz-bickel.com/patents

Subject to technical changes.

10.2 Technical Requirements for suitable Chargers

- For general charging, a USB charger with at least 5 VDC / 2 A (10 W) is recommended.
- Technical requirements for supercharging:
Charger must support USB-C PD and supply at least 9 VDC / 3 A (27 W).

11 COMPLIANCE WITH LEGAL AND NORMATIVE REQUIREMENTS

The devices complies with the following EC Directives:

- 2014/30/EU
- 2014/53/EU
- 2011/65/EU

Identifier for compliance of the radio module:

- FCC-ID: 2APJE-SBYY
- IC: 23679-SBYY



Manufacturer:

STORZ & BICKEL GmbH
In Grubenäcker 5-9
78532 Tuttlingen, Germany

11 COMPLIANCE WITH LEGAL AND NORMATIVE REQUIREMENTS

11.1 Simplified EU Declaration of Conformity

We, STORZ & BICKEL GmbH, hereby declare under our sole responsibility that the VENTY is in conformity with the regulations 2014/30/EU, 2014/53/EU and 2011/65/EU.

The full text of the EU Declaration of Conformity can be obtained at the following internet address:
<https://www.storz-bickel.com/downloads>

12 WARRANTY, LIABILITY, COPYRIGHT

12.1 Warranty

We are liable for defects as to quality or title for delivery items pursuant to the applicable statutory provisions, in particular Sections 434 ff. BGB (German Civil Code). The period of limitation for statutory claims for defect is twenty-four (24) months and shall begin when the products are delivered.

An additional warranty applies to products delivered by us only if it is included with the delivery items. As defined, warranty claims apply in addition to claims for defects as to quality or title. Details on the extent of such warranties are provided in the warranty conditions. STORZ & BICKEL GmbH guarantees end customers in accordance with the following provisions that the product that has been delivered to the customer is free from defects in material, of manufacturing or construction faults within the time period of two (2) years from the date of delivery (warranty period).

STORZ & BICKEL GmbH shall remedy any defect or fault claimed under the aforementioned warranty at its sole discretion and own cost by repair, replacement with new or refurbished individual parts or delivery of a defect-free product of the same kind and type.

The warranty does not include parts that are particularly affected by wear and tear and accessories included with the products. Any other customer claims against STORZ & BICKEL GmbH, especially for compensation are excluded.

Claims under this warranty can only be asserted if the customer registers the product within one year as of the delivery at www.storz-bickel.com/registration. Warranty claims shall be voided if the product has not been registered within one year.

Please find all warranty conditions here: www.storz-bickel.com/legal/warranty.

12.2 Liability

We are liable pursuant to the provisions of the German Product Liability Act as well as in cases of failure or impossibility that we are responsible for. In addition, in the case of a specifically expressed guarantee, we shall be liable for intentional and grossly negligent violations of duty and any injuries to life, body or health that we are responsible for. For property damages and financial loss due to ordinary negligence, we shall be responsible only in the event of violation of material contractual obligations (so-called cardinal obligations), i.e. an obligation, fulfillment of which allows contract performance in the first place and compliance with which the customer normally relies on and may rely on, however, limited to the foreseeable damage typical for the contract. In any other case, our liability is excluded.

The extent that our liability is excluded or restricted also applies to the personal liability of our employees, legal representatives and vicarious agents.

12.3 Copyright

This document is copyright protected, and may not be used either in whole or in part pursuant to Sections 15 et seq. UrhG (German Copyright Act) without prior written approval of STORZ & BICKEL.