

Free to move

Opportunities for
new ergonomics
in digitalised offices

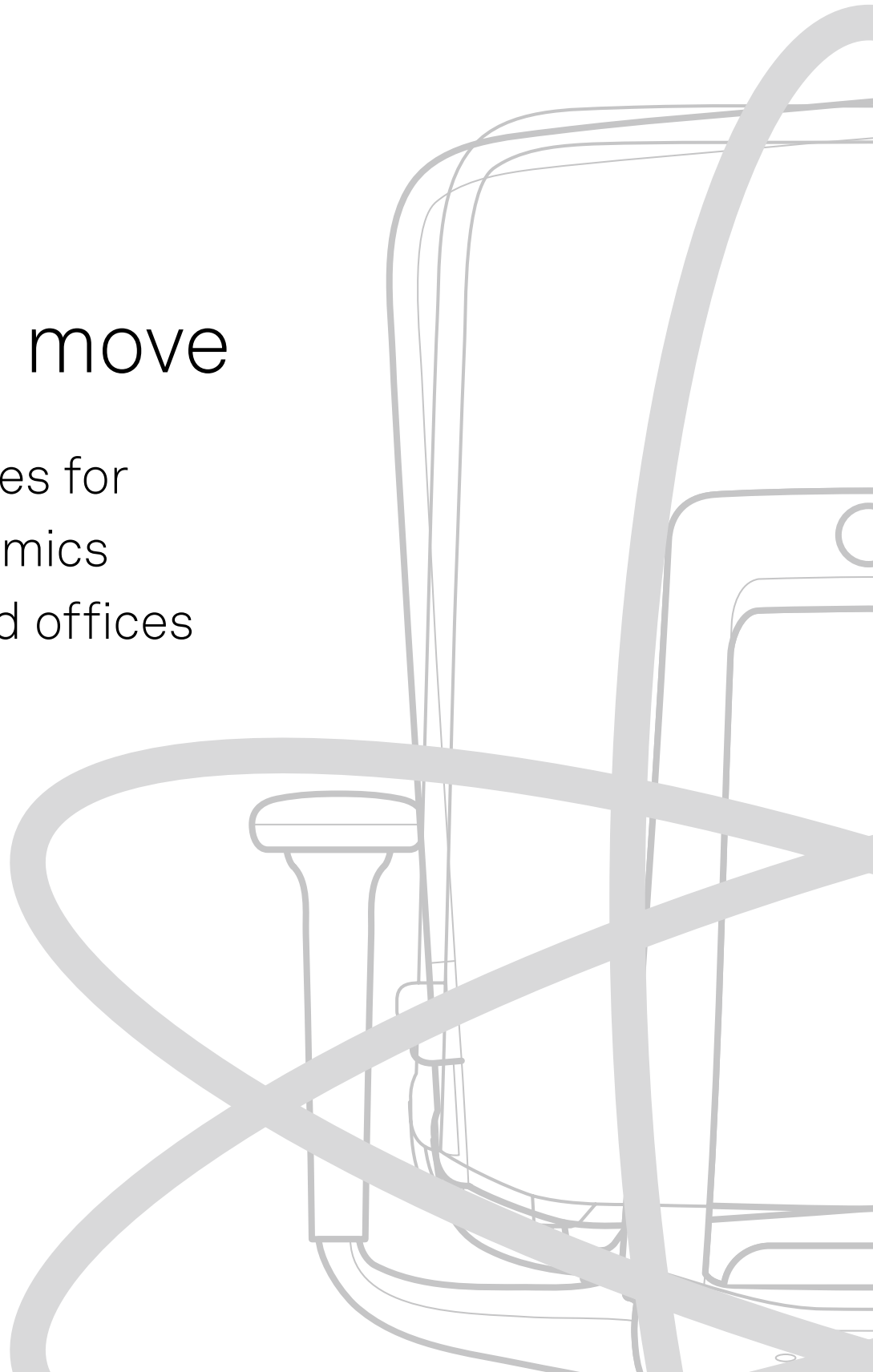

Fresh approaches to new office environments



In view of the competition for skilled and talented people, longer working lives and increasing problems with health, virtually all industries and organisations are facing new challenges and issues when designing workspaces. How can design boost a company's appeal and increase employee loyalty and motivation? How can it encourage communication, collaboration and learning? And how does it keep the workforce as healthy and productive as possible until people retire?

The answers lie in a complete rethink of virtually all office processes customary to date. This equally applies to ergonomics: the media reports again and again on the rise of backache and metabolic complaints resulting from people living and working in environments that are too static. WHO, the World Health Organisation, even categorises long periods of sitting as a health risk all of its own. Because if movement in digitalised offices is confined to typing on a keyboard and using a mouse, even an ergonomically "correct" posture will mean a comatose lack of stimulation. On the other hand, focusing on concentration and the fingers' fine motor skills also decreases strain on the body. Therefore, encouraging movement while sitting is one of the most effective ways of ensuring digitalised offices aren't environments plagued by a lack of physical activity. Which is why we've developed the Free-to-move concept that starts when we're sitting at desks but doesn't stop there by any means. We've included all the key information, issues and solutions in this brochure and will reveal how workspace design ensures greater agility for body and mind. Why not browse through it as a source of inspiration and discover how to reconcile the opportunities of digitalisation with our bodies' natural capabilities?

A handwritten signature in black ink, reading "Jochen Hahne". The signature is fluid and cursive, with a long horizontal stroke at the end.

Dr Jochen Hahne,
President

Digitalisation as an innovation driver

A changing world



Everybody's asking how to design the digital future successfully, whether it's at major research organisations' annual conferences, change and human resources congresses on corporate development or conferences on innovation and future opportunities, in industry or in the world of politics.

Digitalisation of almost all working processes places people at centre stage in terms of value creation in a knowledge-based economy. At the same time, nobody needs to work in a particular room or at a specific time, which allows new freedoms, but also entails new risks in terms of data privacy or retaining employees for instance. The major tech corporations as key drivers of the technological transformation are advocating mobile nomadic styles of working on the one hand, but they're also investing a lot of creativity and money in designing their own office environments on the other. For good reason: because in the digital economy in particular, making the office a collaborative place is becoming ever more crucial in order to attract the best talents, maintain internal networking and innovation speed at a high level and to increase intellectual performance.

The background: body and mind caught between the Stone Age and high-tech era

Because technological progress occurs while we're sitting...

Although crouching, standing, running or lying down is part of our DNA, sitting has become second nature to us. We think it's natural to sit down in private or public anytime and anywhere – whether at home or at work. Even travelling about by bus, train, plane or car involves taking a seat. It's clear that comfort and convenience are key drivers of technological growth. Because the history of mankind's struggle to survive has anchored the principle of saving calories as a natural way of conserving energy. As a result, areas where physical activity take place, types of physical activity and its duration have shrunk. Mankind started moving for 10 to 12 hours daily in a variety of ways while hunting and gathering. Then we settled down in one place to farm the land. Then came industrialisation and its way of sharing work, which also led to shorter distances covered in offices and the idea of putting objects in places that could be reached easily and efficiently. Over the last few years, with the advent of digitalisation and its tools, movement has been reduced to our fingers, two-dimensional desktops and touchscreen displays. With serious consequences for our health: long-term illnesses among white collar workers now account for just under 40% of days lost to sickness. On average, each employee is written off sick for about three weeks a year.

“Despite hard work done on company health management programmes, there’s been no significant improvement. We need to join forces with companies to make each environment more back-friendly – and reintroduce more physical activity in the workplace.”

Andreas Storm, publisher of the German DAK health insurer’s health report



...our muscles, our body's metabolic powerhouse, are struggling and our ability to cope with stress dropping.

Musculoskeletal complaints are the number one cause of days lost to sickness. According to the German health-care insurer DAK's 2018 health report, 75% of all employees have backache at least once a year and one in seven has already been suffering from it for three months or more.

It's quite obvious that our bodies aren't adequately stimulated at work or during our spare time to keep them healthy. Renowned health and sports scientists like Professor Ingo Froböse from the German Sport University Cologne point out that all physical skills will wither if they're not stimulated regularly. He comments that some 80% of backache is no longer the result of overtaxing our bodies but of lack of stimulation. The muscles are considered the biggest metabolic powerhouse and controlled by around 60 million stimulus receptors in the body. If these stimuli are missing, muscles atrophy, metabolic rates drop and the whole body becomes sluggish. In the long term, joints and bones degenerate and our immune systems are weakened. Because mind and body are closely linked. Mental illness is the second reason for days lost to sickness and usually means that people are absent for especially long periods. Where women are concerned it's also top of the list of illnesses. The frequent combination of too much constant stress and a lack of physical activity have an exceptionally negative impact as stress hormones are no longer effectively curtailed if metabolic rates are poor and the immune system is damaged in the long term.

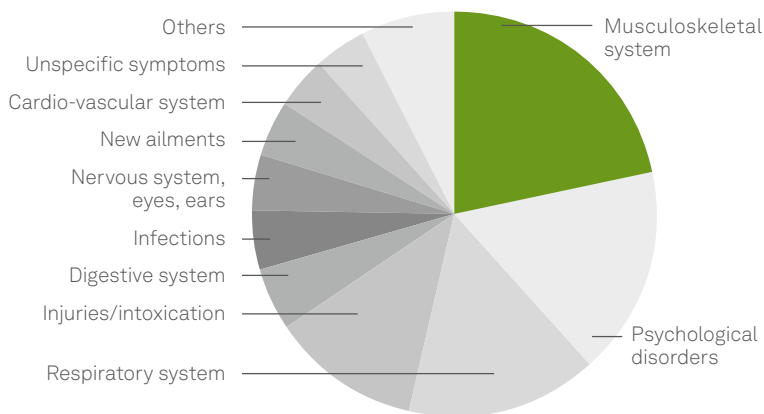

Proportion of days lost to sickness according to types of illness.

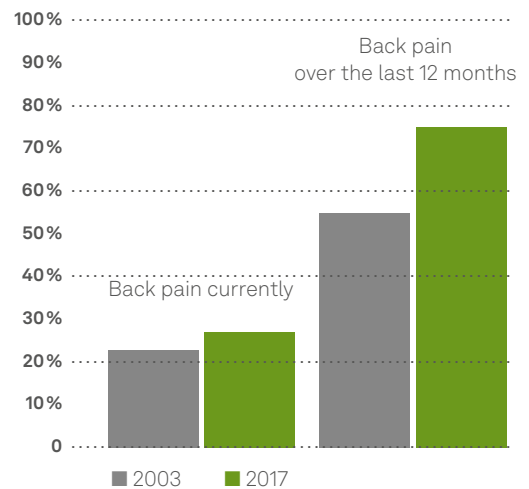

Source: DAK 2018 Health Report



Whether people are young or old, tall or short, weigh a little more or less, everyone wants to relax by sitting down – whenever, wherever and however possible.

New ergonomics: sitting as we want to and can

From posture-based to movement-based approaches

What does all this mean for sitting? Just under 40 years ago, we cultivated dynamic sitting with the legendary FS-Line office chair range that's still popular today. For many years now, ergonomists have agreed that the best posture to adopt while sitting is always the next one. At the same time, the idea of the "correct" sitting posture is still being propagated and encountered in office chair classifications. The more the better seems to be the motto with numerous adjustment options available and marketing strategies proclaiming perfect customised adjustments and relaxing the body as much as possible – which is a contradiction in itself. Because a supportive straight jacket provides no stimulation and weakens muscles. And any effort required to change posture is thwarted. Which is why healthcare researchers focus on stimuli and a natural range of motion as part of new sitting ergonomics. Any pain-free posture that the body can adopt, any movement it can make is considered important and right as long as it isn't permanent: from sitting upright to lounging about. The rules of thumb is the more frequent changes of posture and more varied and natural the movements, the better the metabolism, coordination skills and performance are encouraged while seated.

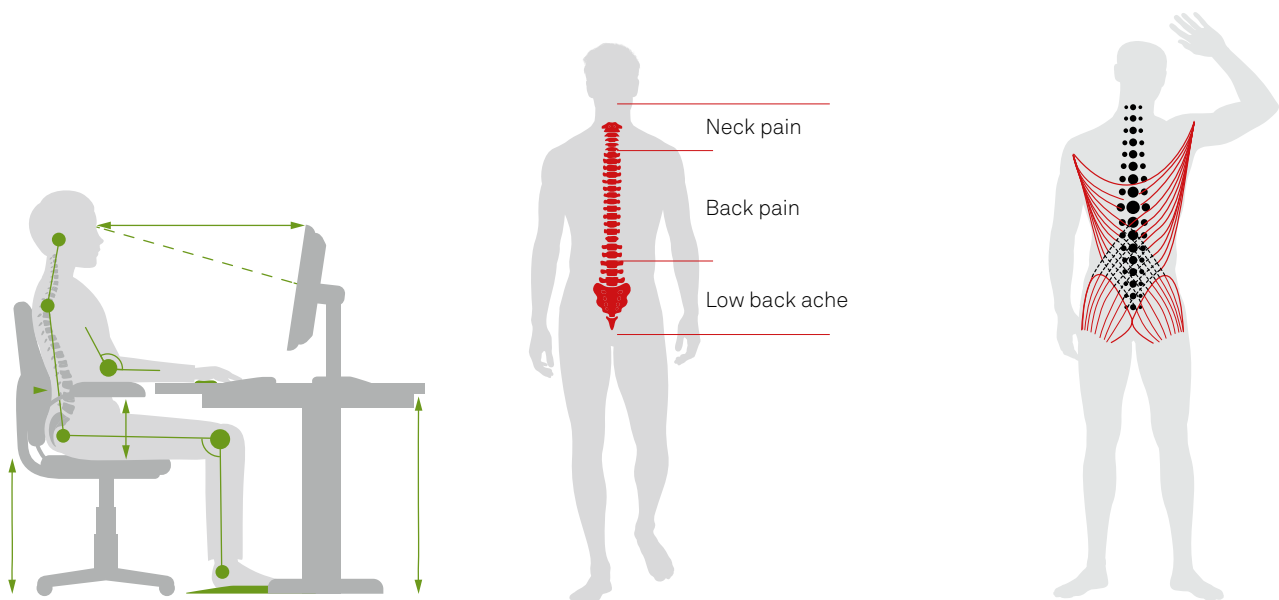

The fallacy of posture-based ergonomics: the idea of the "correct" posture of sitting upright comes from the 19th century and scientists have long since dismissed it as outdated.

Life is movement - which is why any static posture leads to seized-up muscles and degeneration of the musculoskeletal system.

The more muscles that are activated and coordinated by movement, the better our whole body is.

Free to move: freedom to move in digital office workspaces

The brief: to teach seating to walk

There's one thing that physiotherapists, ergonomists and orthopaedists agree on: our bodies are primarily designed for walking. Which is why our joints, muscles and metabolism need as frequent and varied a range of motion as possible. These movements start in our hips, the body's powerhouse. The previous concepts for dynamic sitting reflected these aspects unsatisfactorily. Bending and stretching our torso is much better than no movement at all, but it still means we don't make any vital movements such as rotating our pelvis and the healthy impact this has on our body as a whole. Which is why, as specialists with four decades of experience developing dynamic sitting, our goal was to develop office chairs that enable 3D dynamic movement and therefore teach sitting to walk.



The solution: the Free-to-move concept of sitting kinematics powered by Trimension®

In conjunction with researchers at the German Sport University Cologne, we developed our patented Trimension®, which has now had an excellent track record and been in use over 500,000 times for almost ten years. Due to the pivotal points for the hip joints and the sliding joints near the knees, it mobilises the natural flexibility of the hips, stimulates muscles deep in the back and activates large muscle loops from the joints in the feet to the shoulders. This perfectly coordinated movement concept ensures fluid movements in all directions, but always allows the body to maintain its centre of gravity, whether we bend down, stretch, lean sideways or rotate our pelvises. As a result, the slightest of shifts in weight mean we change posture to stimulate the whole body: the discs in the spine as well as the joints and the muscles as the body's most important metabolic powerhouse.

**Our classic ON® chair
with the touch of prestige**

The chair encourages movement and a change of posture and comes as a broad product family destined for high-end front offices and conference rooms.

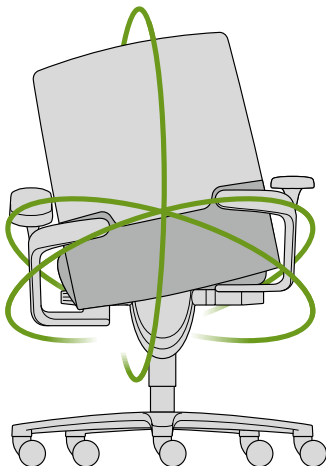

Our athletic and dynamic IN chair

This chair's a master of motion and impressive for its direct control feature, ability to adjust to people weighing between 45 to 140 kg and varied colour scheme.

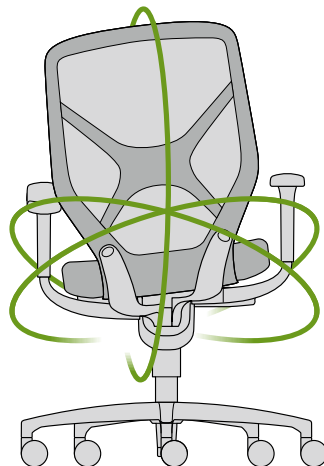

Our smart AT all-rounder

This chair's automatic weight adjustment, integrative design and range of models make it ideal for flexible office concepts with hot desking.

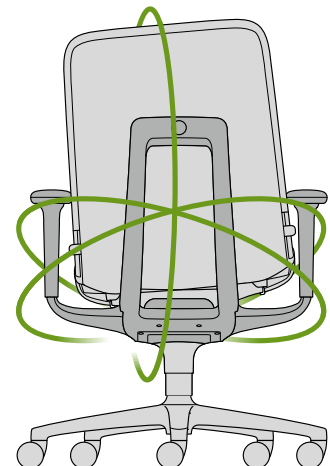

Free-to-move powered by Trimension®: a healthier, more effective solution

Borne out by three scientific studies

The renowned Centre for Health at the German Sport University Cologne didn't just monitor and verify the concept surrounding Trimension®, but also its impact on the body. The researchers presented the latest of three studies at the 21st Annual Applied Ergonomics Conference 2018 in Atlanta, which is organised by GOErgo, the Global Organization of Ergonomics. All studies prove that Free-to-move, powered by Trimension®, is a concept that's healthy, mirrors our bodies' movements, encourages a feeling of well-being and quickly pays dividends because people are more productive.



Lab study:

It looked at how the concept correlated with our bodies, the biomechanical impact and the subjective feeling of comfort that Trimension® provides in the ON® office chair.

Results:

- Pressure is distributed evenly while people are sitting and is perceived to be very comfortable.
- By flexing, extending, flexing sideways and rotating the pelvis, Trimension® stimulates the body to engage in a range of natural movements where the head, shoulder and pelvis form a functioning unit when moving with the chair.
- In addition to the large muscle loops, the physiological rotation of the torso activates the muscles deep in the back, the most important component in stabilising the spine.
- Some 90% of the test persons would like this sort of sitting concept in their workspace, so that the typical complaints associated with sitting at desks won't come about.

Conclusion drawn by the university:

Free-to-move, powered by Trimension®, coordinates with the body's natural range of motion and encourages it to try out new dimensions of flexibility. Typical complaints associated associated with static sitting at desks won't arise in this case.

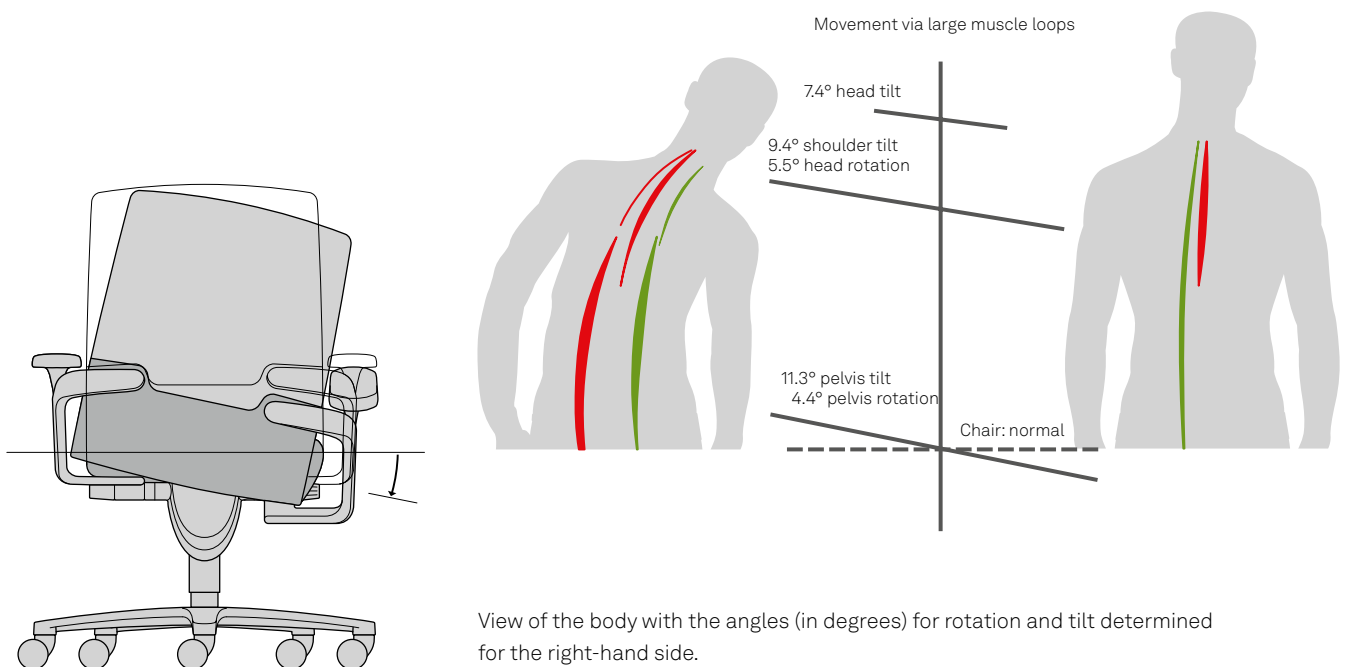

Comparative field study:

The researchers then investigated whether, alongside well-being, this sitting concept while using ON® also boosted people’s performance. The study was carried out with 80 test persons in an insurance company’s office complex over a period of 12 weeks. Recognised, standard tests and questionnaires were used to identify powers of concentration.

Results:

- Compared with the control group, the powers of concentration among the Free-to-move group had improved significantly where all metrics are concerned after just three months. They were faster, made fewer mistakes and worked more consistently.
- After a short space of time, the Free-to-move group got used to the new movement options and liked them.
- The Free-to-move group’s well-being due to the new sitting concept didn’t just improve in relative but in absolute terms too.

Conclusion drawn by the university:

The Free-to-move concept of dynamic sitting is used frequently and intuitively and what’s more, pays dividends in terms of better powers of concentration in a short space of time!

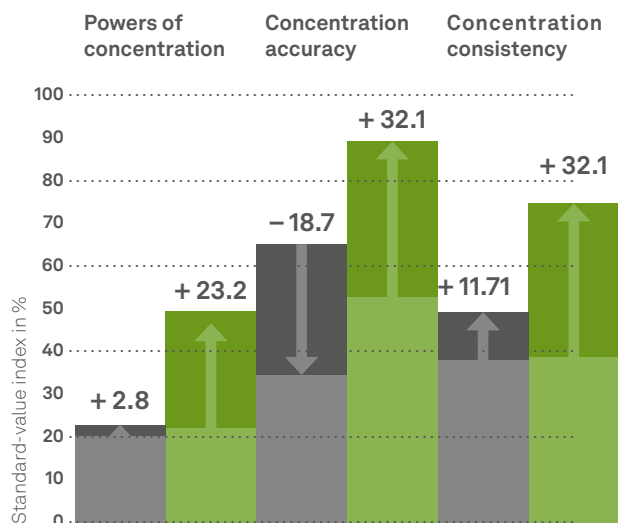

Development of powers of concentration by the control group (grey) with conventional office chairs and the trial group (green) with three-dimensional ON chairs over a period of three months.

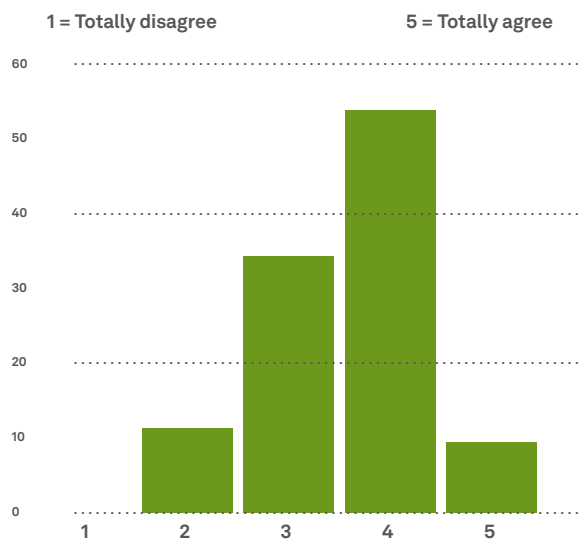

My sense of physical well-being has improved thanks to ON over the past 11 weeks

Source: Centre for Health at the German Sport University Cologne

A study on the impact of Trimension 3D kinematics on dorsal muscles, the range of motion and physiological stimulation

New measurement methods were applied based on standardised office working processes (static and dynamic) to examine metabolic activity in the particularly important lumbar muscles used in offices. The results on the Free-to-move IN office chair were compared with those on the very good 2D dynamic Neos office chair.

Results:

- The test persons used all the three-dimensional range of motion offered by Trimension®.
- Where lateral flexion's concerned, there are significant differences between a 2D synchro-adjustment mechanism and Trimension.
- The important switch between tensing and relaxing muscles is much higher in the Free-to-move concept IN office chair than in a comparable one.
- The test persons prefer the Free-to-move office chair on all criteria.

Conclusion drawn by the university:

Dynamic sitting on IN with Trimension® verifiably leads to healthy lumbar muscles. So there's a justifiable reason to assume that backache originating from our muscles can be decreased.

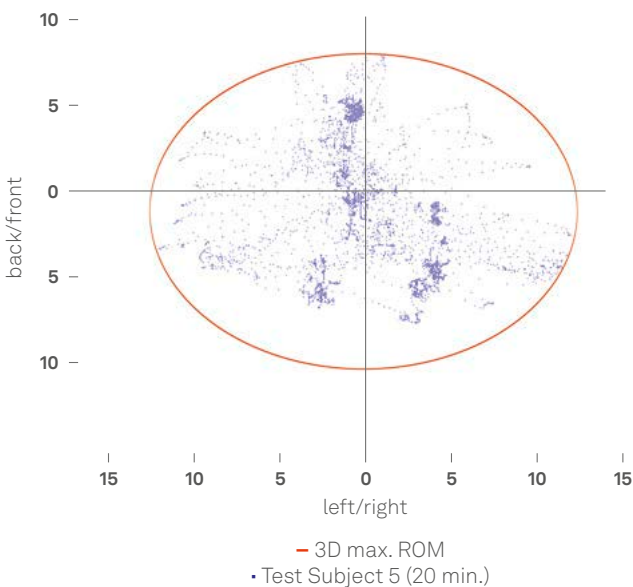

3D dynamic chair: distribution of movement frequency and maximum range of motion

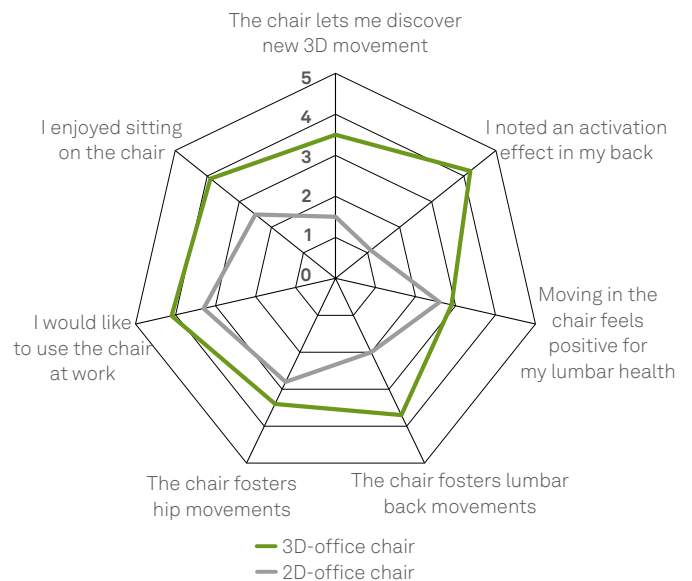

Spider chart of questionnaire results comparison sitting on the 3D- and 2D-office chair

Free to move: One principle – three solutions

The right free-to-move range for any requirements

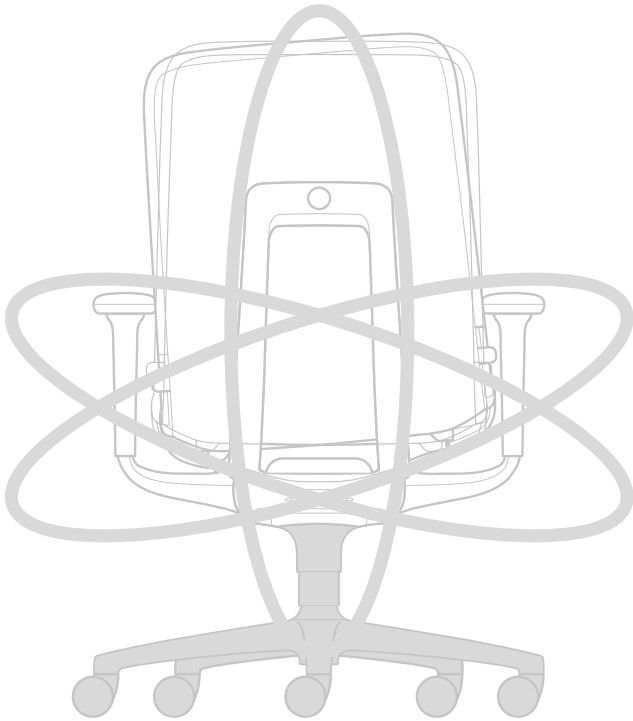

Sitting on 3D Free-to-move chairs feels exceptionally natural and pleasant, which is vital to fully benefiting from the advantages they offer. Nevertheless, there are differences in personal preferences and the demands placed by the various areas in which chairs are used. We've developed three Free-to-move office chair ranges so that people in all types of offices can experience Trimension®.

In the spacious, classically stylish **ON® office and conference chair** two swivel arms that can move independently of one another with their socket joints at hip height are driven by their own spring. With just one knob at the side, both springs and therefore the counter pressure in the seat and back can be adjusted in all directions to suit users' weights and comfort preferences. The clever part is that the counter pressure adapts synchronously to all changes of posture and movements.

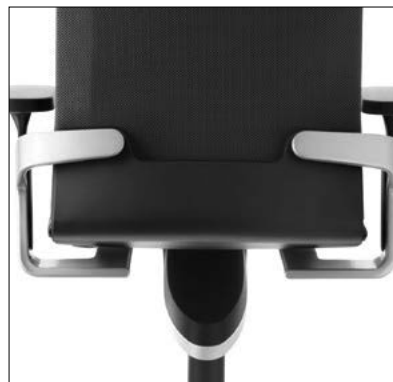

Trimension® with its two-part mechanism: when opened, the cover to the mechanism reveals the two springs that ensure multi-directional coordination of the counter pressure.

A direct control achieves the same effect in our compact, athletic and dynamic **IN office chair**. The two swivel arms also come with socket joints at hip height and move independently of one another. They're directly combined with an adjustable, flexibly mounted and enormously powerful central spring. As a result, shifts of weight are immediately translated into movements for exceptional dynamic movement that can be adjusted for people on the light or heavier side (45 – 140 kg).



Trimension® with direct control and central spring: the two swivel arms are part of the mechanism and (depending on the movement direction) press the springs together or move them to the sides.

In the case of the smart and scalable **AT all-rounder**, the seat and back are suspended in a self-centring manner and swivel-mounted on the flexible backrest bearer so that the body always maintains its centre of gravity. As a result, Trimension® can be combined with automatic weight adjustment that doesn't need to be adapted to the user. This is a real bonus in flexible office concepts or where hot desking is practised.



Trimension® with self-centring suspension and automatic weight adjustment: by combining the backrest bearer with its tilt function and the suspension of the shell with automatic adjustment, the body adapts accordingly whatever the movement and posture.

ON®

The classically elegant, broadly scalable office chair for front offices and conferences. Design: wiege

The launch of ON®, the first office chair with Trimension®, created a new benchmark in dynamic sitting worldwide. Thanks to its multi-award-winning quality design, variety of features and broad product family, it's the classic chair in the Free-to-move ranges destined above all for offices and conference rooms boasting high-quality with a touch of prestige.

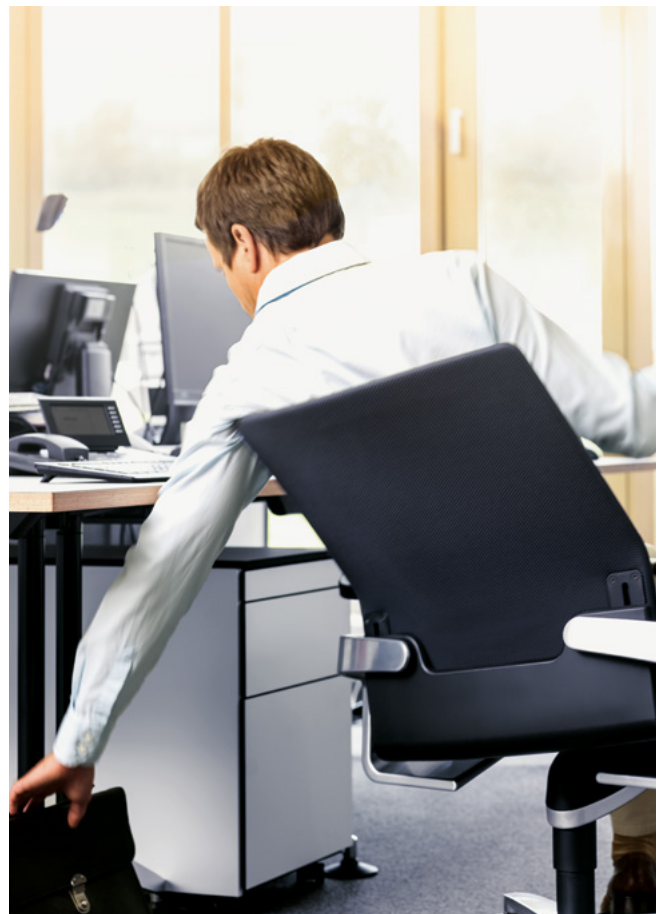

Not all awards/certificates/standards apply to all variants.



IN

The athletic and dynamic master of motion for people on both ends of the weight spectrum. Design: wiege.

IN's superior 3D capabilities are the result of a combination of direct control, highly flexible seat and back and cover in 3D Formstrick technologies that come from the cutting-edge automotive and sports footwear industries. The athletic look of the chair and variety of colours stands for an exceptionally dynamic and fresh corporate culture. IN is the ideal solution for anyone sitting at computers for long periods of time.



Not all awards/certificates/standards apply to all variants.



AT

The smart all-rounder with automatic weight adjustment. Design: Wilkhahn

Numerous basic models, automatic weight adjustment, a wide range of features and its pioneering design make AT the ideal Free-to-move office chair for hot desking offices and diverse settings in contemporary office environments. Three backrest heights, black and white frames and the backrest, optionally covered on the rear, offer lots of design options.



Not all awards/certificates/standards apply to all variants.



Sitting higher makes standing up easier

The free-to-move models with an elevated sitting position (ESP)

In addition to the office chairs' 3D range of motion, electrically height-adjustable desks are becoming the new standard in offices with a healthy workplace focus. The goal is to encourage people to alternate between sitting and standing. The problem is that most of us don't take up this option because getting up from a normal seating height and adjusting the table height are both too time consuming. Consequently, changing posture always means actively interrupting what we're doing.

And this is exactly where the free-to-move models with elevated sitting positions (ESP) come in. They can be used at normal desk heights as office chairs with full 3D ranges of motion but also be raised to a sitting height of more than 60 cm. The elevated sitting position also provides new additional features: if the seat is tilted forward,



AT task chair 187/72
Medium-height backrest
Elevated seating position (ESP)

ON® task chair 174/72
Medium-height backrest
Elevated seating position (ESP)

IN task chair 184/72
Medium-height backrest
Elevated seating position (ESP)

the office chair becomes a place to perch but where the backrest can be leant on at the same time. If people lean back, the tiniest shifts in weight suffice to stimulate the three-dimensional mobility of their pelvises and they can dangle their legs as well. On the other hand, the forward movement doesn't stop when people sit upright but almost automatically when they stand. Because the desk is slightly higher from the outset, it requires no or very little adjustment if users feel like standing up for a little while.



The impact is enormous because the desired change of posture between standing and sitting is intuitively incorporated into the body's movements and the workflow and carried out all the more often. As a result, the extra investment in height-adjustable desks truly pays dividends.

Free to move

A new benchmark in healthy sitting

Over the past few years, leading international experts have been putting the free-to-move chairs through their paces and declared them the new international benchmark in natural dynamic sitting. But above all, it's our over 500,000 enthusiastic customers and users who are the best ambassadors for our 3D sitting technology, which has yet to find its equal the world over.

“ON helps me stay comfortable all the time even if I have to sit all day at work. Three-dimensional movement makes me relax”.

Masami Shibasaki, Senior Project Designer, Interior Design, NIHON SEKKEI, INC., Tokyo, Japan

“Even after sitting on the chair for many years, it still surprises me that it stimulates me to move. And each movement's refreshing, keeps me fit and alert. These spurts of movement on the chair are relaxing and help me to be imaginative, which is vital to creativity.”

Dieter Boch, psychologist and managing partner of the Institute for Occupational Research and Organisational Support, Sonthofen, Germany.



“The chair was right for me from the word go. Moving so far backwards and sideways on a chair is a totally new experience and gives you the feeling that you can move freely with the chair supporting you at the same time.”

Professor Martin Schmauder, ergonomist at the Institute of Material Handling and Industrial Engineering, Technical University Dresden, Germany

“The IN chair is a favourite within our studio. When I'm not in, it seems to attach itself to other people's desks. The key change I have noticed after 12 months of sitting, is the continual adjustment across the day. I sit backwards and move side to side when on the phone or in a Skype meeting, and then forward and upright when drawing or on the computer. The mechanisms allow for easy side-to-side motion to help me collaborate with team members. Now I'm used to IN – I can't go back.”

Tanya Hillman, Design Leader, Geyer, Melbourne, Australia



“After a year of sitting on Wilkhahn’s IN, my backache and slipped disc have magically gone. Sitting on IN feels a bit like an involuntary keep-fit session – it’s very pleasant and clearly very effective.”

Martin Haller, Caramel Architects,
Vienna, Austria

“I suffered from back pain for a long time because I have to sit on a chair in my office all day. ON allows my body to adopt various postures and it’s much more comfortable. I also feel more creative whenever I sit on ON”.

Masaki Kasuya, Designer, The Design Studio K.K., Tokyo, Japan

“When we consolidated our offices into one location we had to select one chair for everyone. Hands down the winner was the ON chair. This will be our standard going forward for all locations.”

Patrick Dovigi, CEO, GFL Environmental, Toronto, Canada



“The new AT office chair allowed us to enter new territory in terms of sitting-standing options because the whole sitting experience is completely different. However, there has always been a certain amount of scepticism about change. But after a brief familiarisation period, nobody wants to have their old office chair or workspace back.”

Fred-Martin Dillenberger, head of corporate real estate management,
SMA Solar Technology, Kassel, Germany.

Free-to-move chairs in today's offices

SMA Solar Technology AG's Future Office

The SMA Group, headquartered in Kassel, Germany, is a leading global specialist in photovoltaic inverters with a broad portfolio of solutions for solar roof installations, commercial solar systems and large solar power plants. Thanks to intelligent energy management solutions, SMA creates the conditions for local, digital and renewable energy in tomorrow's world.

The purpose of its Future Office pilot project was to optimise office space management on the one hand and boost the agility, innovativeness and fitness of the workforce on the other. The digital transformation is something virtually all industries are now having to get to grips with.

Which is why the Future Office concept offers people different workspaces to suit the task at hand. A common denominator of all the areas is that they are designed to foster team spirit and collaboration and encourage physical activity, engagement and a change of posture.

The multipurpose, collaborative space features Stitz sitting-standing stools and is somewhere where people arrive, meet up, interact and eat and drink with one another, a place for them to enjoy themselves and relax.

The Home Base is furnished exclusively with height-adjustable desks and ESP models of the AT free-to-move chair with automatic weight adjustment. These automatically ensure that people of all shapes and sizes move more while sitting and alternate between sitting and standing.

The Future Office has now established itself as a style of working that both businesses and employees grappling with the digital transformation benefit from.

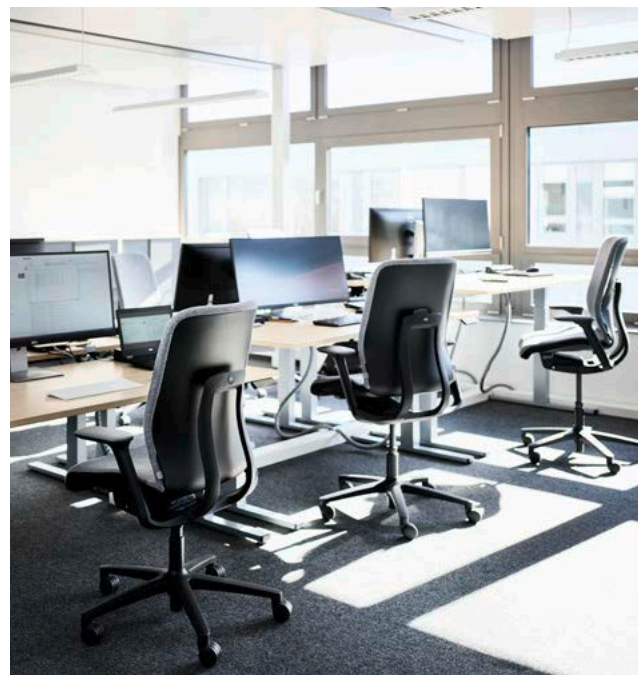



In the Innovations Box, mobile, folding Timetable options and stackable Aline chairs support agile styles of collaboration in workshops and project spaces ...



... with sofas and Stand-ups, the Feedback Box is the ideal place to talk to other people as equals ...



... and the Silence Box is for anyone needing peace.



A Quick Decision Box with its Stitz sitting-standing stools, Sitzbock pommel horse seats and Landing wall relief prompts casual interaction and an important change of perspective. ...



... and the Stand-up stools foster frequent activity-driven breaks.

Free to move: desk-based movement spreads to embrace whole workspaces

Temporary standing instead of constant sitting

But more motion isn't merely required for deskwork. The huge number of meetings held sitting down also often leads to a comatose lack of movement. But some of these meetings could be carried out at high tables. The Stitz sitting-standing stool combines movement with partial relaxation and avoids overtaxing muscles. A welcome side effect is that the meeting's quicker, people get more involved and better circulation to the brain makes it more productive.

As a classic piece of sitting-standing furniture, the legendary Stitz 2 (design: PER) is equally as contemporary today as it was just under 30 years ago.

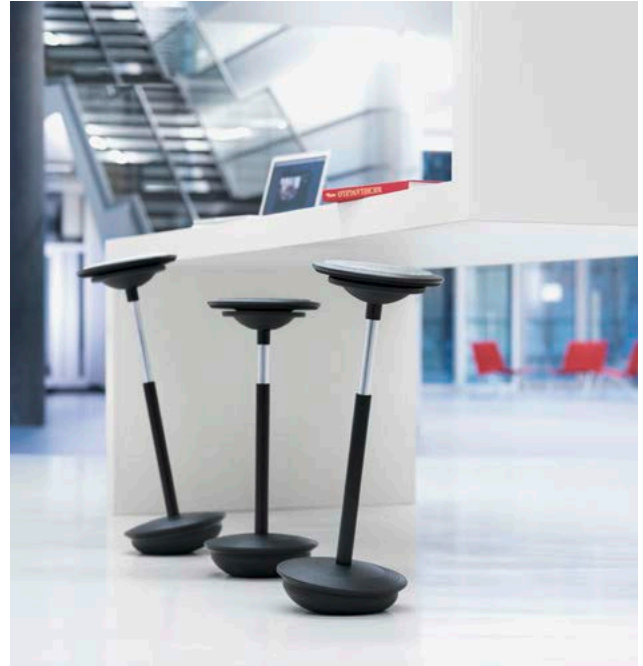

Using breaks for exercise

New research results show that recuperation is only possible if hard work is interspersed by periods of relaxation too. In digital styles of working, the way breaks are designed with physical relaxation and lots of communication continues the lack of movement in front of a screen, but mentally we don't get any breaks. On the other hand, objects like the Stand-up allow us to swing our hips and be more focused in order to maintain equilibrium, which is healthy for both body and mind.

Stand-up (design: Thorsten Franck) is a colourful eye-catcher and its flexible nature helps keep body and mind happy.



Providing stimuli and encouraging active participation

Mental and physical stimuli can be combined in workshops, seminars and project meetings if these environments are designed to inspire people to help organise them too. The mobile, swivel-mounted or foldable tables in the Confair and Timetable ranges allow attendees to adapt the setting to the event concerned. This type of participation is very helpful especially in the case of change projects. After all, group dynamics has a lot to do with the dynamics of motion.

Pop-up conferencing in flexible space concepts: the Confair folding table (design: Andreas Störiko) allows spaces to be turned spontaneously into project conferences.

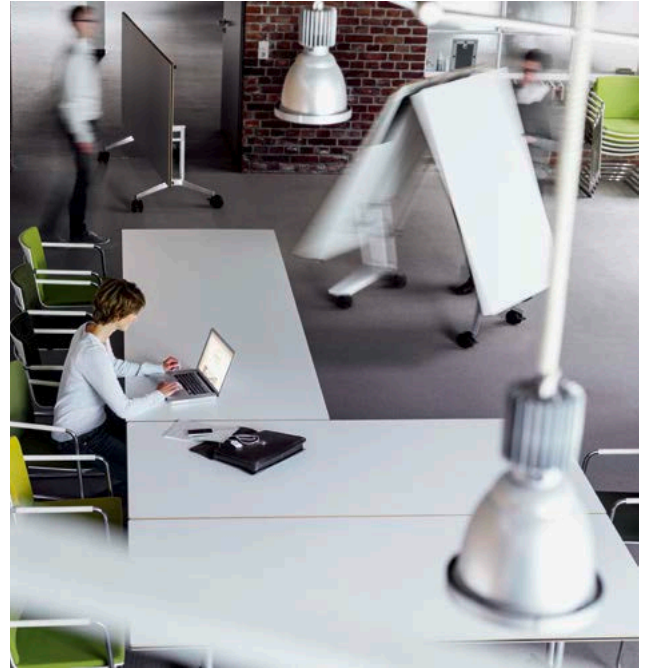

Carpe momentum

Seize the moment. Examples of this approach are the Landing wall relief, which allows people to stop and chat to one another in busy corners where space is at a premium. Or the Sitzbock pommel horse seat, which inspires teams to develop new ideas while casually changing posture in chill-out spaces, kitchenettes or on patios.

The Landing wall relief (design: RSW) is somewhere for people to lean on and use as a table or shelf while the Sitzbock pommel horse seats (design: RSW) and their “saddle blankets” awaken memories of childhood.



Service

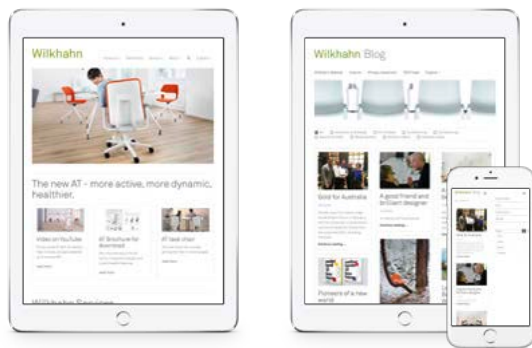
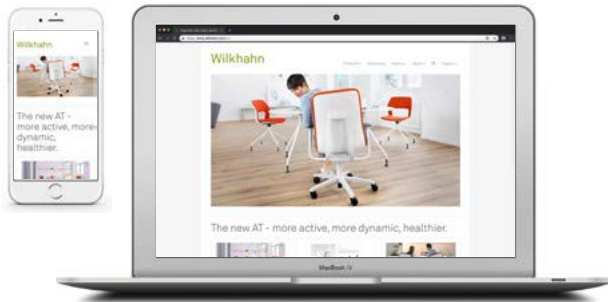

The website's new structure and design provide easy and clear access to Wilkhahn's products, projects and services. You'll be able to find everything you need there – from the digital brochure to CAD data and reference images.

Why not read our blog to find out all the exciting things happening at Wilkhahn in the world of design, architecture and industry?

Our online product literature and digital brochures contain more in-depth information.



About this publication

Creative direction

Rainer Schilling

Design

scherrer.

Author

Burkhard Remmers

Photography

Thomas Bach, Hanover (pages 16, 18 – 21, 28, 29)

Henning Bode, Hamburg (page 2)

Interior design by Axel Frey, Munich, photography by Rainer Hofmann, Munich (page 17)

Frank Schinski (pages 22 – 27, 29)

Project management and production

scherrer.

Languages

German, English

© 2019 Wilkhahn

Wilkening + Hahne GmbH+Co. KG

Fritz-Hahne-Straße 8

31848 Bad Münder

Germany

Wilkhahn Germany

Wilkening + Hahne GmbH+Co. KG, Fritz-Hahne-Straße 8, 31848 Bad Münden

Wilkhahn worldwide

Australia, Belgium, China, Deutschland, España, France, Hong Kong, Japan, Maroc,
Nederland, Österreich, Polska, Schweiz, Singapore, South Africa, United Arab Emirates,
United Kingdom, United States of America

wilkhahn.com