

PACKER BRUSH

For the ASHFORD DRUM CARDER - Fine or Coarse

It helps -

- pack the carded fibres into the teeth of the large drum which allows more fibres to be carded and results in a thicker batt.
- It helps control fine low crimp fibres such as mohair, angora and alpaca.

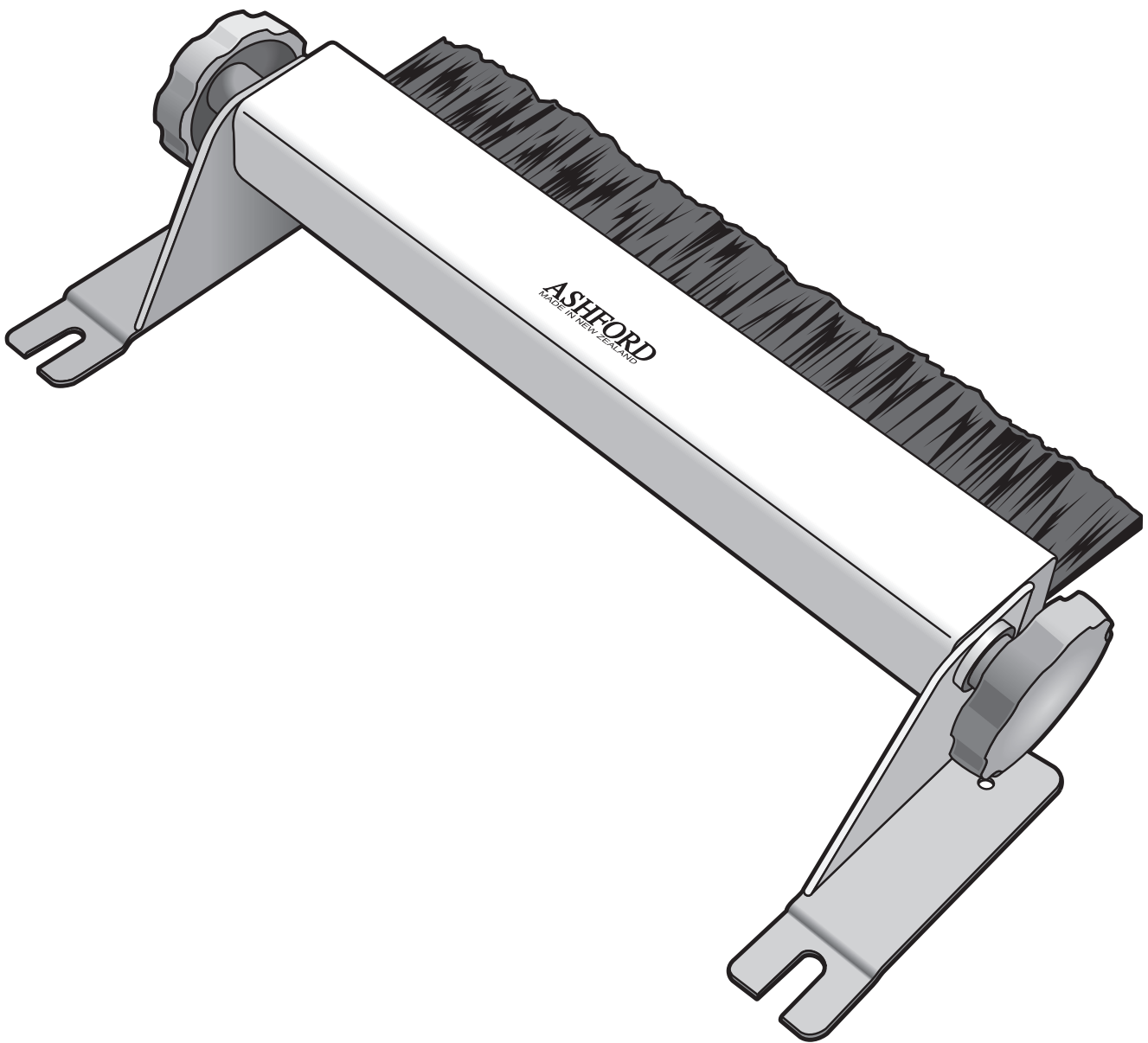

ADCPB09022012V3

ASSEMBLY

1. Remove the drive belt.
2. Using the spanner supplied and loosen both top bolts about 3 turns.

IMPORTANT: Avoid loosening the bolts any more than necessary; otherwise the nut on the end of the bolt may come off.

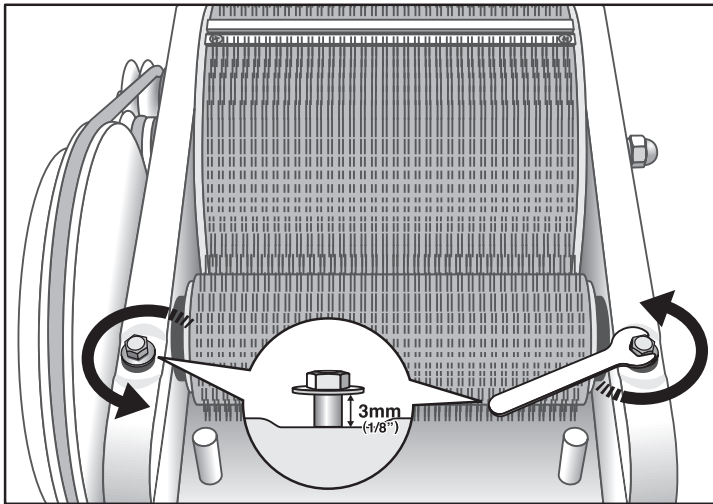

3. Lift the washers under the head of the bolt and slide the brackets into place under the washer.
Note: the brackets are either left or right.
4. Attach a washer and knob on both ends of the packer brush. Place the packer brush with the washers to the outside into the slots in the brackets.

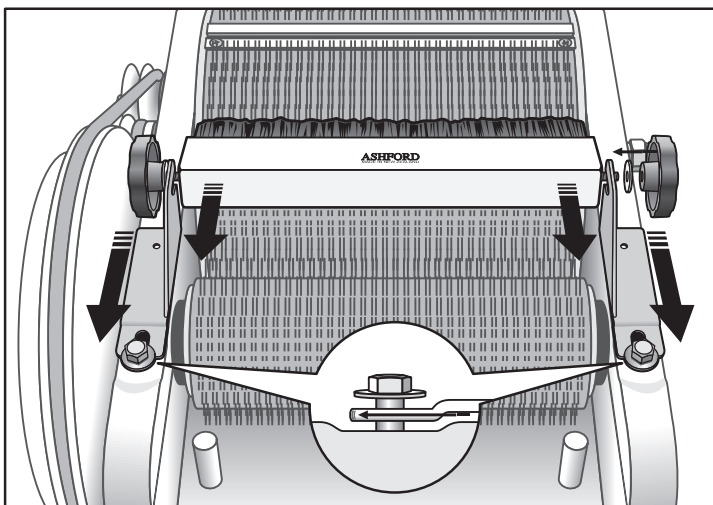

5. Rotate the packer brush until the bristles are about 1/2 way into the carder teeth, then tighten the 2 knobs.

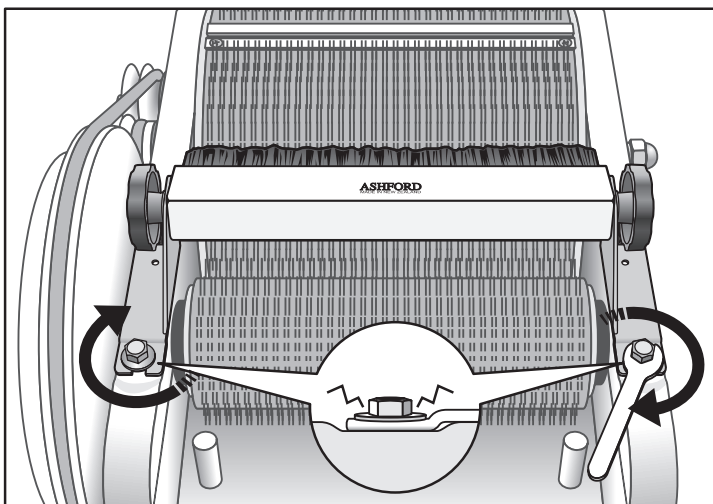

6. Check the brackets are evenly positioned under the bolt heads and the gap between the carder teeth is between 0 and 1.0mm / 0 – 3/64". Then retighten both bolts firmly.
7. Place the drive belt back around the pulleys.

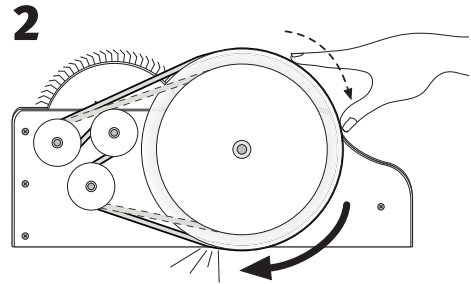
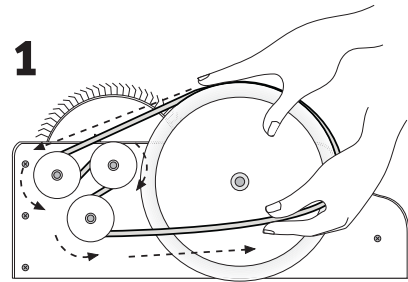

You are now ready to start carding.

When the large drum is full or fibre starts collecting on the small drum, loosen the 2 knobs and twist the packer brush up out of the teeth.

Remove the batt, clean the drums as necessary, reposition the brush into the carder teeth and tighten the 2 locking knobs.

Experiment with the position of the brush to best suit the fibre you are carding.

Hint: Place your fibres on the feed-in tray, turn the handle and let them feed in. Don't hold onto your fibres, otherwise they will collect on the small drum.

Happy Carding!