



100/105 SERIES

Toyota



Installation Instructions



LC100/105 Emuwing Installation Instructions

Due to the intrusion of the hinge this product is not suitable for vehicles with passengers in the seats adjacent to the Emuwing. The Emuwing is designed as an addition to a storage system and should be removed if the seats adjacent to the Emuwing are ever reinstated.

Parts List

 <p>Frame 1 per side</p>	 <p>Wing Panel x 1 per side</p>	 <p>Glue and Nozzle x 1 per kit</p>
 <p>Support Brackets x 2 per side</p>	 <p>Hinge & Faceplate – One front & One rear per side (Pre-Assembled)</p>	 <p>Weather Seal, 1 per side cut to length</p>
 <p>Gas Struts – two per side</p>	 <p>Panhead bolts x 4 per side</p>	 <p>Emuwing Flyer x 1 per kit</p>
 <p>M4 Nyloc Nut x 8 per side</p>	 <p>M4 Nyloc Washer x 8 per side</p>	 <p>M4 Hex Bolts x 8 per side</p>
 <p>Chalk Pen x 1 per kit</p>	 <p>Keyring x 1 per kit Keys x 2 per side</p>	 <p>Installation Instructions</p>  <p>Model specific installation instructions x 1 per kit</p>

Other items and Tools Required:

- Allen Key 3mm
- Medium size Phillips's head screwdriver
- Eight to Twelve Clamps per side
- Spanners and or sockets (7mm, 8mm, 10mm, *27mm)
- Caulking/Glue gun
- Wax and Grease remover or other solvent that leaves no residue
- Clean rags or kitchen paper
- Masking tape
- Heat Gun

*Glass models only

LC100/105 Emuwing Installation Instructions

Due to the intrusion of the hinge this product is not suitable for vehicles with passengers in the seats adjacent to the Emuwing. The Emuwing is designed as an addition to a storage system and should be removed if the seats adjacent to the Emuwing are ever reinstated.

Contents

Parts List.....	0
1: Remove the existing rear window and mark the interior trim for cutting.	3
- Remove interior trim, glass and rubber.....	3
- Marking interior trim for cutting.	3
2: Installing the frame.	4
- Positioning the frame.	4
- Gluing the frame into place.	4
- Cutting interior trims.	5
3: Attaching the door panel.	6
- Place and tighten the support brackets.....	6
- Attach the hinges.....	6
- Placing the door panel.....	6
- Securing the door panel.....	6
- Attach the gas struts.....	7
4: Adjusting the door panel depth and fitting the weather-strip.....	7
- Adjustments – left/right and up and down.	7
- Applying the weather-strip.....	7
- Primer	7
- Adjustments – Depth.....	8
- Setting the weather seal.....	8
- Plastic Grommets.....	8
5: Glass supplement.	9

The following instructions detail the installation of your new EmuWing kit; allow a total of two to three hours fitting time for each panel excluding curing time. Read the instructions thoroughly before starting. Allow any additional time that may be required for rust repairs. We have installations on our YouTube channel which may be worth watching before commencing.

LC100/105 Emuwing Installation Instructions

Due to the intrusion of the hinge this product is not suitable for vehicles with passengers in the seats adjacent to the Emuwing. The Emuwing is designed as an addition to a storage system and should be removed if the seats adjacent to the Emuwing are ever reinstated.

1: Remove the existing rear window and mark the interior trim for cutting.

- Remove interior trim, glass and rubber.

Remove the existing rear window rubber and the interior trim.

The interior trim requires the removal of both second-row top seat belt mounts, the rear most grab handles and the plastic plugs placed underneath the trim running across the top of the rear cargo doors.

As the lower trim also needs to be pulled back to allow the upper trim to be removed, drawer systems may make this difficult, as will cargo barriers etc... and may need to be removed.

Once the upper interior trim has been removed there are two bolts to remove - a long 10mm socket is ideal to get the recessed front nuts. Take great care removing these nuts at the front – if the nuts are dropped, retrieval may be all but impossible and a permanent rattle may remain. After removing the rear window and rubber, wash off any dirt or residual glue from around the seam.

- Marking interior trim for cutting.

Reinstall the interior trim temporarily, once it is in its original position it will overhang the outside of the car. The frame of the Emuwing will sit flush against the body so any excess material needs to be marked and removed.

Before removing the interior trim, you can also mark the top support bracket (Figure 1) as this requires an additional 5mm of material to be removed. Place the frame against the car and mark the position of the top supports of the frame onto the plastic interior trim.

Once the trim has been marked up it can be removed allowing you to move onto installing the frame.

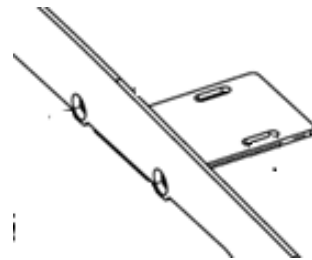

Support bracket on frame. Figure 1.

LC100/105 Emuwing Installation Instructions

Due to the intrusion of the hinge this product is not suitable for vehicles with passengers in the seats adjacent to the Emuwing. The Emuwing is designed as an addition to a storage system and should be removed if the seats adjacent to the Emuwing are ever reinstated.

2: Installing the frame.

- Positioning the frame.

Make sure you understand the positioning of the frame before attempting to glue it into position. Although there is some adjustment in the panel later during installation – correct positioning of the frame will ensure a smooth installation and a great finish.

Without applying glue, position the frame.
Leave approximately a 3mm gap underneath.
(Figure 2).

Move it back into position until the rear corner is as far back as it will go whilst remaining flat against the car.

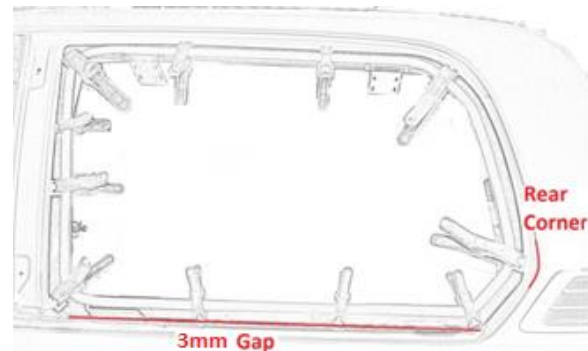

Figure 2.

At this point place a clamp on each corner of the frame, the frame will easily mould to the car. It is a good idea to apply some masking tape around the frame, this will help with glue clean up later in the process.

- Gluing the frame into place.

Remove the frame and clean the back and around the window seam ensuring no residual is left on either surface. Wearing gloves will ensure no grease or oils from your hands contaminate the surfaces.

Remove the nuts and washers from the top of the frame and put aside.

Apply an even consistent bead of Sikaflex around the inside edge of the window seam on the car – approximately 5mm wide, increasing the bead slightly to 6/7mm around the corners.

There is plenty of glue in your kit for a practice run before putting glue on the window seam.

Make sure there are no gaps in the bead, and it is consistent around the window.

Make sure your clamps are close to hand before placing the frame.

Place the frame into position and place clamps firstly onto each corner, then along the top and bottom edges.

We recommend looking closely to ensure no light can be seen between the frame and car. Use more clamps if required, a torch may help.

Once the glue is applied and the frame is in place, leave to dry for at least 24 hours.

Whilst the glue is wet and the frame is clamped, carefully clean up any excess glue from around the frame.

Use an old rag to push the excess glue onto the masking tape, once all the glue has been pushed back – remove the masking tape, carefully ensuring the glue remains on the tape and not all over you and the car.

The glue can be cleaned up using wax and grease remover whilst wet, do not leave it to dry or it will be difficult to remove without damage to the paintwork.

LC100/105 Emuwing Installation Instructions

Due to the intrusion of the hinge this product is not suitable for vehicles with passengers in the seats adjacent to the Emuwing. The Emuwing is designed as an addition to a storage system and should be removed if the seats adjacent to the Emuwing are ever reinstated.

Do Not proceed with fitting any hardware to the frame until the glue has set and the frame is securely in place (at least 24 hours). Figure 3.

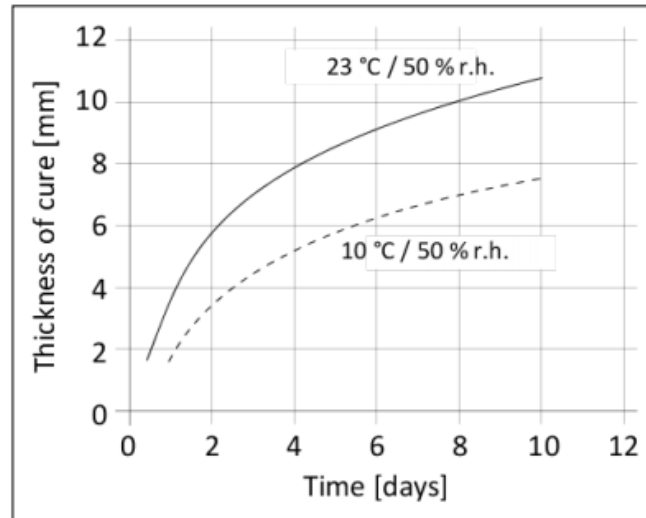

Figure 3.

- Cutting interior trims.

The interior trim can be cut in preparation for reinstallation. There is a guide on our YouTube channel worth looking at if you are not sure about these cuts. Carefully cut along the marks you made on the interior trim removing between 2mm to 5mm of material. An additional 5mm will need to be removed at two sections at the top of the panel, where the Support brackets attach to the frame. (Figure 4).



Figure 4.

LC100/105 Emuwing Installation Instructions

Due to the intrusion of the hinge this product is not suitable for vehicles with passengers in the seats adjacent to the Emuwing. The Emuwing is designed as an addition to a storage system and should be removed if the seats adjacent to the Emuwing are ever reinstated.

3: Attaching the door panel.

- Place and tighten the support brackets.

Assemble the support brackets on top of the frame; using the previously removed nuts and bolts to clamp the frame to the body. Do not over tighten these bolts, just tighten them firmly.

(Figure 5).

Ensure the two bolts are evenly tightened so the slots in the two brackets align and the bracket is firmly against the body.

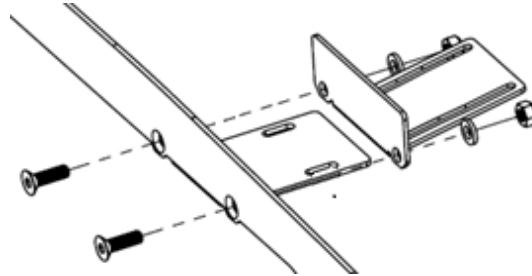

Figure 5.

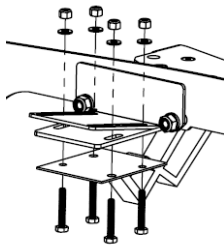

Figure 6.

- Attach the hinges.

Attach the Hinges to the frame using the supplied 4mm nuts, bolts, and washers so the face plate protrudes around 8mm from the frame. The exact depth will be adjusted later. (Figure 6).

- Placing the door panel.

When the hinges are in the closed position, place the door panel centrally. We suggest using a spacer at the bottom of the door panel to lift it up slightly so that the panel is aligned correctly. Close the rear passenger doors to help with alignment. (Figure 7).

Note: when the gas struts are attached the door panel will be pushed up as the hinges compress – try to allow for this when placing the door by positioning the panel 1 or 2 mm lower than it needs to be.

Close the handles a little so the cam latches over the frame to secure the panel in place while fixing into position.

- Securing the door panel.

Placing the Pan Head bolts with rubber washer from the outside; place a washer and nut on the inside.

Once all four pan heads are in place and secure, check that the door does not foul the car when opening and closing. If there is any fouling, adjust the door accordingly before attaching the gas struts.

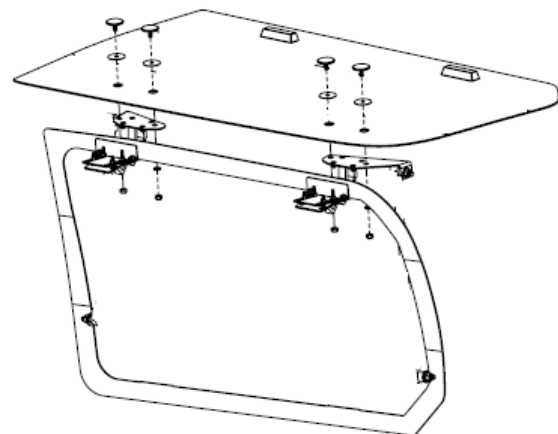

Figure 7.

LC100/105 Emuwing Installation Instructions

Due to the intrusion of the hinge this product is not suitable for vehicles with passengers in the seats adjacent to the Emuwing. The Emuwing is designed as an addition to a storage system and should be removed if the seats adjacent to the Emuwing are ever reinstated.

Before loosening any nuts for any further adjustments, **detach the gas struts first** to prevent the hinges from twisting.

- Attach the gas struts.

Once the Door panel is adjusted as much as possible, open the door and attach the struts (*wider end to the top*). Close the panel carefully, again watching if it touches the car as it closes. Once closed, note any required adjustments to the door panel to align it with the car.

The depth of the door can be adjusted later, once the seal has been attached. At this stage we are only concerned with the position of the panel in relation to the car, however, if your panel sits out from the frame more than 10mm it may be worth adjusting this in to at least 10mm.

4: Adjusting the door panel depth and fitting the weather-strip.

- Adjustments – left/right and up and down.

The door panel can be adjusted up/down and left/right by loosening the pan heads that attach the door to the hinge. Make note of the required adjustments and mark the current position of the hinge plate on the inside of the door before removing the struts and loosening the pan heads. Once you are happy the door panel is adjusted into position and the gas struts are reinstalled, the weather seal can be attached to the inside.

- Applying the weather-strip.

Close the door panel and carefully mark inside the door panel around the inside edge of the frame noting the distance between the line and the edge of your frame.

- Primer

Before attaching the weather strip use the supplied 3M primer where you will be applying the weather strip. Apply using long strokes exactly where the weather strip will be placed

Once the door has been marked and primed, the weather seal can be attached to the door following outside of the marked lines so the seal will line up on the frame (if the seal does not correctly align, moisture and dust will find its way into the back of the vehicle). (Figure 8).



Figure 8



Do not stretch the weather strip, especially around the corners – just allow it to place onto the panel. Otherwise, you may find it will shrink with heating and peel from the panel.

LC100/105 Emuwing Installation Instructions

Due to the intrusion of the hinge this product is not suitable for vehicles with passengers in the seats adjacent to the Emuwing. The Emuwing is designed as an addition to a storage system and should be removed if the seats adjacent to the Emuwing are ever reinstated.

- Adjustments – Depth.

Once the weather seal has been set in place, close the door panel and check the depth to ensure it aligns with the car and compresses the rubber seal. If adjustment are required, loosen the hinges from the top supports (the gas struts do not need to be removed), apply pressure evenly to the outside of the door where the hinge meets the door until you see the rubber compress onto the frame, and then re-tighten the bolts.

- Setting the weather seal.

Close the Emuwing and leave the car in the sun for a few hours to activate the glue on the back of the weather seal – leave the wing closed for around 24 hours while the glue on the weather seal sets. The panel needs to get hot to the touch to activate the glue on the rubber and ensure long term adhesion. A heat gun may assist in cooler weather.

- Plastic Grommets.

You will find some black plastic grommets in the kit; these are used to fill the holes left by the bolts that held the original window in place.

The interior panel may require some additional trimming around the support brackets at the top of the frame, as well as at the bottom to allow the door handle cams to close.

Place the interior panel into position and mark where it will need to be cut and check clearances before putting everything back together.

If additional help is required, please feel free to give us a call on +613 8592 1926 between the hours of 10am and 4pm AEST – Monday to Friday.

LC100/105 Emuwing Installation Instructions

Due to the intrusion of the hinge this product is not suitable for vehicles with passengers in the seats adjacent to the Emuwing. The Emuwing is designed as an addition to a storage system and should be removed if the seats adjacent to the Emuwing are ever reinstated.

5: Glass supplement.

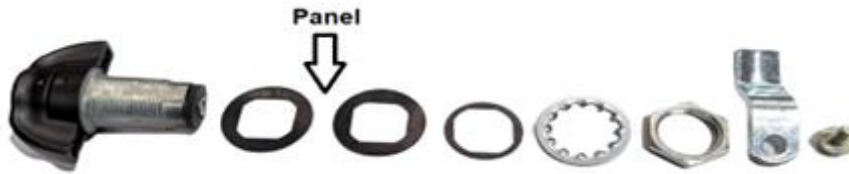

We recommend tinting the glass prior to installation, this ensures the weather strip will not deteriorate faster than usual due to UV exposure.

Instructions:

1. Ensure glass is tinted and dry before attempting assembly.
2. Disassemble handles noting the order of reassembly, the panel is located between the two rubbers when reassembling.
3. Tighten the barrel nut until the rubbers are compressed ensuring a good seal.
4. Assemble and insert handles.
5. Ensure thread locking compound is used on the 10mm bolt securing the cam latch.

Prior to installation of the Emuwing kit the handles should be reassembled into the glass panel.

Ensure thread locking compound is used on the threads of the 10mm bolt securing the Cam.

Website: emuwing.com.au

Phone: +61 3 9017 1614

Email: info@emuwing.com.au



For Distributor and Installer enquiries please email sales@emuwing.com.au

9/146 Northbourne Road
Campbellfield
Victoria, 3061

ABN: 84 617 251 733