



TORI MURPHY

WOVEN & MADE IN ENGLAND

Made For Me
Curtains &
Roman Blinds

MADE FOR ME MEASURING GUIDE 2022

WWW.TORIMURPHY.COM



About Us

Tori Murphy celebrates its 10 year anniversary with the launch of 'Made for Me', an online made-to-measure curtain and blind service. Established in 2012, Tori Murphy is an English textile brand dedicated to creating thoughtful, timeless products for the modern family home. Rooted in designer/founder Tori's contemporary approach to pattern and commitment to English craftsmanship, fabric is woven in Lancashire, washed in the Yorkshire Dales, and made in to product in Nottingham. Pared back, elegant, endlessly versatile and eminently livable-with, Tori Murphy is the essence of relaxed English style, comfort and tradition.

Over the years, as the brand's reputation grew, so too did the requests for the window treatments.

"I also found myself with a full house renovation underway and many windows to dress. I didn't know where to find curtains that suited my style, or how to confidently measure and order. I wanted them made in England not off the shelf, and I knew others felt the same," Tori was steadfast in her commitment to English manufacturing. **"With the support of a local, carefully chosen factory, I'm now able to offer beautiful made-in-England curtains and blinds made just for you,"** she finishes. Whether looking for a simple roman blind, or a luxurious gathered and insulating ceiling-to-floor flop-over frill door curtain, choosing window treatments can be a daunting process. 'Made for Me' is designed to hold your hand every step of the way.

Here To Help

email: madeforme@torimurphy.com or call: 01158 241 305



Our *Made For Me* Service

Choose from our edited selection of Tori Murphy fabrics for a 10-14 days service. Call us for bespoke projects with access to the full collection. Ordering online is simple, with straightforward measuring guides or in-house estimators who can talk you through your requirements via telephone or video call.



Made to measure consists of:

- Curtains and roman blinds made to your size and specification.
- A choice of linings.
- A choice of curtain heading styles including:
3" Pencil Pleat, 6" Pencil Pleat
Double Pinch Pleat, Triple Pinch Pleat
Cottage Pleat
Flop Over Frill

How to place an order?

- Measure for your curtains or roman blinds using the measuring guide found on page 6-8.
- Select your Tori Murphy Fabric.
- Pick a header if buying curtains or choose a chain colour if buying roman blinds.
- Choose from a selection of linings including smart double sided Tori Murphy fabric options.



How To Measure For Pinch Pleat & Pencil Pleat Curtains

Measuring the width

Already have a pole or track?

Measure the width of the pole between any decorative finials or end caps OR the width of your track.

No pole or track in place?

Measure the width of the window reveal, then add to this how far you would like your curtains to run past each side of the window reveal.

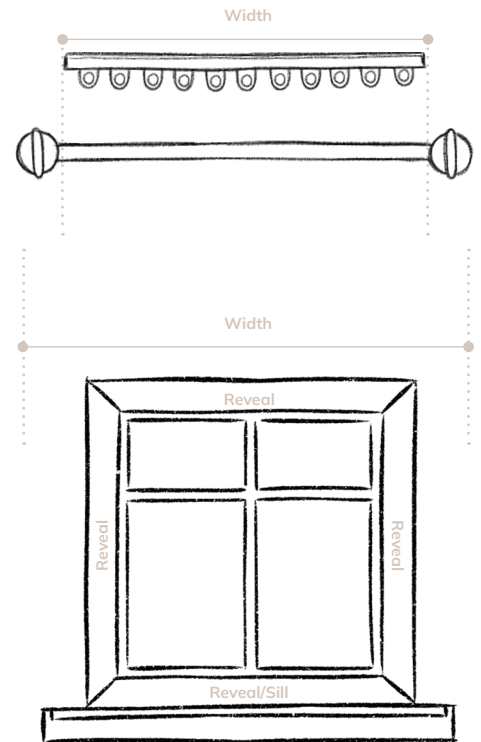

6

Measuring the drop (length)

What length of curtain will suit your windows? Do you want them to finish at the sill, below the sill or fall to the floor?

If you are using a curtain track:

To the sill: Measure from the top of the track to 1cm above the sill.

Below the sill: Measure from the top of the track to the required length below the sill (usually 15 - 20cm). If you have a radiator below your sill, measure to 3cm above the radiator.

To the floor: Measure from the top of the track to 1.5cm above the floor. This prevents the curtain dragging on the floor or becoming soiled or damaged.

If you want your curtains to drape on to the floor, add to this measurement how far you would like your curtains to drape.

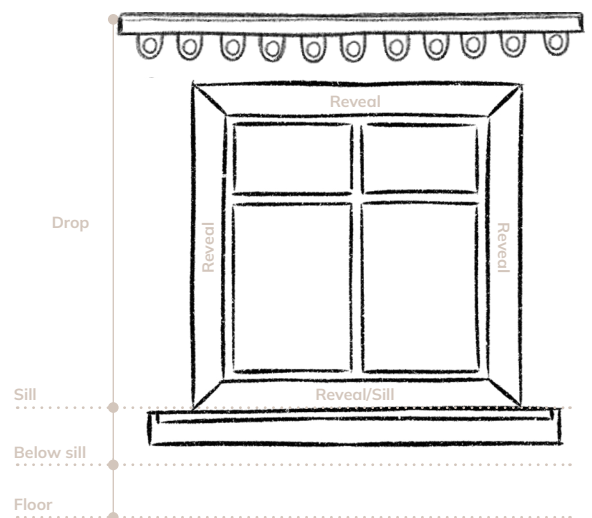

*What is a window reveal? A window reveal is the area surrounding a window which creates the opening in the wall, usually with a timber window sill at its base. A measurement for height (drop) would be taken between the top surface of the sill to the underside of the top (horizontal) surface. A measurement for width would be taken between the left and right hand side of the vertical surfaces.

If you are using a curtain pole:

To the sill: Measure from the underside of the pole ring to 1cm above the sill.

Below the sill: Measure from the underside of the pole ring to the required length below the sill (usually 15 - 20cm). If you have a radiator below your sill, measure to 3cm above the radiator.

To the floor: Measure from the underside of the pole ring to 1.5cm above the floor. This prevents the curtain dragging on the floor or becoming soiled or damaged.

If you want your curtains to drape on to the floor, add to this measurement how far you would like your curtains to drape.

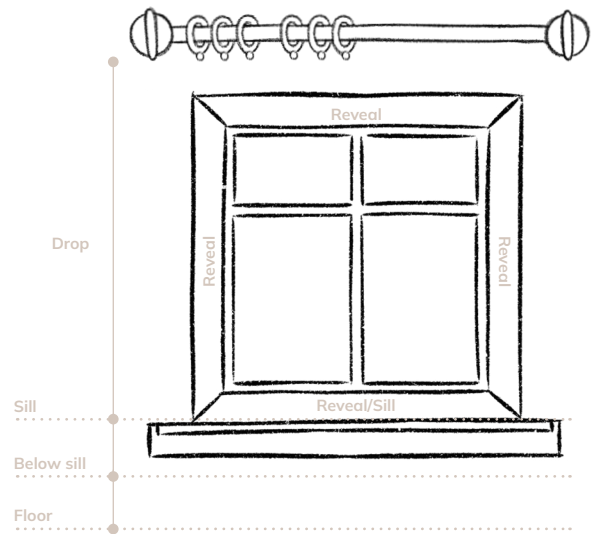
**How To Measure for Cottage Pleat**

Measure as you would for Pinch or Pencil Pleat and then choose if you would like the gathered pleat to stand 5cm or 10cm above the curtain ring eyelet.

How To Measure for Flop Over Frill

Measure as you would for Pinch or Pencil Pleat and then choose the depth of the flop over frill. You can order up to 30cm deep online, for anything deeper please get in touch madeforme@torimurphy.com

7
|

***What is a window reveal?** A window reveal is the area surrounding a window which creates the opening in the wall, usually with a timber window sill at its base. A measurement for height (drop) would be taken between the top surface of the sill to the underside of the top (horizontal) surface. A measurement for width would be taken between the left and right hand side of the vertical surfaces.

How To Measure Roman Blinds

Measuring the width

Decide whether or not you want your blind to fit inside the window reveal or outside the window reveal.

Outside the window reveal:

Measure the width of the window reveal and add to this how far you would like your blind to run past each side of the window reveal. To minimise light leakage we recommend that the blind overlaps the window recess by a minimum of 7cm at the top of 5cm at each side.

Inside the window reveal:

Measure the width of the window reveal at the top, centre and bottom. Take the smallest measurement. We will adjust from this measurement to ensure the blinds do not catch the side of the reveal when raised or lowered.

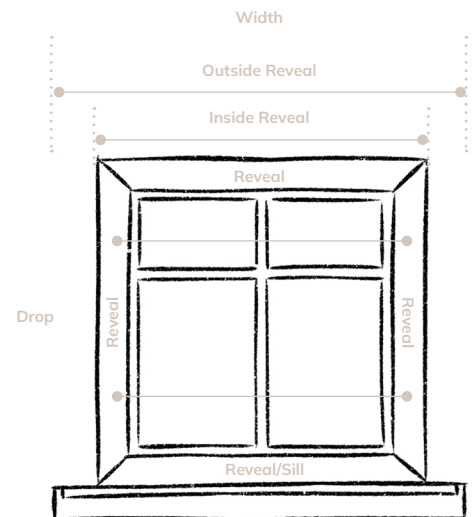

8

Measuring the drop (length)

Outside the window reveal:

Measure from the top of where you would like the blind to be to your desired length. The overlap at the bottom of the blind is personal choice but remember to take account of the obstacles such as radiators.

Inside the window reveal:

Measure the height of the window reveal at the left hand side, centre and right hand side and give the smallest measurements.

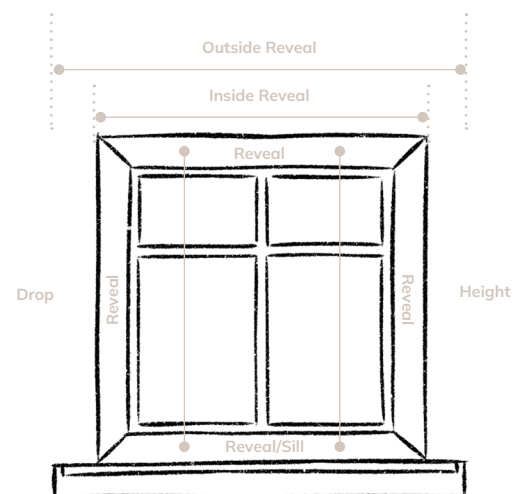

*What is a window reveal? A window reveal is the area surrounding a window which creates the opening in the wall, usually with a timber window sill at its base. A measurement for height (drop) would be taken between the top surface of the sill to the underside of the top (horizontal) surface. A measurement for width would be taken between the left and right hand side of the vertical surfaces.



Curtain Headers

There are a number of header styles to choose from, including pencil pleat tape, pinch pleat, Cottage Pleat or Flop Over Frill. All of our curtains come fully lined as standard with sateen twill, or you can upgrade to one of our performance linings, such as blackout or thermal.

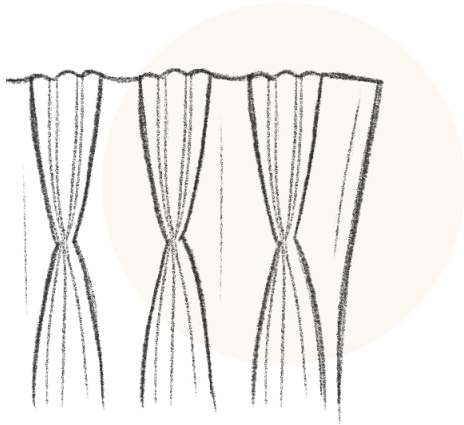

— Pinch Pleat Triple

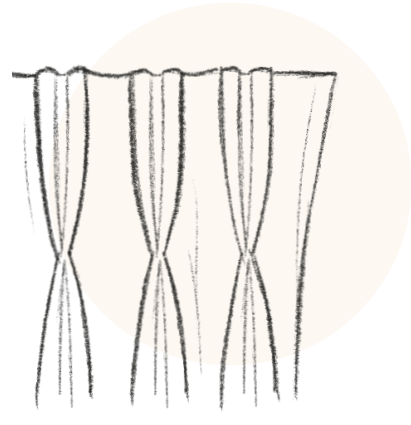

— Pinch Pleat Double

10

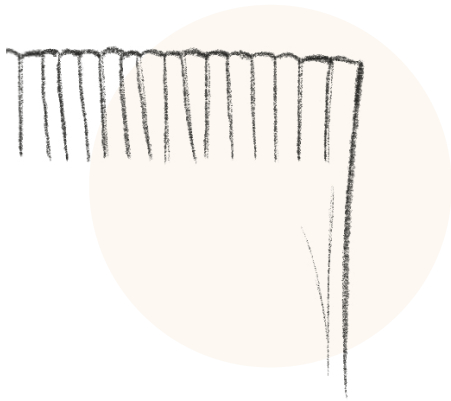

— Pencil Pleat 3" Tape

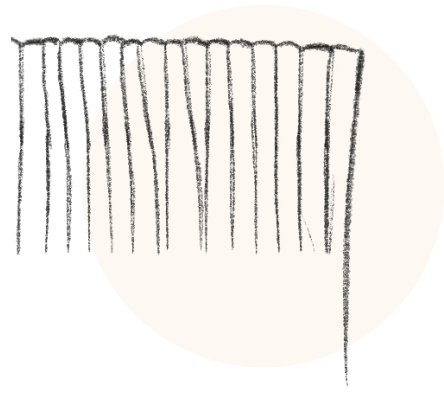

— Pencil Pleat 6" Tape

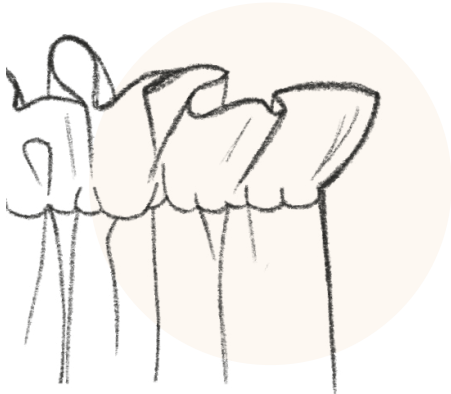

— Cottage Pleat



— Flop Over Frill

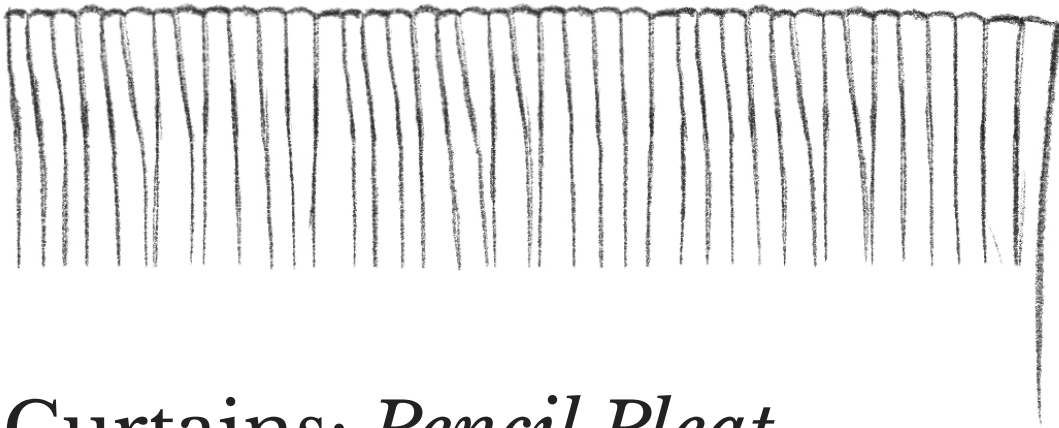

Curtains: *Pencil Pleat*

Slightly gathered to create a neat, simple drape and the most cost effective heading. Great in living rooms and paired back interiors. We recommend 3" for shorter curtains and 6" for longer curtains. You can gather and tie the curtain tape strings to create your required look. Comes as standard but can be ordered with extra fullness.

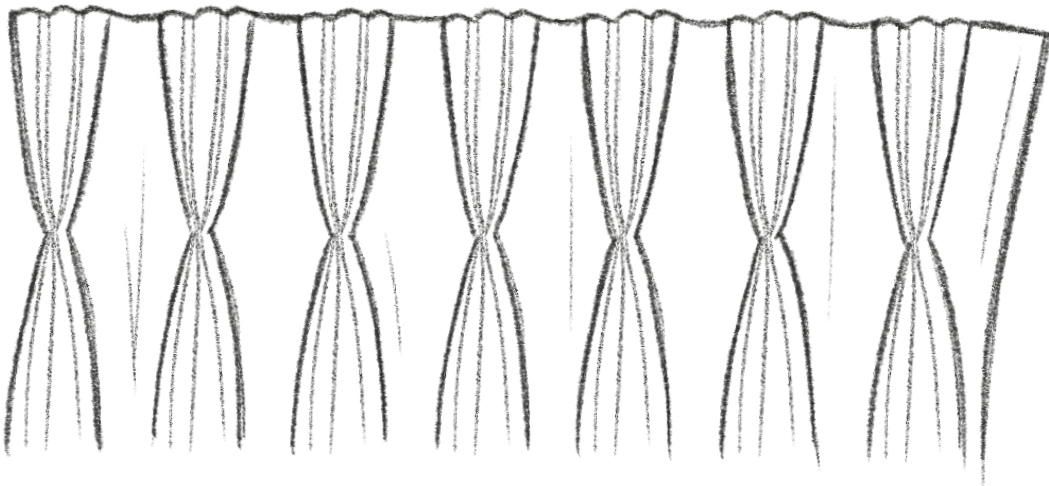

11

Curtains: *Pinch Pleat*

Double Pinch Pleat

A permanent double pleat on the header introduces a contemporary, tailored finish, a little less full than triple pinch and drapes beautifully. Comes as standard but can be ordered with extra fullness.

Triple Pinch Pleat

A permanent triple pleat on the header introduces a timeless and classic tailored finish, great for any room that is looking for added fullness and texture.

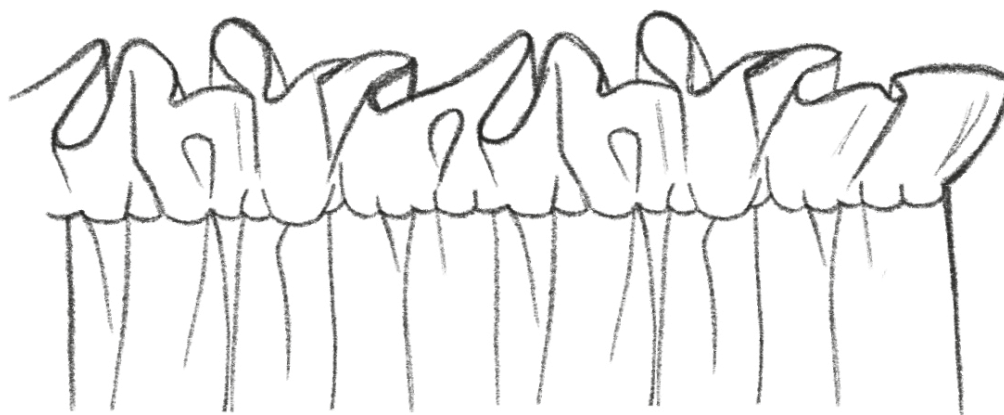

Curtains: *Cottage Pleat*

Available with 5cm or 10cm ruffle. A pretty informal heading that ruffles up above the curtain tape top that lends itself so well to softer, more relaxed interiors, beautiful in children's bedrooms and other relaxed settings. Works best with poles, you can gather the curtain tape strings to create your required look.

12



Curtains: *Flop Over Frill*

A very pretty heading with the deep flop over frill. Works beautifully in country homes and smart town houses too. Looks wonderful used as an inner door curtain and also with a puddle - Depth of frill can be ordered up to 30cm online but contact us if further depth required. Suited to curtain poles. A relaxed drape with wonderful drama. Comes as standard but can be ordered with extra fullness.

Details

Alternative linings

Roman blinds can also be made with a choice of alternative linings. Please choose from Tori Murphy fabric, *sateen twill*, *solprufe*, *thermal*, *blackout* or *supersoft*.

Blackout lining

Please note that with blackout lining some light will still be visible around the edges of the blind. We recommend that blinds extend approx 10cm beyond the window recess on all sides. Some light will also be visible along the stitch lines and this is unavoidable.

Premier head rail

Our 'premier' head rail is a fully enclosed system with a sidewinder mechanism. A pulley chain is used to operate the blind.

Chains

Please select either right hand or left hand control position for the blind and choose from chrome, brass or antique brass.

Chrome



Brass



Antique Brass



To allow us to comply with current health and safety legislation, please supply the following information when ordering:

Installation height: Measurement from the top of the blind to the floor.

Overall Drop of Blind: Measurement taken from the top of the blind to the bottom of the blind.

Tori Murphy Fabric

Add additional texture, interest and curb appeal by having Tori Murphy fabric on the back of your curtains or blinds.

Sateen Twill (off white)

Our standard lining, sateen twill is a light lining that gives a simple crease free finish.

Solprufe (off white)

Solprufe lining enables curtains to hold their shape, provide insulation and darken rooms effectively. It improves the look, drape and flow of curtains by adding weight. Solprufe linings enhance appearance and increase resistance to fading from sunlight.

Thermal (off white)

Thermal lining is an effective way to help keep heat in your rooms and cold air out during the cooler months. In summer thermal linings also help to keep rooms cooler.

Blackout (off white)

Blackout means that no light will pass through the blackout fabric and through to the room. Blackout lining has a coating that fills any gaps in the spaces of the lining fabric yet it still remains soft and allows for beautiful pleats and folds.

Supersoft (off white)

Supersoft is a very soft and cosy lining that not only helps block out the light but also adds wonderful warmth, texture and drape.

Roman Blinds

All roman blinds are fully lined with sateen twill as standard and are supplied complete with aluminium head rail and brackets and screws ready for hanging.

Blinds can be fitted on either the inside or outside of a window recess. We recommend you position your blind outside the recess if the window is not straight to avoid the blind catching or hanging incorrectly. Another reason for having the blind on the outside would be if your window opens inwards. If more than one blind is being fitted to a window (for example in a bay window), please order the blind size required for each window as this may vary.

1. Measure the width

To fit your blind inside the recess:

If ordering a blind to fit inside the recess, measure the width of the recess in 3 different positions and supply the smallest width and we will make the necessary allowances for you by deducting 0.5cm.

Please note any protrusions (such as tiles and wooden rails) and take the smallest width and drop measurement.

To fit your blind outside the recess:

Simply measure where you would like the blind to sit and supply that measurement. No allowance will be made and the dimensions supplied will include head rail and brackets.

We recommend that a blind does not extend more than 10cm either side of the window and approximately 10cm above and below. If the window ledge protrudes out we suggest that the blind sits just above or on the sill once closed.



2. Measure for the finished drop

To fit it to the recess:

Measure the recess drop in 3 different positions. Supply the smallest drop on the order form.

On the outside of the window (i.e. blind size):

Simply measure where you would like the blind to sit and supply that measurement.

3. Choose your fabric

4. Select which lining you require

5. Select position and colour of chain

Caring For Your *Made For Me* Products

When you unpack your Made For Me product, there may be creasing or pressure marks. These will normally fall out quickly after hanging in a warm room. Alternatively, your product may be lightly ironed with a warm dry iron on the reverse side. Hems and sides should never be pressed. Steam and excessive pressure or temperature should be avoided as these can stretch or shrink the fabric. The cords on pencil pleat curtains must be tied at the end before the heading can be gathered. To improve the drape of your curtains we recommend that once they have been dressed into an even fold, they be loosely tied with ribbon in two or three places. This will encourage the curtains to retain an even fold when the ties are released.

Ordering single curtains

Single curtains are available in all fabrics.

Ordering smaller curtains

Please email madeforme@torimurphy.com for any help needed

Ordering larger curtains

Please email madeforme@torimurphy.com for any help needed

Measuring

On page 6,7 & 8 we have provided a measuring guide for curtains and roman blinds. All orders must be placed with measurements given in centimetres. The conversion for inches to centimetres is 2.54cm to 1".

Ordering

Where possible place orders online at www.torimurphy.com but we are always happy to give you a helping hand with your order.

Please contact on 01158 241 305 or email madeforme@torimurphy.com with any questions.

Cancellations/amendments

Orders cannot be cancelled or amended once production has started.

Please contact on 01158 241 305 or email madeforme@torimurphy.com with your order number to check the status of your order. Any agreements to cancel or amend will be confirmed in writing.

Delivery Charges

Delivery is free to any UK address - Please contact 01158 241 305 or email madeforme@torimurphy.com for shipping quotes to all other addresses.

Proof of delivery

Please check all packages at the time of delivery. If the goods arrive via carrier, the consignment should only be signed for as '*received in good condition*' if you are completely satisfied that the goods contained are not damaged.

Return procedure

Claims or returns can only be made on Made For Me products if the item is faulty. If there are any issues with your order upon receipt, please contact the team on 01158 241 305 or email madeforme@torimurphy.com to discuss next steps.

Index

Cotton

Suitable for blinds and curtains. Due to the nature of the weave, strong light can come through the fabric so we recommend using Solprufe or Blackout lining if you want a darker room.



Harbour Stripe - Black



Harbour Stripe - Chestnut



Harbour Stripe - Fawn



Harbour Stripe - Mustard



Harbour Stripe - Rose



Harbour Stripe - Radish



Harbour Stripe - Claret



Harbour Stripe - Navy

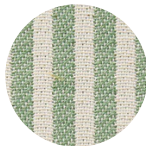

Harbour Stripe - Olive



Scallop Stripe - Black

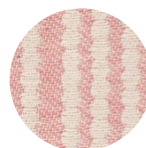

Scallop Stripe - Rose



Scallop Stripe - Mustard

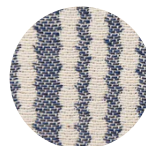

Scallop Stripe - Navy



Scallop Stripe - Claret



Bloom - Radish

Index



Sleeper Stripe - Black



Sleeper Stripe - Rose



Sleeper Stripe - Radish



Sleeper Stripe - Mustard



Sleeper Stripe - Navy



Woodhouse Check - Claret



Woodhouse Check - Chestnut



Woodhouse Check - Mustard



Woodhouse Check - Navy



Woodhouse Check - Radish



Woodhouse Check - Rose

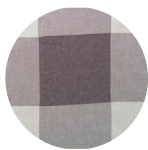

Large Woodhouse Check - Black

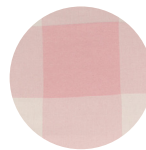

Large Woodhouse Check - Rose

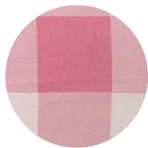

Large Woodhouse Check - Radish

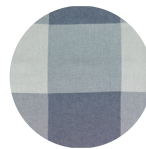

Large Woodhouse Check - Navy



Large Woodhouse Check - Mustard

Index

Wool

Suitable for blinds and curtains and due to the nature of the merino wool yarn, can add wonderful insulation. We would not recommend wool curtains or blinds in a bathroom.



Harbour Stripe - Black



Harbour Stripe - Mushroom



Harbour Stripe - Chestnut



Harbour Stripe - Rose



Harbour Stripe - Sage

18



Scallop Stripe - Black



Scallop Stripe - Mushroom



Scallop Stripe - Rose



Scallop Stripe - Sage



Scallop Stripe - Raspberry



Tutto Stripe - Black

We have a larger selection of Tori Murphy fabrics available on request. Please contact madeforme@torimurphy.com

All swatches available to order online www.torimurphy.com



We're always here to give you a helping hand, drop us a line below

01158 241 305

madeforme@torimurphy.com

WWW.TORIMURPHY.COM