

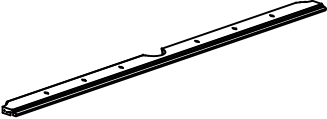

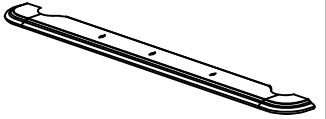

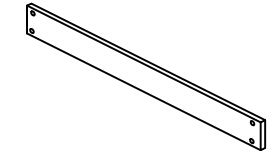

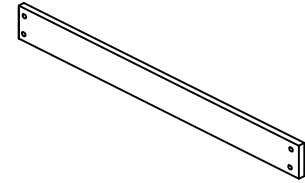

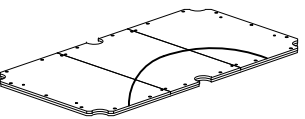
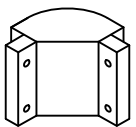
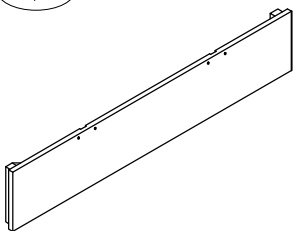
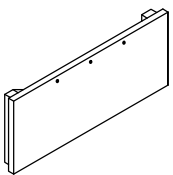
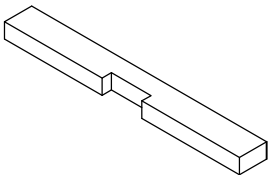
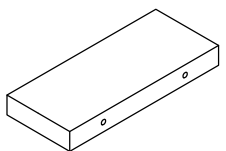
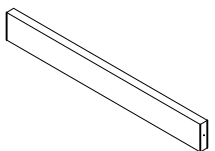

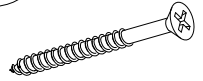

WOOD PARTS TABLE

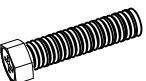
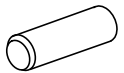
<p>1</p>  <p>Side top rail(2pcs)</p>	<p>2</p>  <p>End top rail(2pcs)</p>	<p>3</p>  <p>End blind(2pcs)</p>	<p>4</p>  <p>Side blind(2pcs)</p>	<p>5</p>  <p>Slate(3pcs)</p>	<p>6</p>  <p>Corner block(4pcs)</p>
<p>7</p>  <p>Side panel(2pcs)</p>	<p>8</p>  <p>End panel(2pcs)</p>	<p>9</p>  <p>End wooden block (2pcs)</p>	<p>10</p>  <p>Side wooden block (4pcs)</p>	<p>11</p>  <p>Beam (2pcs)</p>	<p>12</p>  <p>Leg (4pcs)</p>

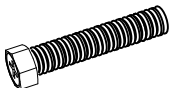
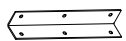
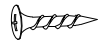
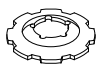
HARDWARE PARTS TABLE

<p>A</p>  <p>Ø3/8"X2" Hex bolt(34pcs)</p>	<p>B</p>  <p>Ø3/8" X Ø1" Flat washer(16pcs)</p>	<p>C</p>  <p>Ø1/4"XØ5/8" Flat Washer(18pcs)</p>	<p>D</p>  <p>Ø1/4"X2-3/4" Slate screw(16pcs)</p>	<p>E</p>  <p>Ø1/4"X2" Hex bolt(14pcs)</p>	<p>F</p>  <p>Ø5/16"XØ3/4" Flat washer(24pcs)</p>
<p>G</p>  <p>Ø5/16"X1-1/2" Hex bolt(16pcs)</p>	<p>H</p>  <p>Ø13/32"X1-3/16" Dowel (8pcs)</p>	<p>I</p>  <p>Ø5/16" Nut(4pcs)</p>	<p>J</p>  <p>Ø5/16"X2-1/4" Hex bolt(4pcs)</p>	<p>K</p>  <p>5"X1"X1" L metal bracket(14pcs)</p>	<p>L</p>  <p>Ø5/32"X1/2" Flat head screw(96pcs)</p>
<p>M</p>  <p>Ø3/8" Dome lock washer(18pcs)</p>	<p>N</p>  <p>Ø3/16"X1" Nail(24pcs)</p>	<p>O</p>  <p>POCKET CENTER Pocket(2pcs)</p>	<p>P</p>  <p>POCKET CORNER Pocket(4pcs)</p>	<p>Q</p>  <p>SHIM(1PC)</p>	<p>R</p>

STEP 1:

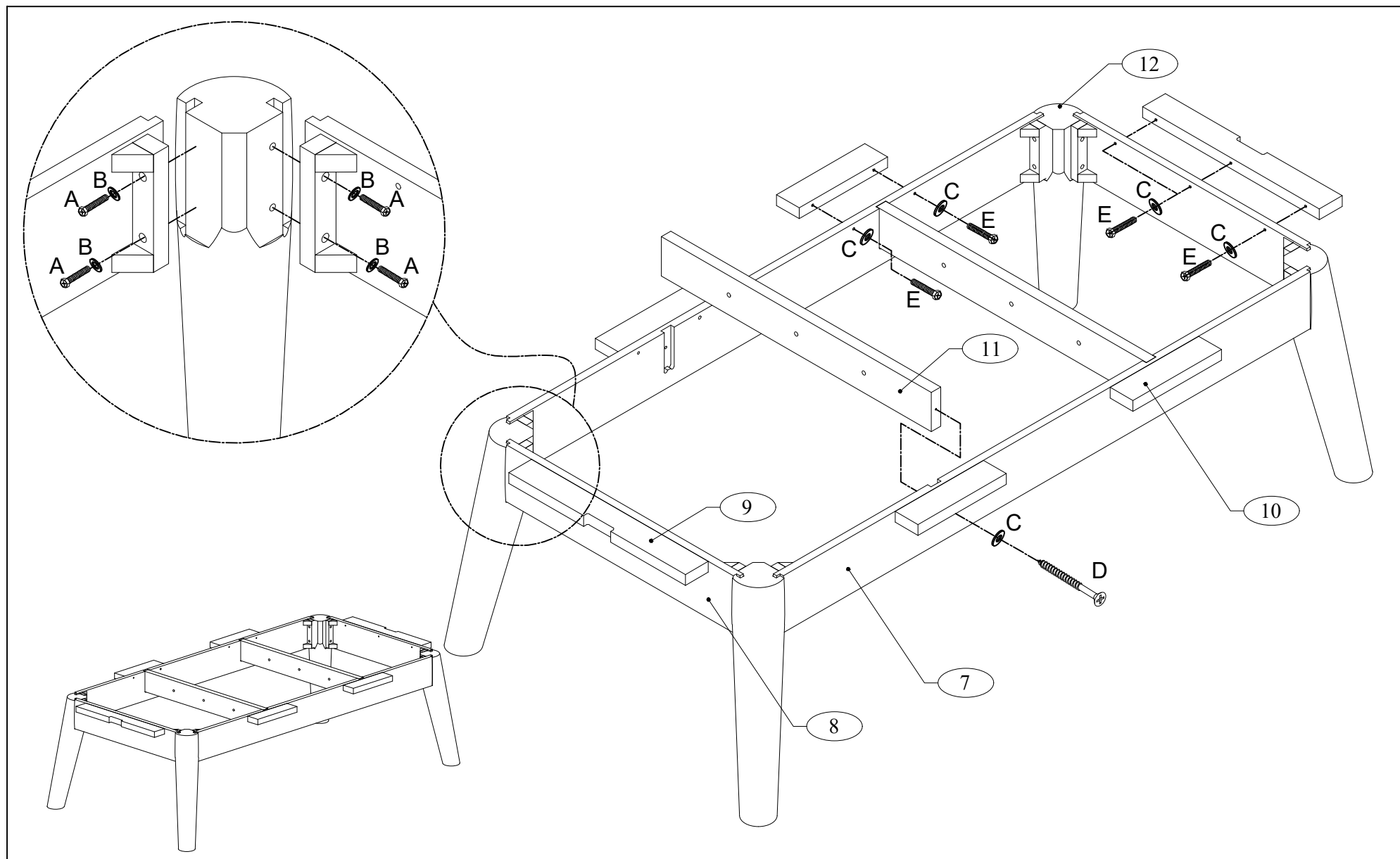

STEP 2:

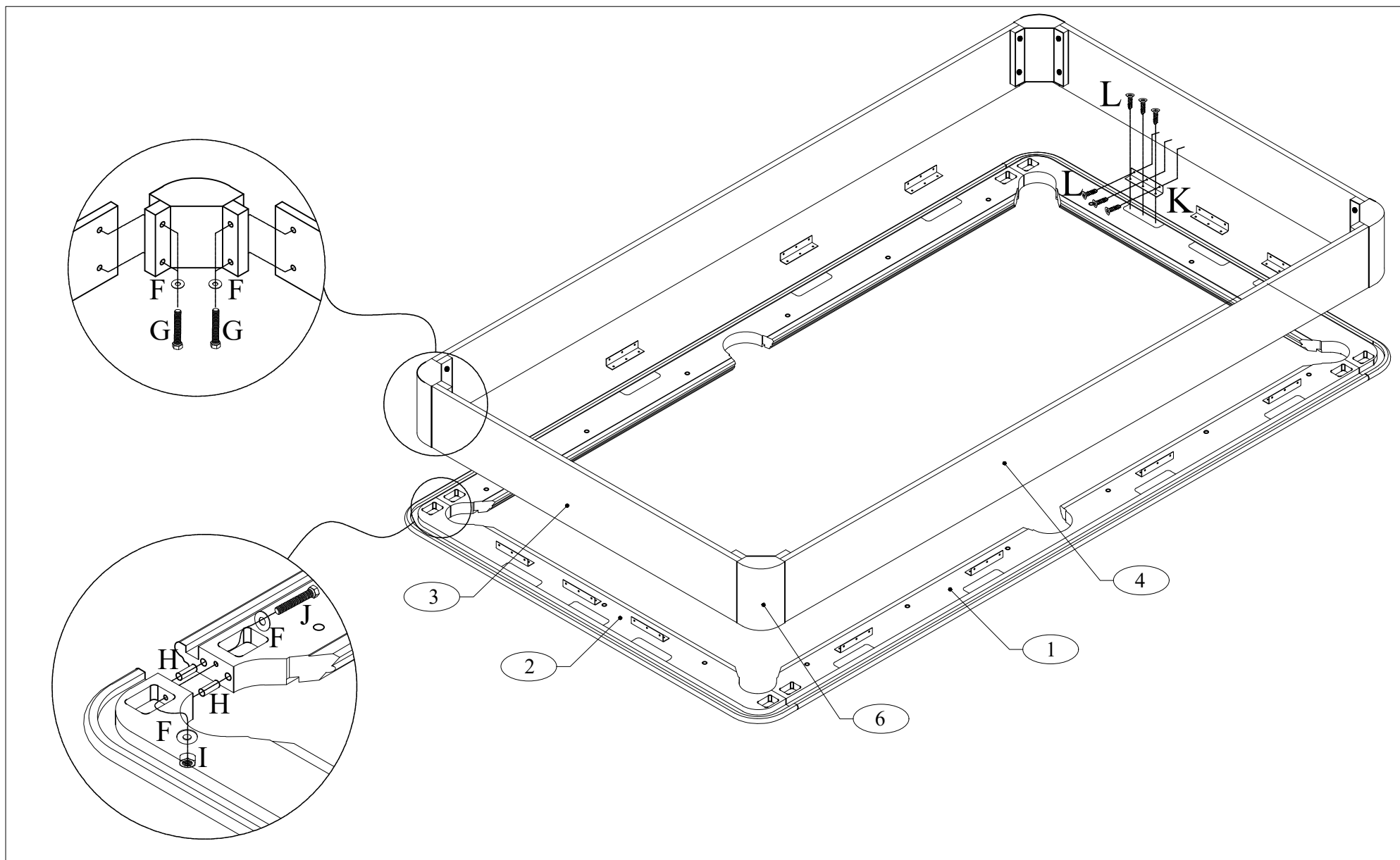

STEP 3:

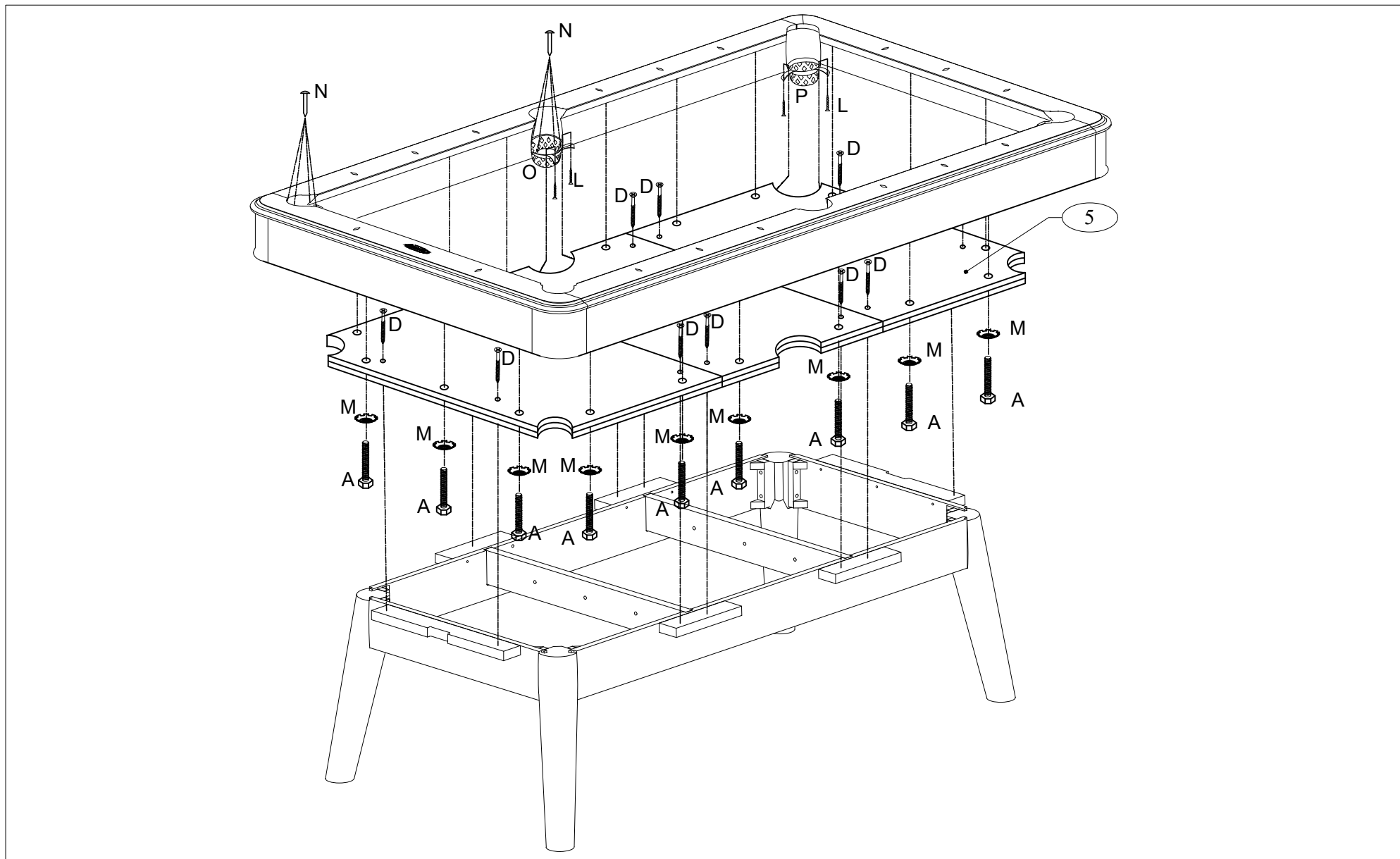

FINISH

