

Features

- 3D LED Color Temperature Lights with Dimmable touch control
- Mirrored interior with 3 adjustable glass shelves
- Includes Digital Clock
- Includes Defogger with push button
- Includes one USB outlet
- Includes an adjustable makeup mirror
- Includes installation hardware for recess mounting
- Can be recessed or surface mounted
(surface mounting is included)
- Interior Light with sensor switch
- Energy efficient LED lighting:

Kelvin	3000	6500	4500 mixed color
CRI	80+	80+	80+
Lumens*†	900	900	1800
R9 Value*	50+	50+	50+
Watts (AC)	60	60	60
Lumens per Watt	90	90	90

Construction

- Grey aluminum body and door frame
- 3 mirror design – rear of cabinet and both sides of door
- Concealed finger pull-door edge
- Three pieces DTC 155° self-closing hinges for each door
- Adjustable shelving at 2 1/3" (60 mm) increments
- Single field wire into electrical shelf - Front access serviceability

Codes/Standards Applicable

Electric Option Models are ETL certified to:

- UL 962
- CSA Standard C22.2 No. 68

Dimensions

Height: 36" (913 mm)

Width: 30" (762 mm)

Depth: 5" (127 mm) When surface mounted

1" (25 mm) When recessed

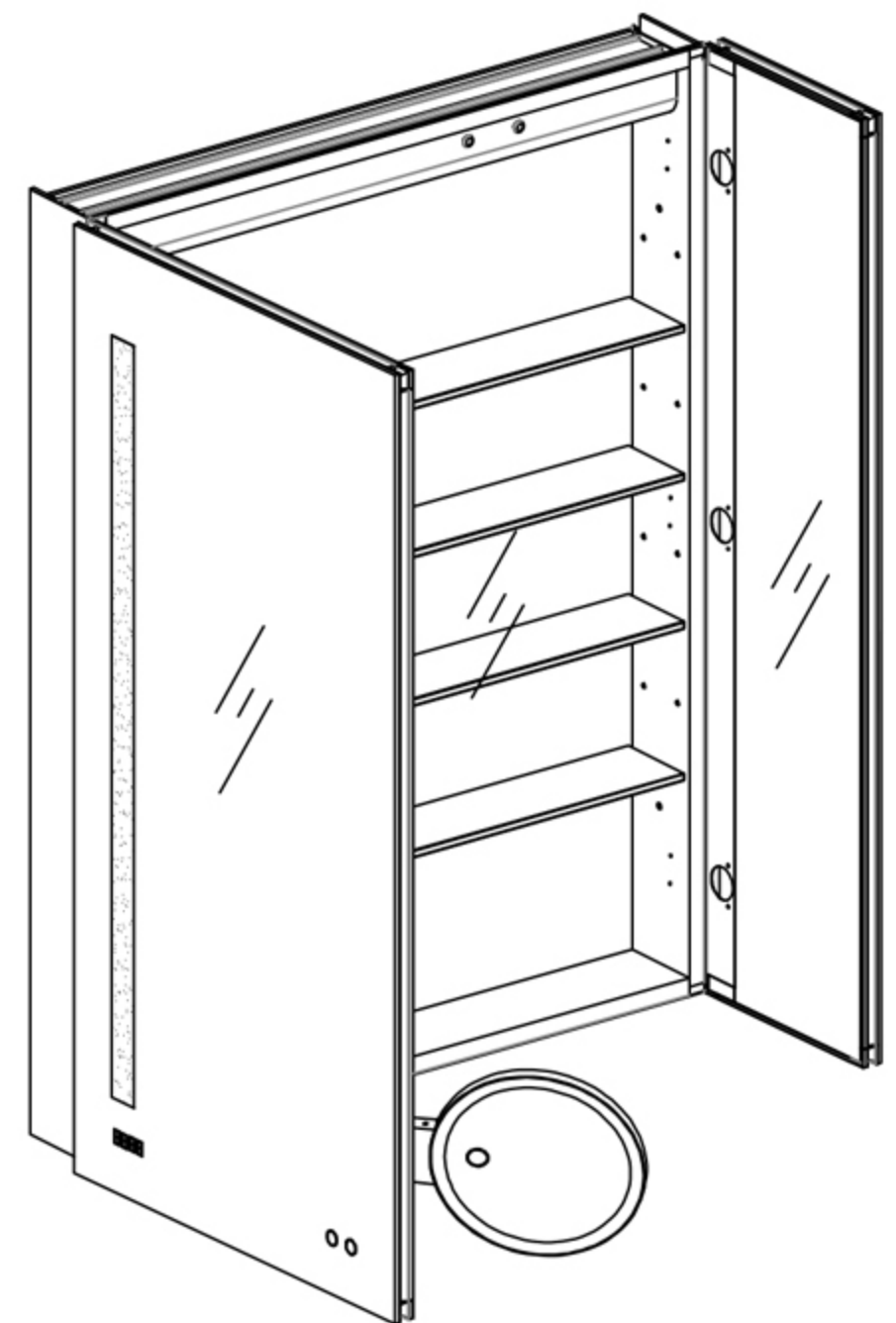
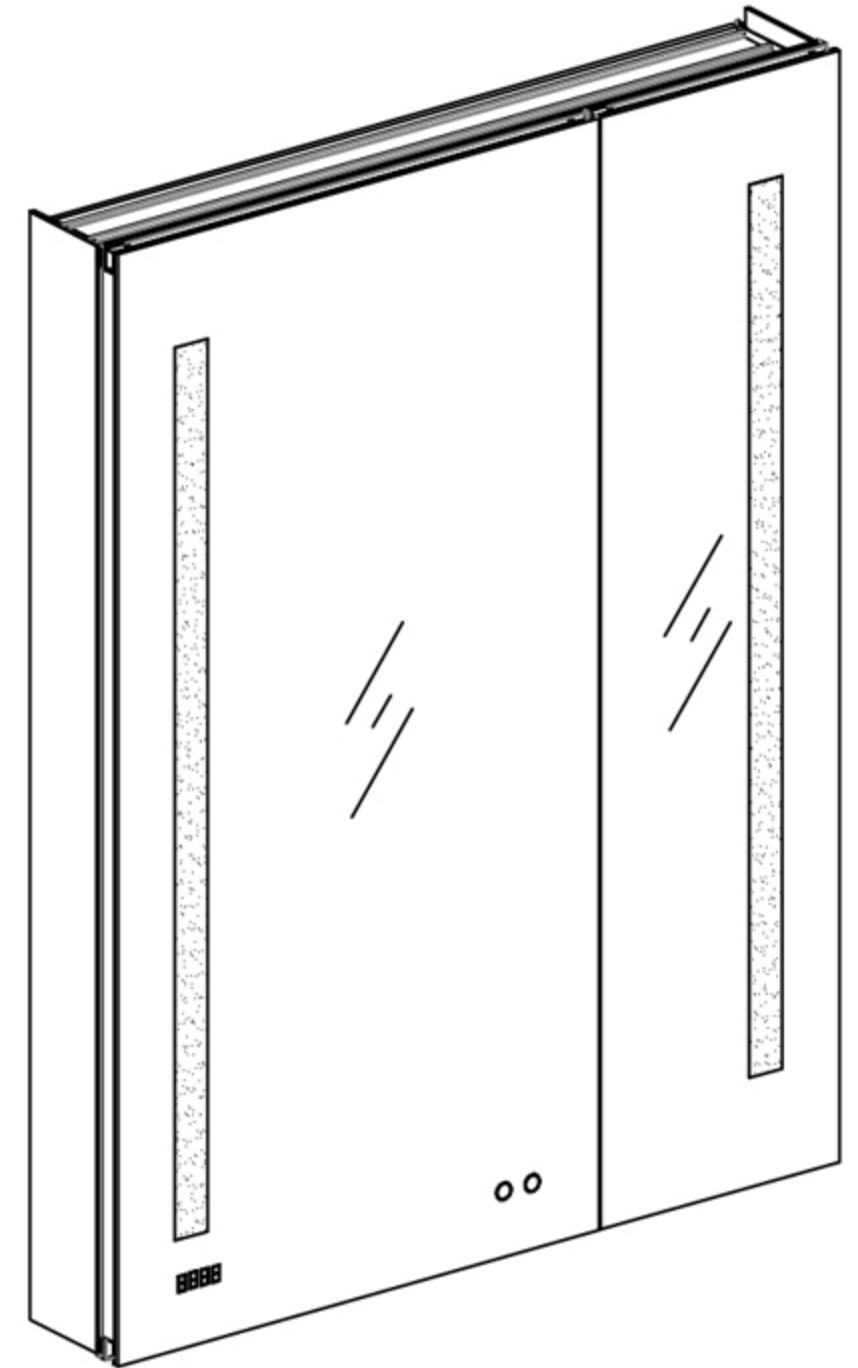

Installation Options

- Recessed Mount - Rough Opening - 35-1/2" H x 29-1/2" W x 4" D (901mm H x 749mm W x 102mm D)
- Surface Mount - Surface Mount Kit is included

Electrical System

- 60 Watts LED Driver
- INPUT : 120VAC 60HZ 1.2A
- OUTPUT : 12VAC 5.0A
- Field wire location as shown in drawing
- 1/2" conduit (Ø 7/8" actual) electrical knockout location shown below
- Included field wire cable clamp
- Circuit Diagram

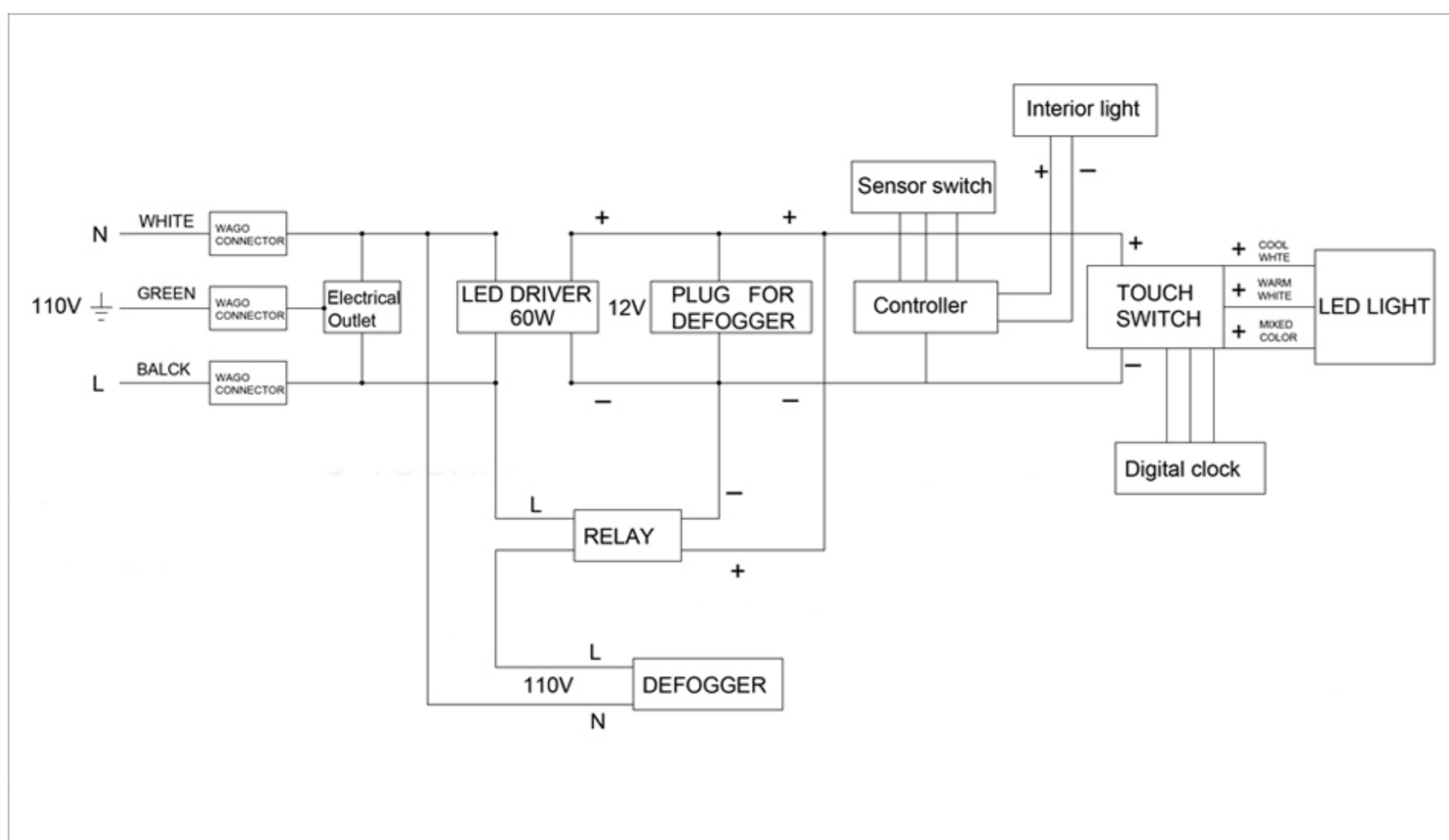

Circuit Diagram

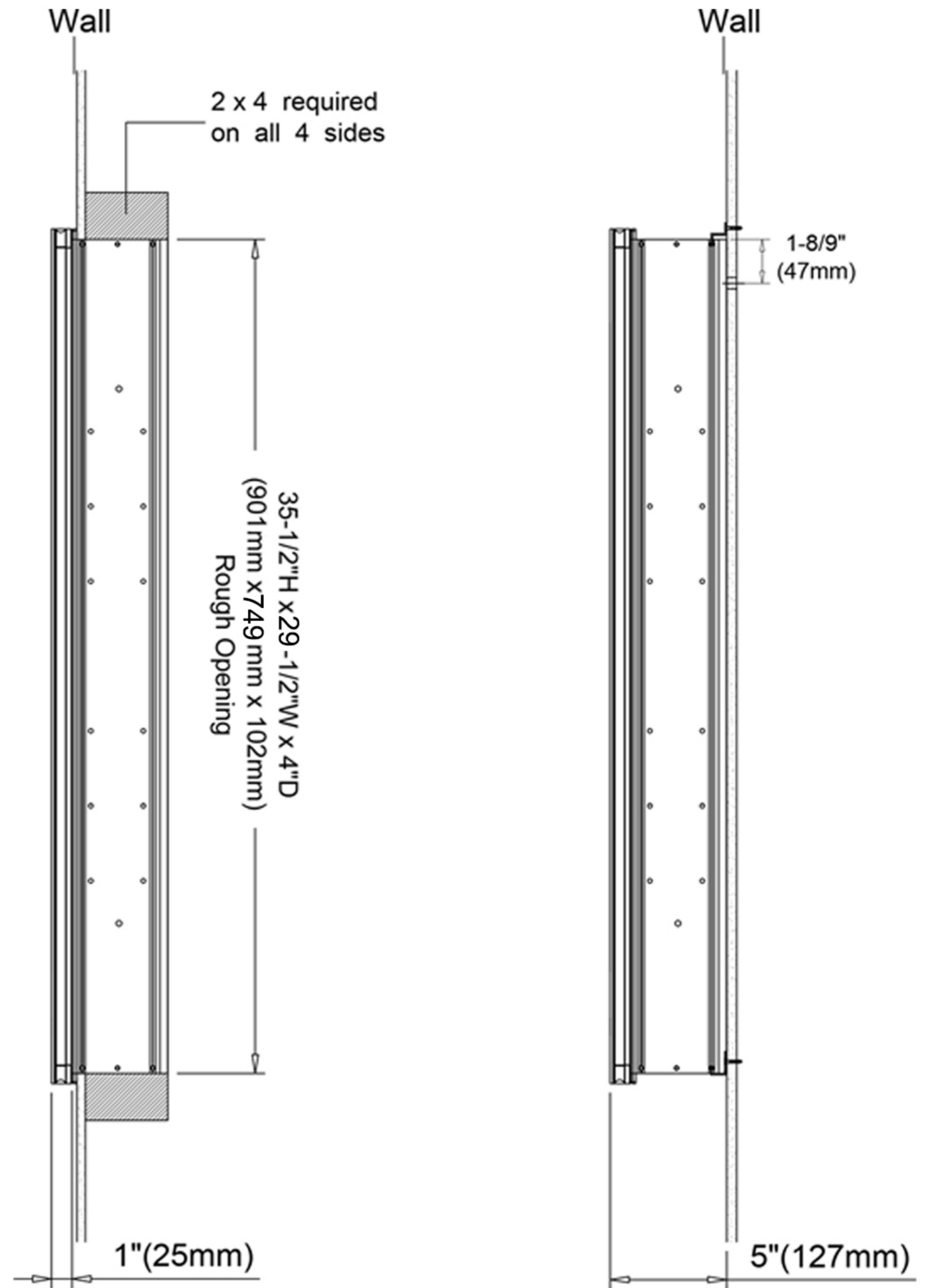

Recessed Mount

Surface Mount

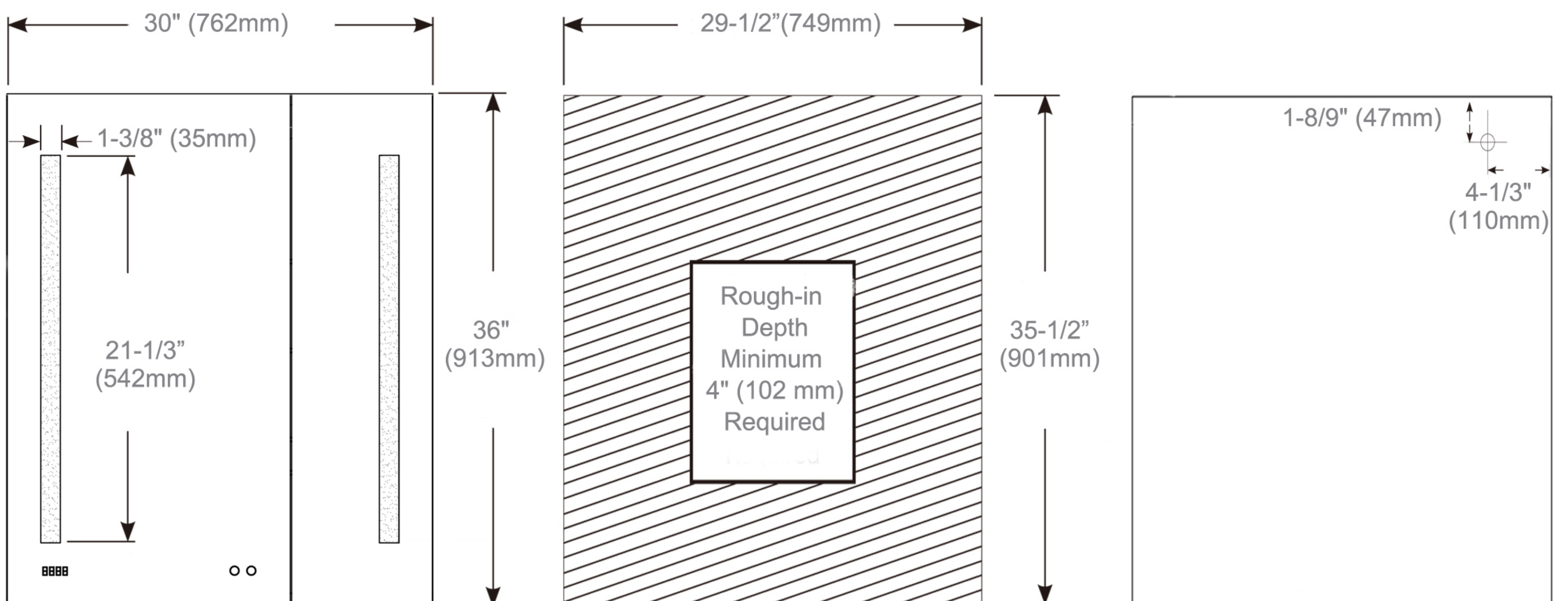

Cabinet Dimensions

Rough-in Dimensions

Back of Cabinet - Wire Access Location