

**PARK LANE SINGLE RAIL**

**PARK-1-E-60-600-xx**

18 July 2023

<b>UB</b> - UNLACQUERED BRASS	<b>BB</b> - BRUSHED BRASS
<b>CP</b> - POLISHED CHROME	<b>BC</b> - BRUSHED CHROME
<b>NP</b> - POLISHED NICKEL	<b>BN</b> - BRUSHED NICKEL
<b>LB</b> - LIGHT ANTIQUE BRONZE	<b>LAB</b> - LIGHT ANTIQUE BRONZE
<b>MB</b> - MEDIUM BRONZE	<b>MAB</b> - MEDIUM ANTIQUE BRONZE
<b>DB</b> - DARK BRONZE	<b>DAB</b> - DARK ANTIQUE BRONZE
<b>GP</b> - GOLD PLATED	<b>BG</b> - BRUSHED GOLD
<b>GM</b> - GUN METAL	<b>AG</b> - ANTIQUE GOLD
<b>MWP</b> - MATT WHITE P.COAT	<b>MBP</b> - MATT BLACK P.COAT

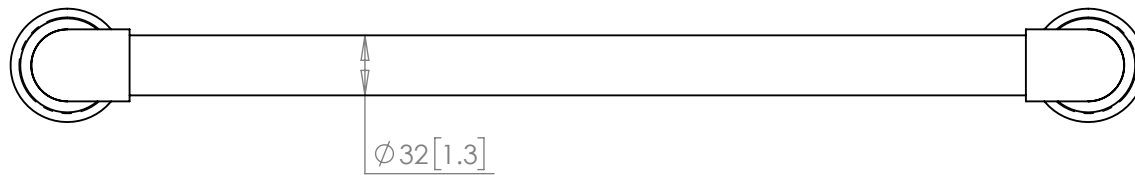
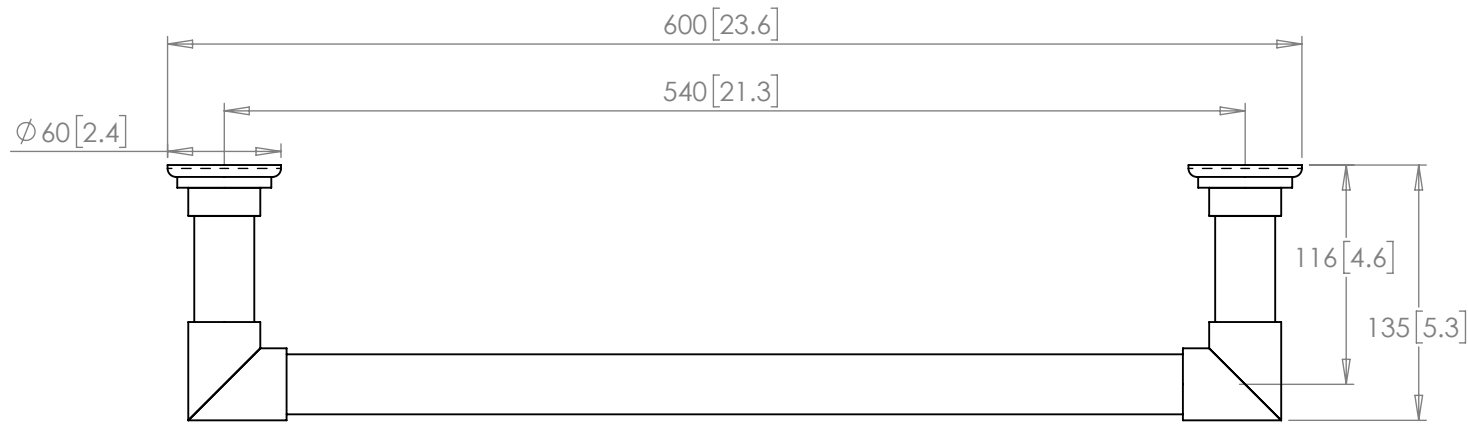
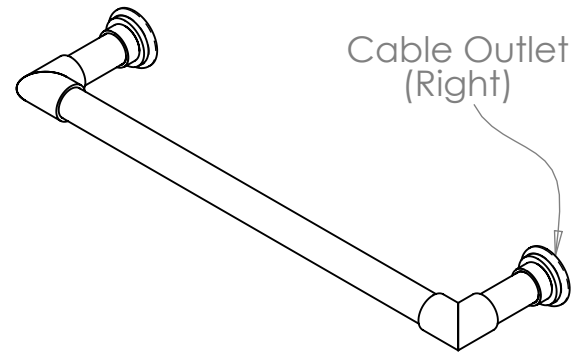

**THE STERLINGHAM** CO. LTD.

SCALE: 1:5 | APPROX WEIGHT 1.03KG

MANUFACTURED FROM BRASS

Units 2 & 2A Stamford Street  
Amblecote, Stourbridge,  
Worcestershire  
England, DY8 4HR

Telephone : 01384 370901  
Fax : 01384 880159  
sales@sterlingham.co.uk  
USsales@sterlingham.co.uk  
www.sterlingham.co.uk



Handmade  
*in the heart of*  
BRITAIN

**PARK LANE SINGLE RAIL**

**PARK-CLA-1-E-82-600-xx**

26 July 2023

<b>UB</b> - UNLACQUERED BRASS	<b>BB</b> - BRUSHED BRASS
<b>CP</b> - POLISHED CHROME	<b>BC</b> - BRUSHED CHROME
<b>NP</b> - POLISHED NICKEL	<b>BN</b> - BRUSHED NICKEL
<b>LB</b> - LIGHT ANTIQUE BRONZE	<b>LAB</b> - LIGHT ANTIQUE BRONZE
<b>MB</b> - MEDIUM BRONZE	<b>MAB</b> - MEDIUM ANTIQUE BRONZE
<b>DB</b> - DARK BRONZE	<b>DAB</b> - DARK ANTIQUE BRONZE
<b>GP</b> - GOLD PLATED	<b>BG</b> - BRUSHED GOLD
<b>GM</b> - GUN METAL	<b>AG</b> - ANTIQUE GOLD
<b>MWP</b> - MATT WHITE P.COAT	<b>MBP</b> - MATT BLACK P.COAT

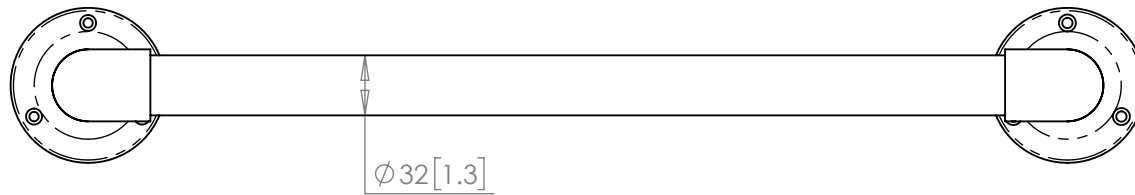
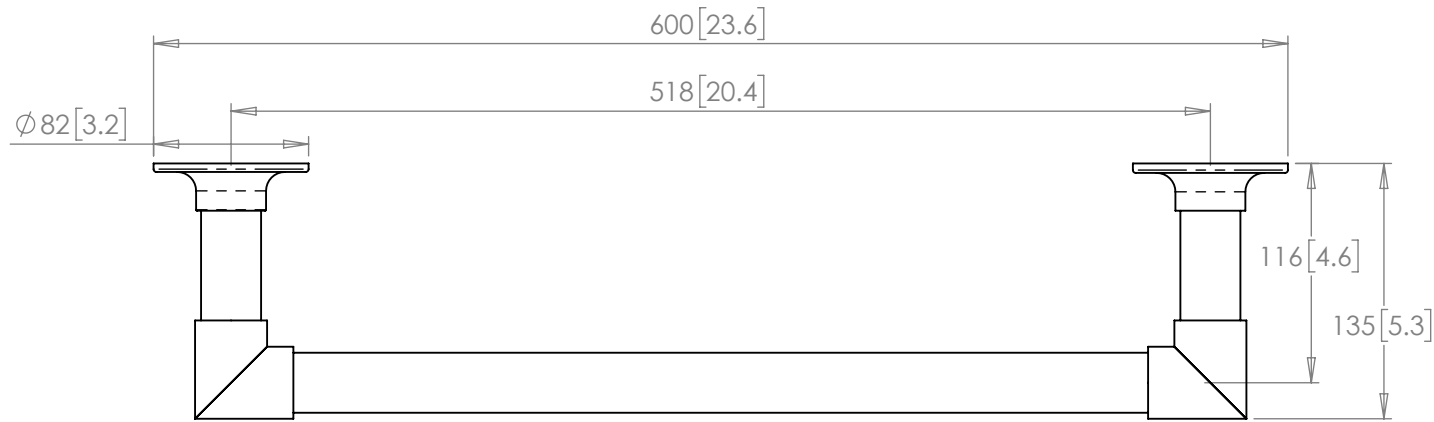
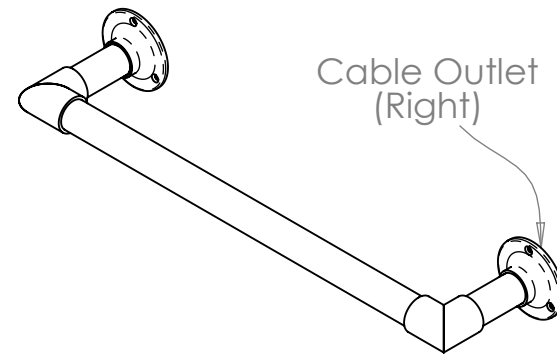

**THE STERLINGHAM** CO. LTD.

SCALE: 1:5 | APPROX WEIGHT 0.83KG

MANUFACTURED FROM BRASS

Units 2 & 2A Stamford Street  
Amblecote, Stourbridge,  
Worcestershire  
England, DY8 4HR

Telephone : 01384 370901  
Fax : 01384 880159  
sales@sterlingham.co.uk  
USsales@sterlingham.co.uk  
www.sterlingham.co.uk



Handmade  
*in the heart of*  
BRITAIN

**PARK LANE SINGLE RAIL**

**PARK-CLD-1-E-82-600-xx**

26 July 2023

<b>UB</b> - UNLACQUERED BRASS	<b>BB</b> - BRUSHED BRASS
<b>CP</b> - POLISHED CHROME	<b>BC</b> - BRUSHED CHROME
<b>NP</b> - POLISHED NICKEL	<b>BN</b> - BRUSHED NICKEL
<b>LB</b> - LIGHT ANTIQUE BRONZE	<b>LAB</b> - LIGHT ANTIQUE BRONZE
<b>MB</b> - MEDIUM BRONZE	<b>MAB</b> - MEDIUM ANTIQUE BRONZE
<b>DB</b> - DARK BRONZE	<b>DAB</b> - DARK ANTIQUE BRONZE
<b>GP</b> - GOLD PLATED	<b>BG</b> - BRUSHED GOLD
<b>GM</b> - GUN METAL	<b>AG</b> - ANTIQUE GOLD
<b>MWP</b> - MATT WHITE P.COAT	<b>MBP</b> - MATT BLACK P.COAT

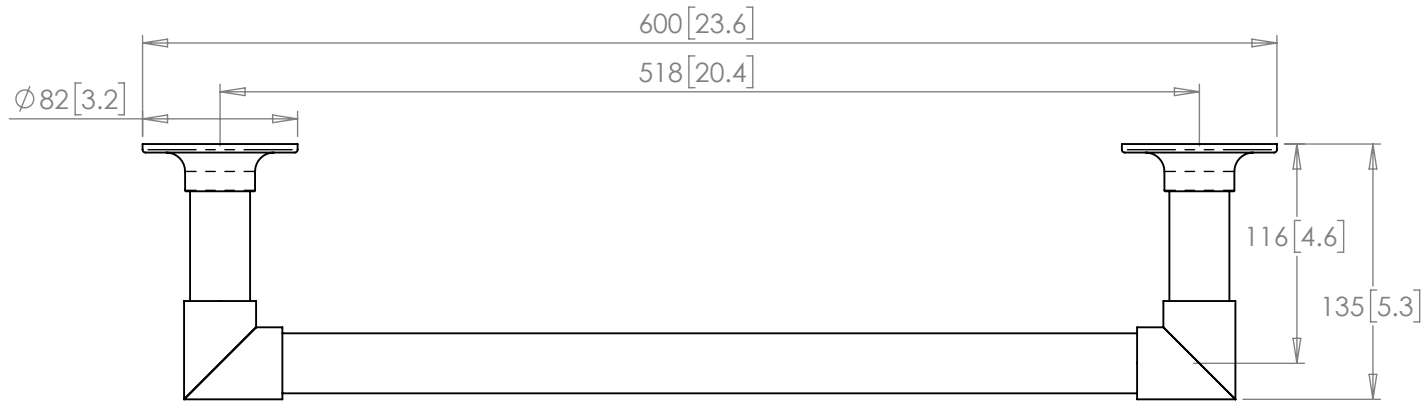
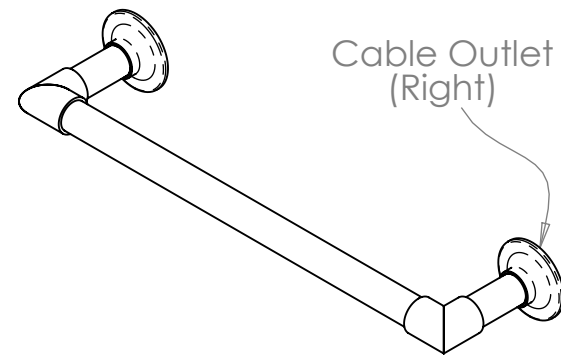

**THE STERLINGHAM** CO. LTD.

SCALE: 1:5 | APPROX WEIGHT 0.79KG

MANUFACTURED FROM BRASS

Units 2 & 2A Stamford Street  
Amblecote, Stourbridge,  
Worcestershire  
England, DY8 4HR

Telephone : 01384 370901  
Fax : 01384 880159  
sales@sterlingham.co.uk  
USsales@sterlingham.co.uk  
www.sterlingham.co.uk



Handmade  
*in the heart of*  
BRITAIN

**PARK LANE SINGLE RAIL**

**PARK-KNU-1-E-38-600-xx**

26 July 2023

<b>UB</b> - UNLACQUERED BRASS	<b>BB</b> - BRUSHED BRASS
<b>CP</b> - POLISHED CHROME	<b>BC</b> - BRUSHED CHROME
<b>NP</b> - POLISHED NICKEL	<b>BN</b> - BRUSHED NICKEL
<b>LB</b> - LIGHT ANTIQUE BRONZE	<b>LAB</b> - LIGHT ANTIQUE BRONZE
<b>MB</b> - MEDIUM BRONZE	<b>MAB</b> - MEDIUM ANTIQUE BRONZE
<b>DB</b> - DARK BRONZE	<b>DAB</b> - DARK ANTIQUE BRONZE
<b>GP</b> - GOLD PLATED	<b>BG</b> - BRUSHED GOLD
<b>GM</b> - GUN METAL	<b>AG</b> - ANTIQUE GOLD
<b>MWP</b> - MATT WHITE P.COAT	<b>MBP</b> - MATT BLACK P.COAT

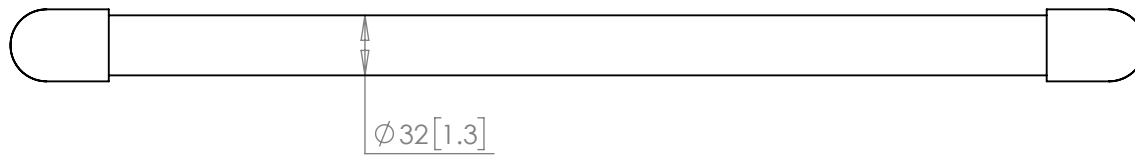
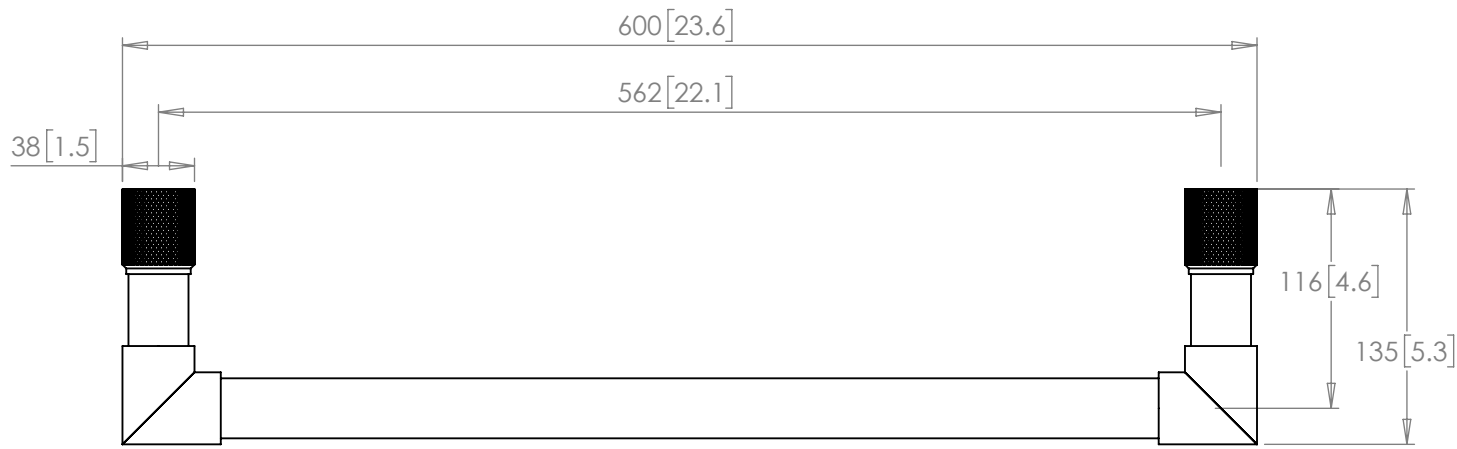
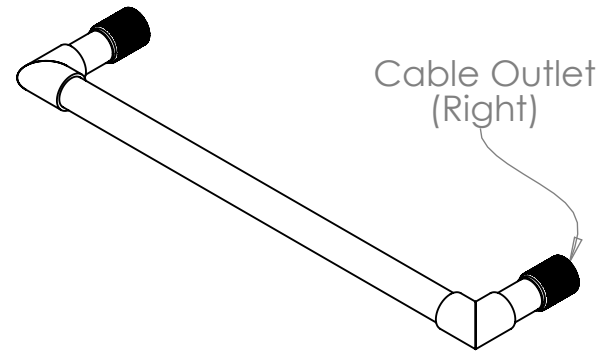

**THE STERLINGHAM** CO. LTD.

SCALE: 1:5 | APPROX WEIGHT 0.53KG

MANUFACTURED FROM BRASS

Units 2 & 2A Stamford Street  
Amblecote, Stourbridge,  
Worcestershire  
England, DY8 4HR

Telephone : 01384 370901  
Fax : 01384 880159  
sales@sterlingham.co.uk  
USsales@sterlingham.co.uk  
www.sterlingham.co.uk



Handmade  
*in the heart of*  
BRITAIN

**PARK LANE SINGLE RAIL**

**PARK-NOF-1-E-38-600-xx**

26 July 2023

<b>UB</b> - UNLACQUERED BRASS	<b>BB</b> - BRUSHED BRASS
<b>CP</b> - POLISHED CHROME	<b>BC</b> - BRUSHED CHROME
<b>NP</b> - POLISHED NICKEL	<b>BN</b> - BRUSHED NICKEL
<b>LB</b> - LIGHT ANTIQUE BRONZE	<b>LAB</b> - LIGHT ANTIQUE BRONZE
<b>MB</b> - MEDIUM BRONZE	<b>MAB</b> - MEDIUM ANTIQUE BRONZE
<b>DB</b> - DARK BRONZE	<b>DAB</b> - DARK ANTIQUE BRONZE
<b>GP</b> - GOLD PLATED	<b>BG</b> - BRUSHED GOLD
<b>GM</b> - GUN METAL	<b>AG</b> - ANTIQUE GOLD
<b>MWP</b> - MATT WHITE P.COAT	<b>MBP</b> - MATT BLACK P.COAT

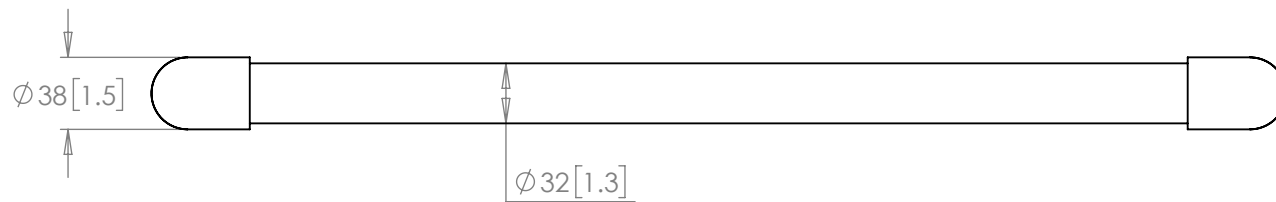
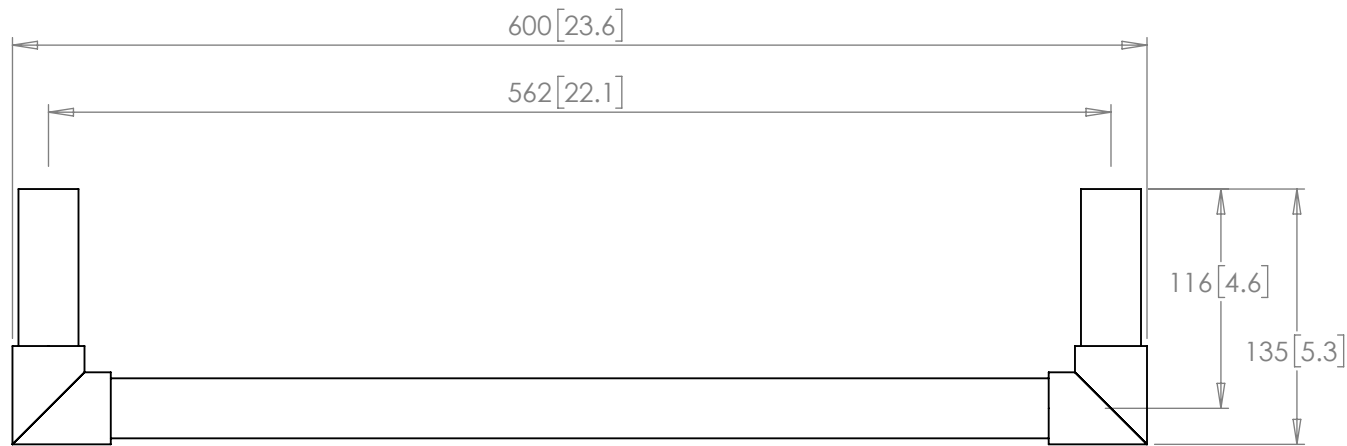
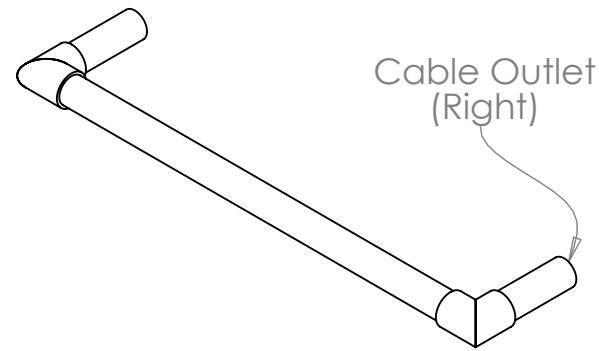

**THE STERLINGHAM<sup>CO.</sup> LTD.**

SCALE: 1:5 | APPROX WEIGHT 0.50KG

MANUFACTURED FROM BRASS

Units 2 & 2A Stamford Street  
Amblecote, Stourbridge,  
Worcestershire  
England, DY8 4HR

Telephone : 01384 370901  
Fax : 01384 880159  
sales@sterlingham.co.uk  
USsales@sterlingham.co.uk  
www.sterlingham.co.uk



Handmade  
*in the heart of*  
BRITAIN