

artos

MR12045P

INSTALLATION GUIDE

ryton towel warmer,
plug-in

BRUSHED NICKEL(BN)



CHROME(CH)



POLISHED NICKEL(PN)

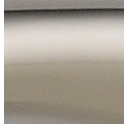

OIL RUBBED BRONZE(OB)

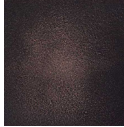

artos

MR12045P

ryton towel warmer,
plug-in

OPERATING SPECIFICATIONS



FEATURES

Towel warming, drying and auxiliary heating.

ELEMENT

300W, 110V

CODES

UL Approved
CSA-US Approved

REQUIREMENTS

The towel warmer must be installed so that the Element is at the bottom.

artos

MR12045P

PRODUCT DIMENSIONS

ryton towel warmer,
plug-in

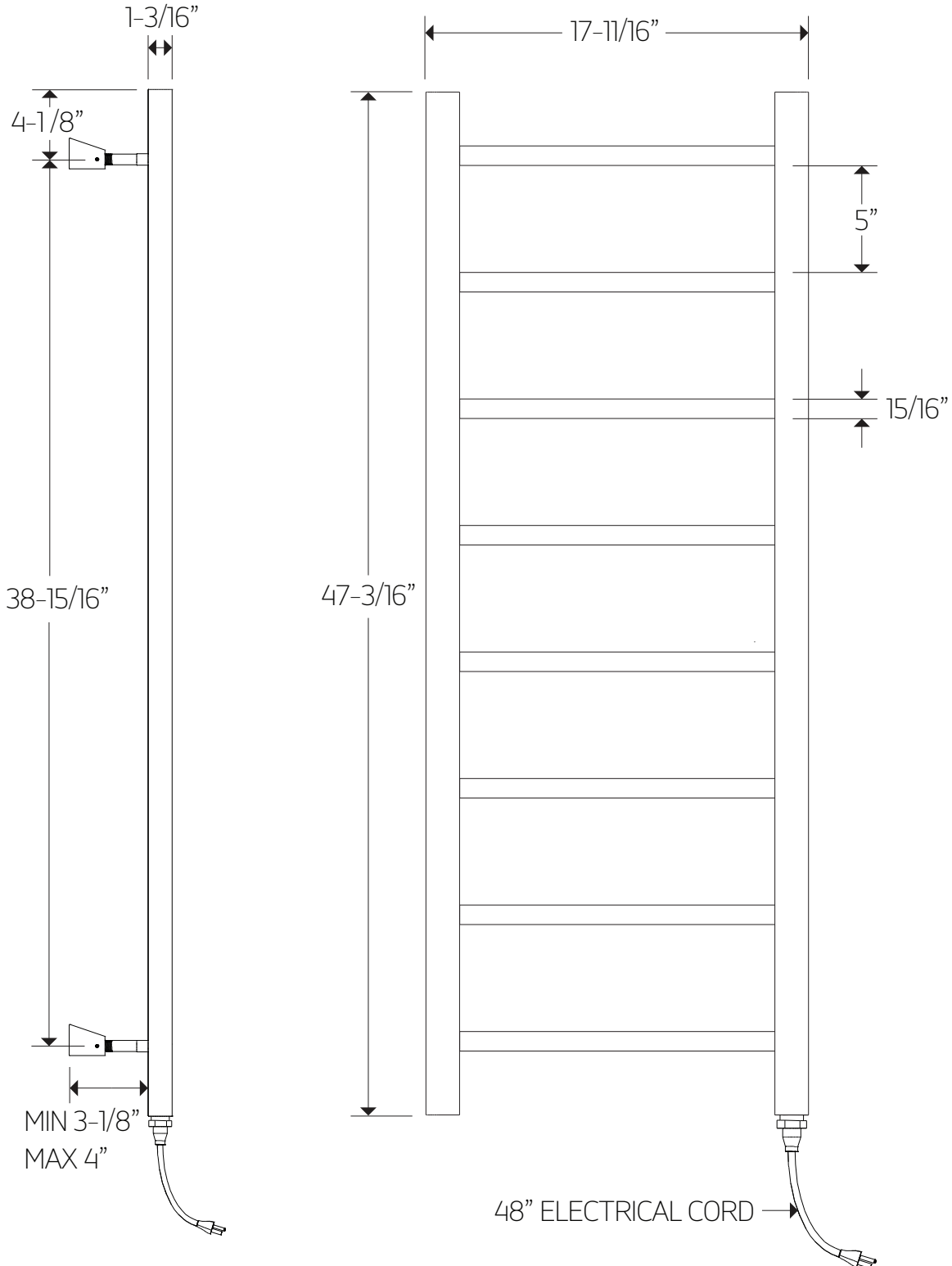

artos

MR12045P

ryton towel warmer,
plug-in

STEP 1

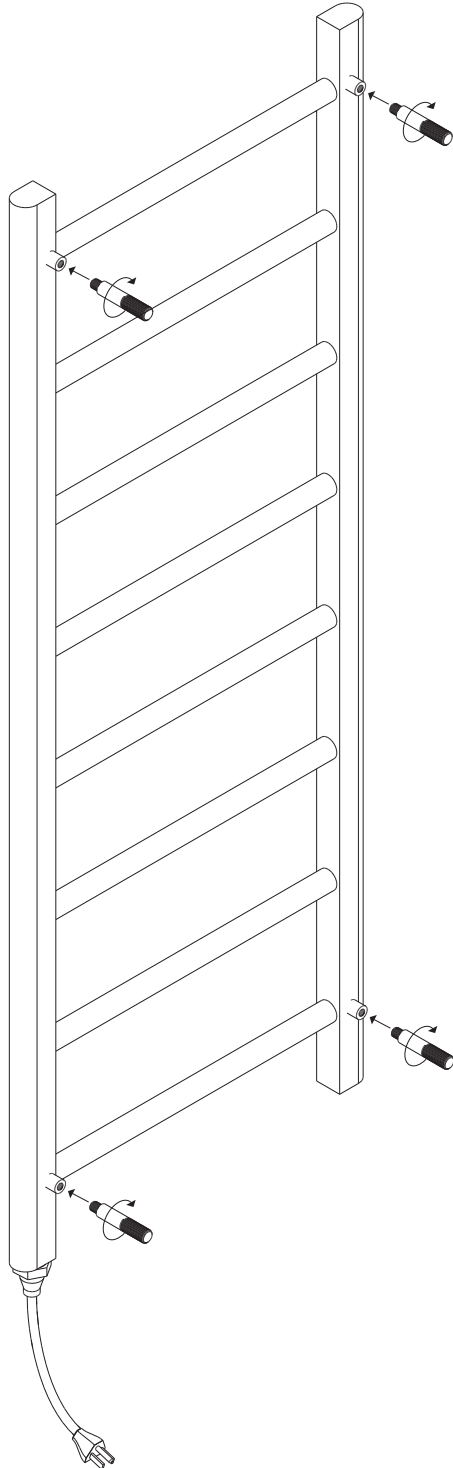

STEP 2

*ALL DIMENSIONS ARE APPROXIMATE

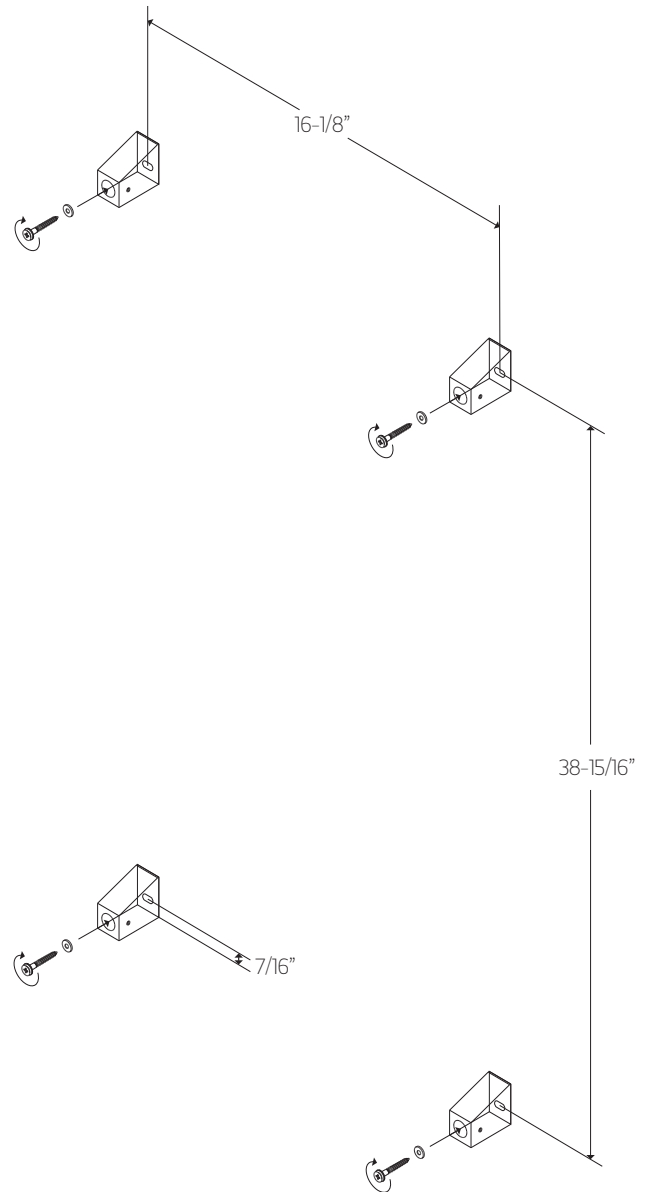

WE RECOMMEND THAT AT LEAST
2 OF THE WALL BRACKETS ARE
SECURED INTO A STUD OR BACKER

INSTALLATION STEPS

STEP 3

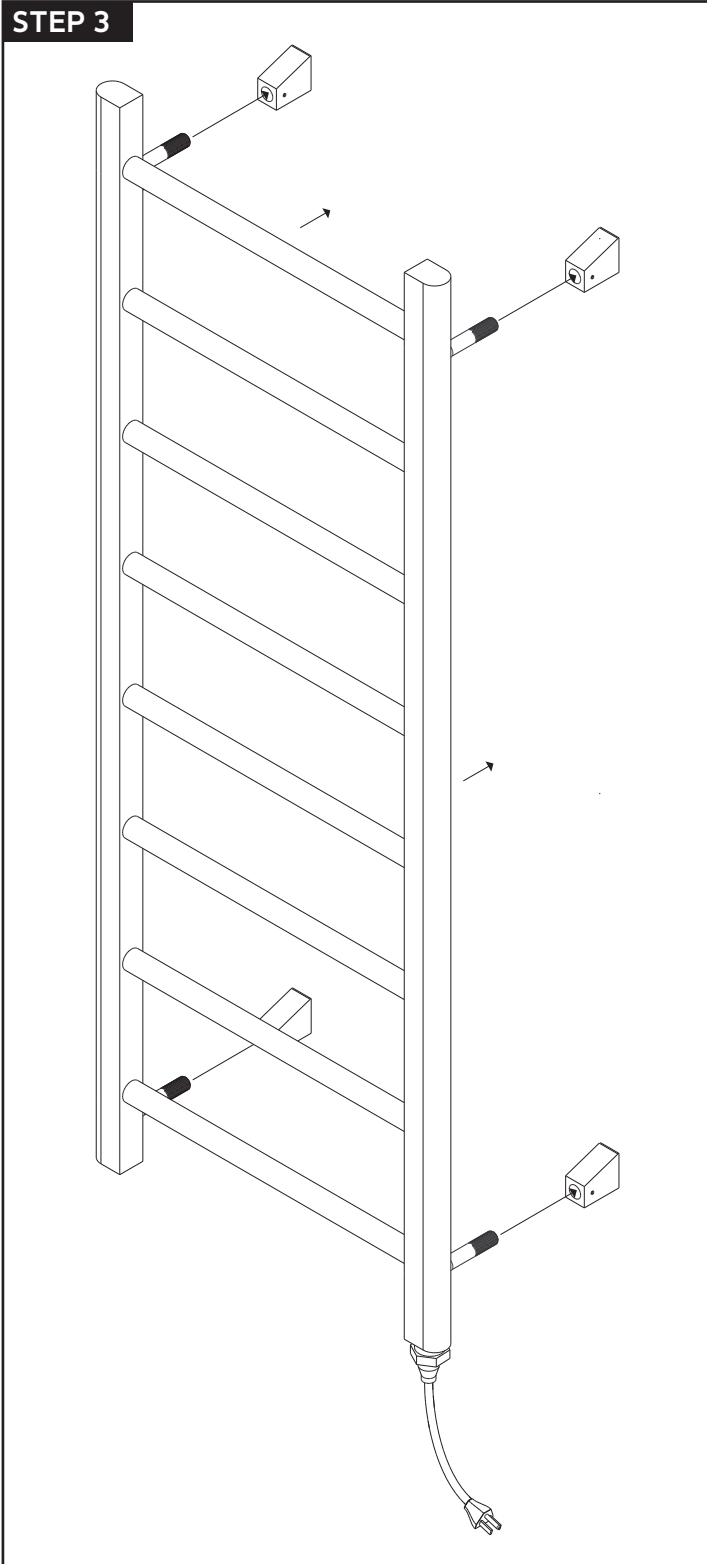

STEP 4

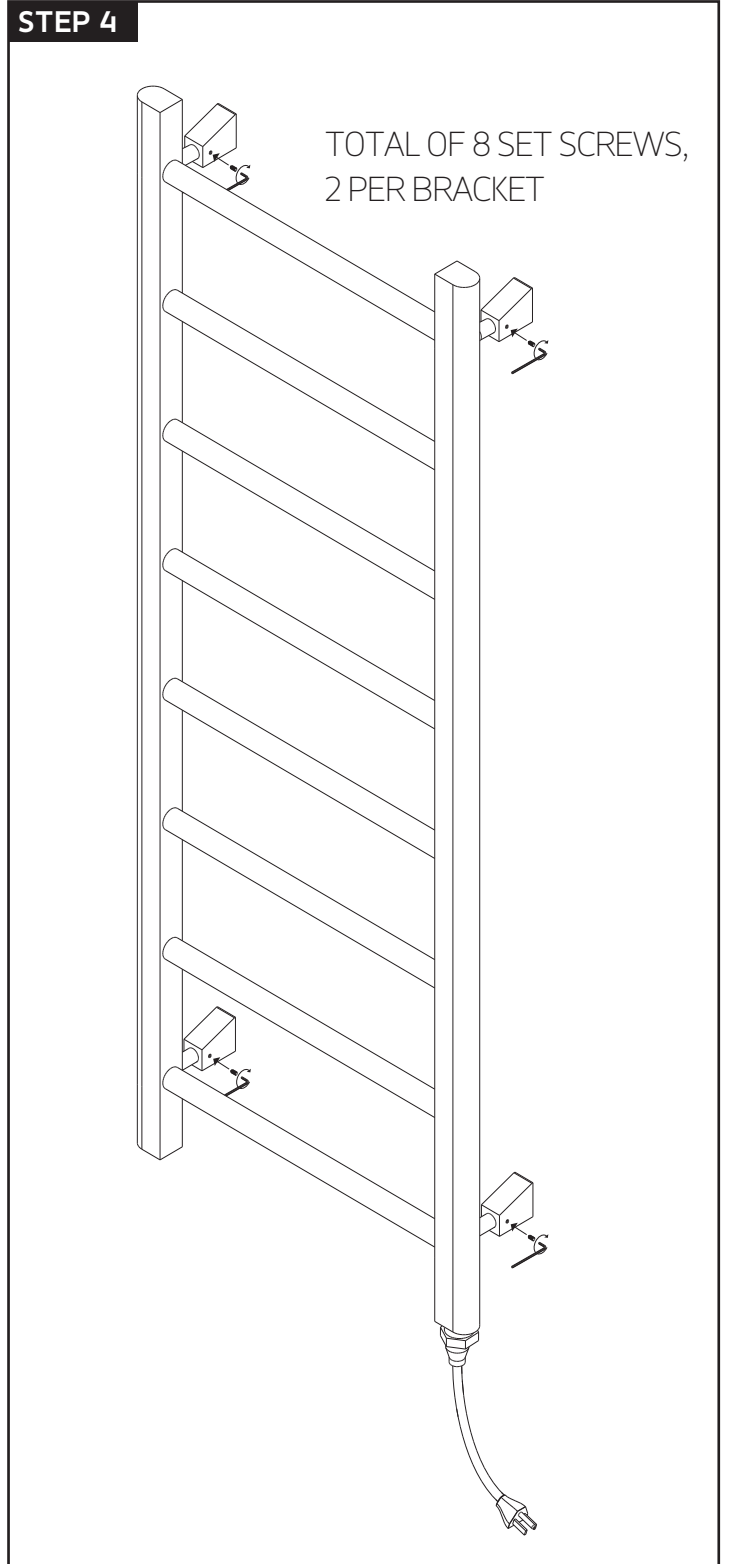

artos

MR12045P

ryton towel warmer,
plug-in

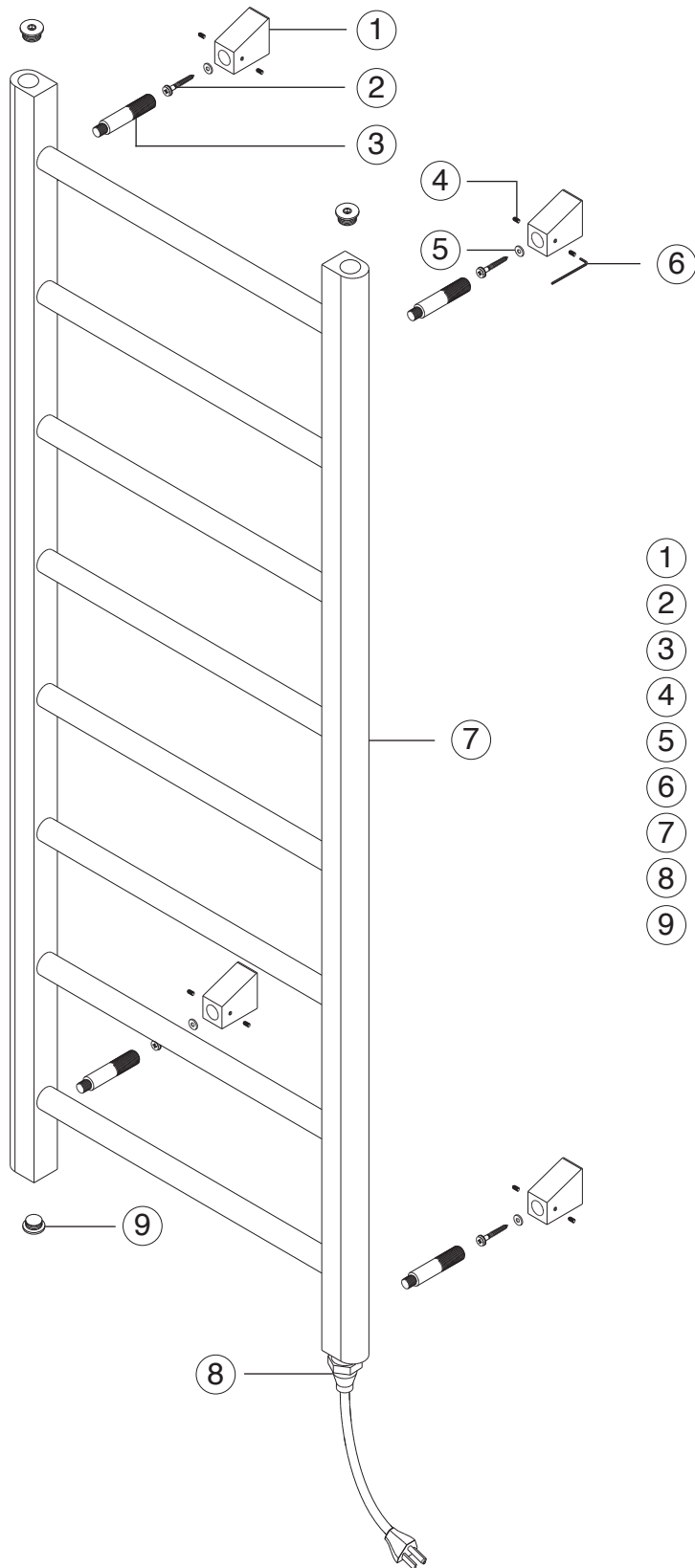

- ① **BRACKETS(4)** MR12045P XP1
- ② **BRACKET SCREWS(4)** MR12045P XP2
- ③ **BRACKET LEGS(4)** MR12045P XP3
- ④ **BRACKET SET SCREWS(8)** MR12045P XP4
- ⑤ **BRACKET WASHERS(4)** MR12045P XP5
- ⑥ **ALLEN WRENCH** MR12045P XP6
- ⑦ **TOWEL WARMER** MR12045P XP7
- ⑧ **ELEMENT** MR12045P XP8
- ⑨ **BLANKING CAP(3)** MR12045P XP9

artos

MR12045P

ryton towel warmer,
plug-in

CARE & MAINTENANCE

For best results, keep the following in mind to retain the high quality finish of your artos® towel warmer:

- Use a soft, dampened sponge or cloth. On no account should you use an abrasive material such as a brush, scouring pad or steel wool to clean surfaces.
- Test your cleaning agent solution on an inconspicuous area before applying to the entire faucet.
- Wipe surfaces clean and rinse completely with water immediately after applying cleaning agent.
- An ideal cleaning technique is to rinse faucet thoroughly and blot dry any water from the surface after each use.

LIMITED WARRANTY

artos® towel warmers are guaranteed for five years against finishing defects and one year for the element as the original purchaser owns it.

Damage caused by accident, misuse, abuse, improper installation, improper cleaning or alteration will void the warranty. This warranty does not cover replacement parts where damage is caused by normal wear and tear. Westover, Inc is not responsible for labor charges, installation or other incidental or consequential costs. Proof of purchase must be provided with all claims.

Please register this product online at WWW.ARTOS.US.COM

ITEM NO. **MR12045P**
SERIAL NO.