

Features

- Cool white LED Light with Dimmable touch control
- Mirrored interior with 3 layer adjustable glass shelves
- Includes Defogger with push button
- Includes two outlet
- Includes an adjustable makeup mirror
- Includes installation hardware for recess mounting
- Can be recessed or surface mounted
(surface mounting is included)
- Interior Light with sensor switch
- Energy efficient LED lighting:

Kelvin	6500
CRI	80+
Lumens*†	810
R9 Value*	50+
Watts (AC)	60
Lumens per Watt	90

Construction

- Grey aluminum body and door frame
- 3 mirror design – rear of cabinet and both sides of door
- Concealed finger pull-door edge
- Two pieces DTC self-closing hinges for each door
Both side door open 155°, middle door open 90°
- Adjustable shelving at 2 1/3" (60 mm) increments
- Single field wire into electrical shelf - Front access serviceability

Codes/Standards Applicable

Electric Option Models are ETL certified to:

- UL 962
- CSA Standard C22.2 No. 68

Dimensions

Height: 32" (813 mm)

Width: 60" (1524mm)

Depth: 5" (127 mm) When surface mounted

1" (25 mm) When recessed

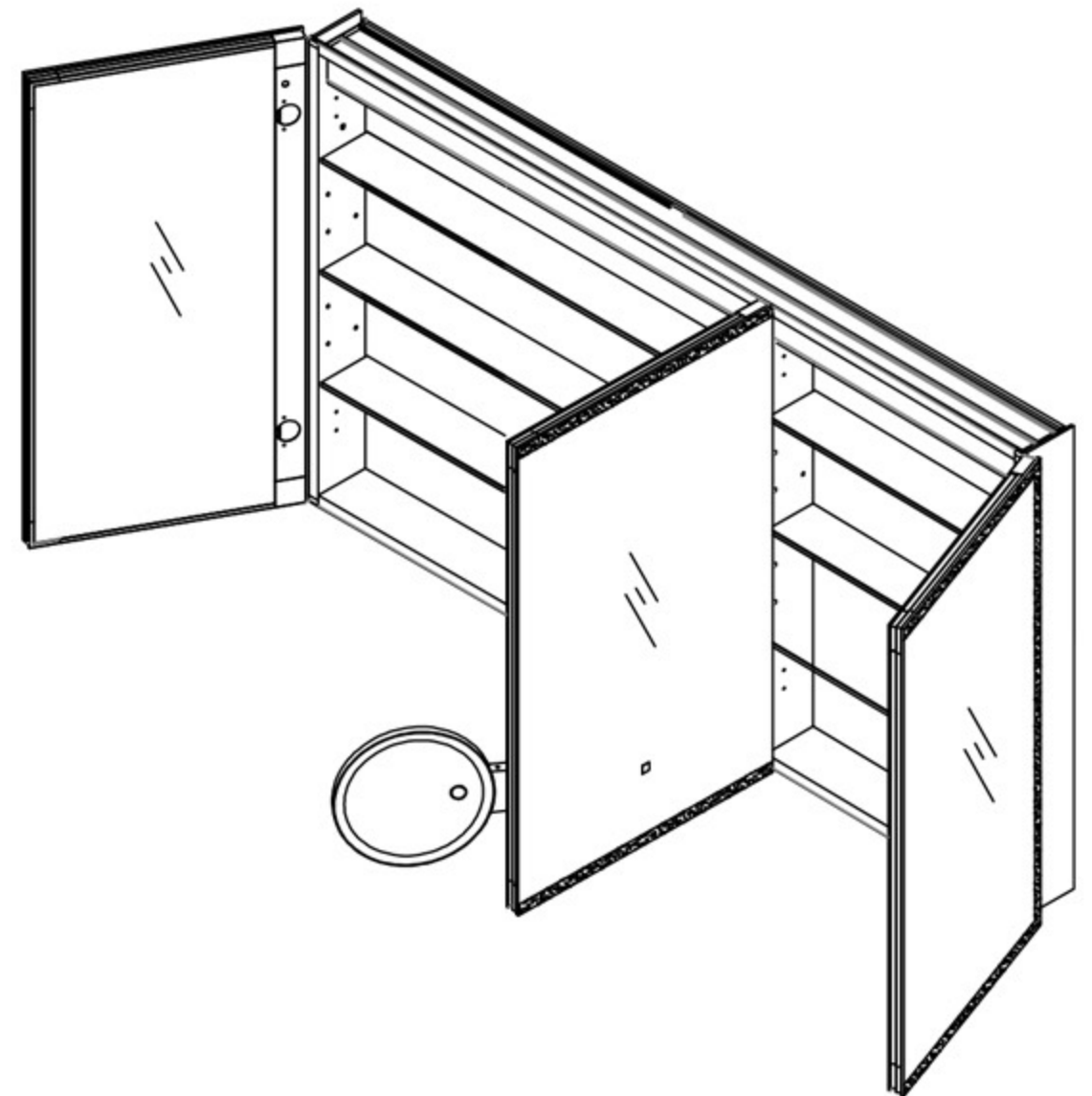
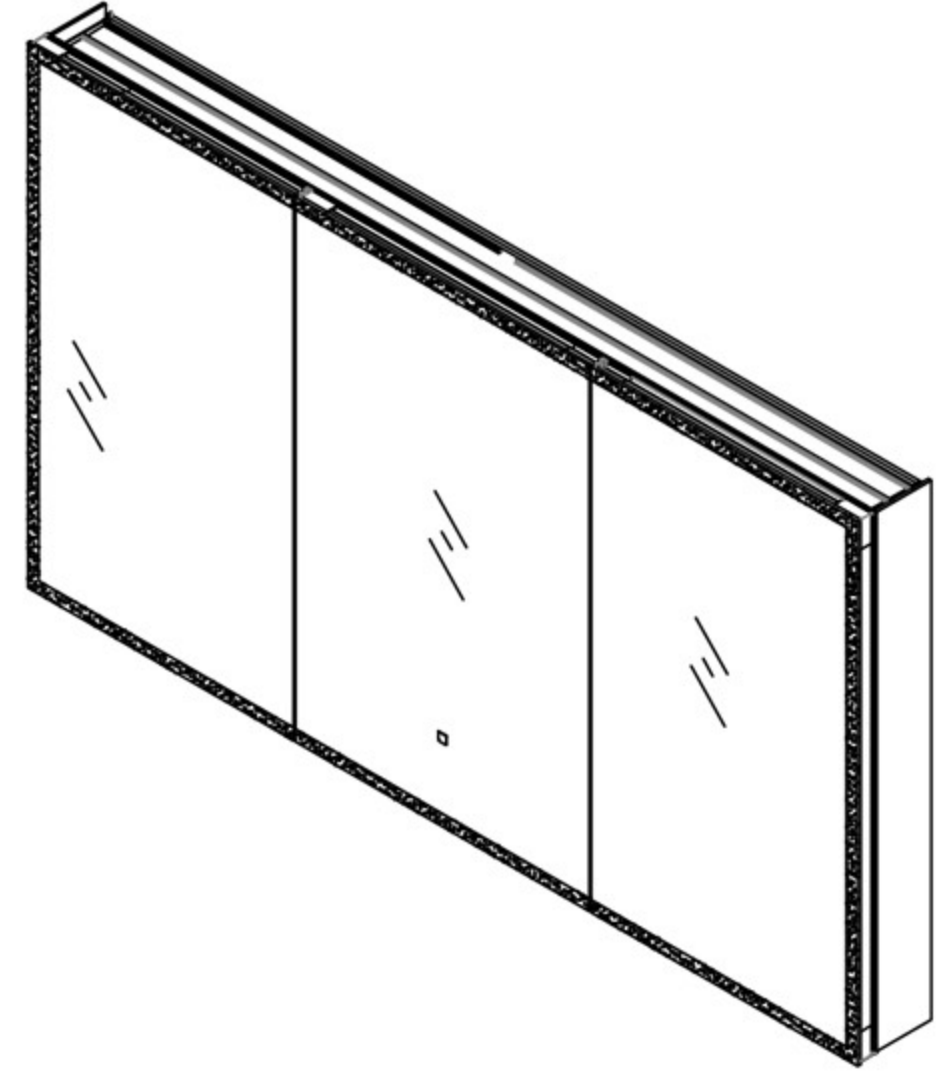

Installation Options

- Recessed Mount - Rough Opening - 31-1/3" H x 59-1/2" W x 4" D (795mm H x 1511mm W x 102mm D)
- Surface Mount - Surface Mount Kit is included

Electrical System

- 100 Watts LED Driver
- INPUT : 120VAC 60HZ 2.2A
- OUTPUT : 12VAC 8.5A
- Field wire location as shown in drawing
- 1/2" conduit (Ø 7/8" actual) electrical knockout location shown below
- Included field wire cable clamp
- Circuit Diagram

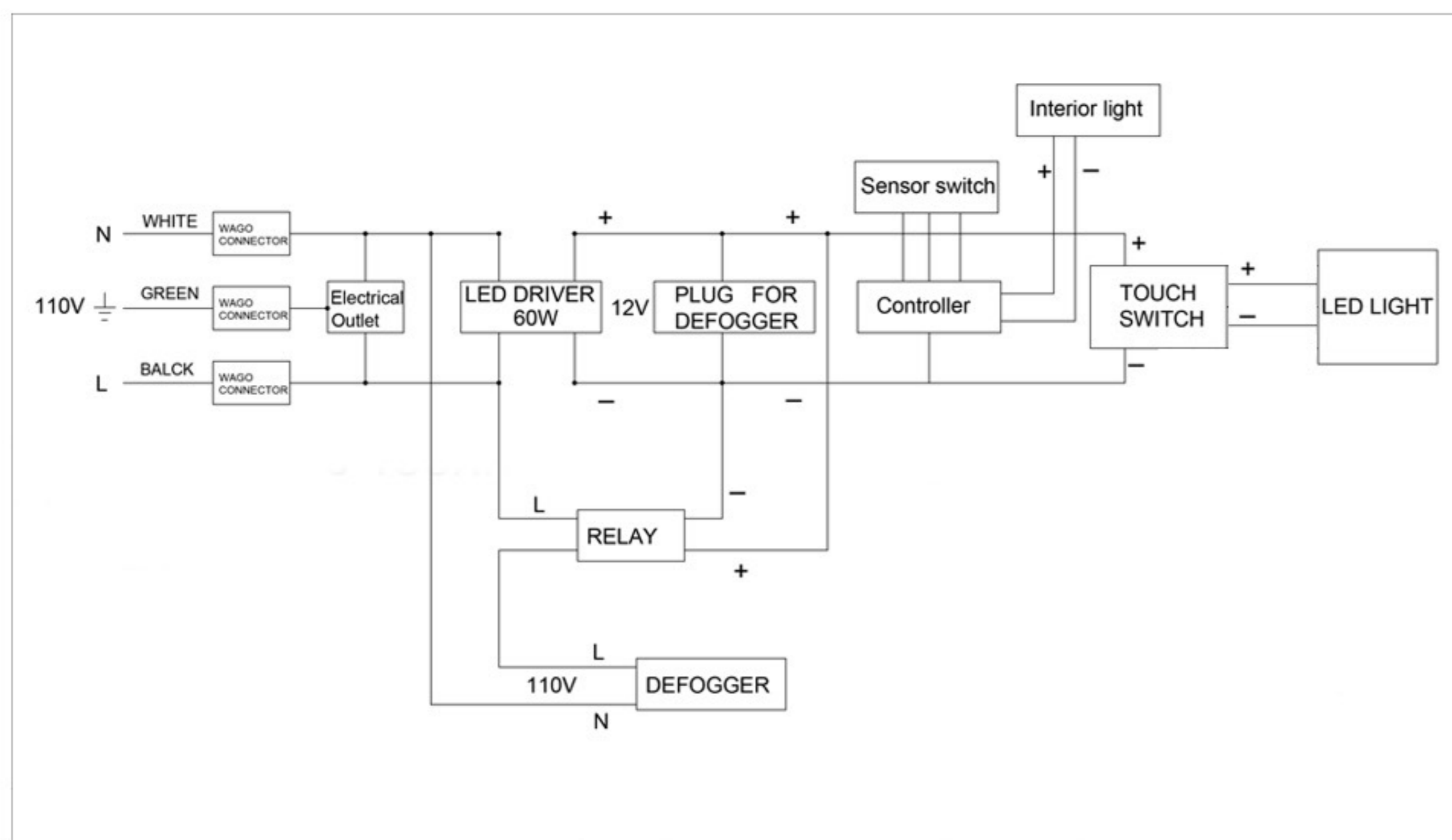

Circuit Diagram

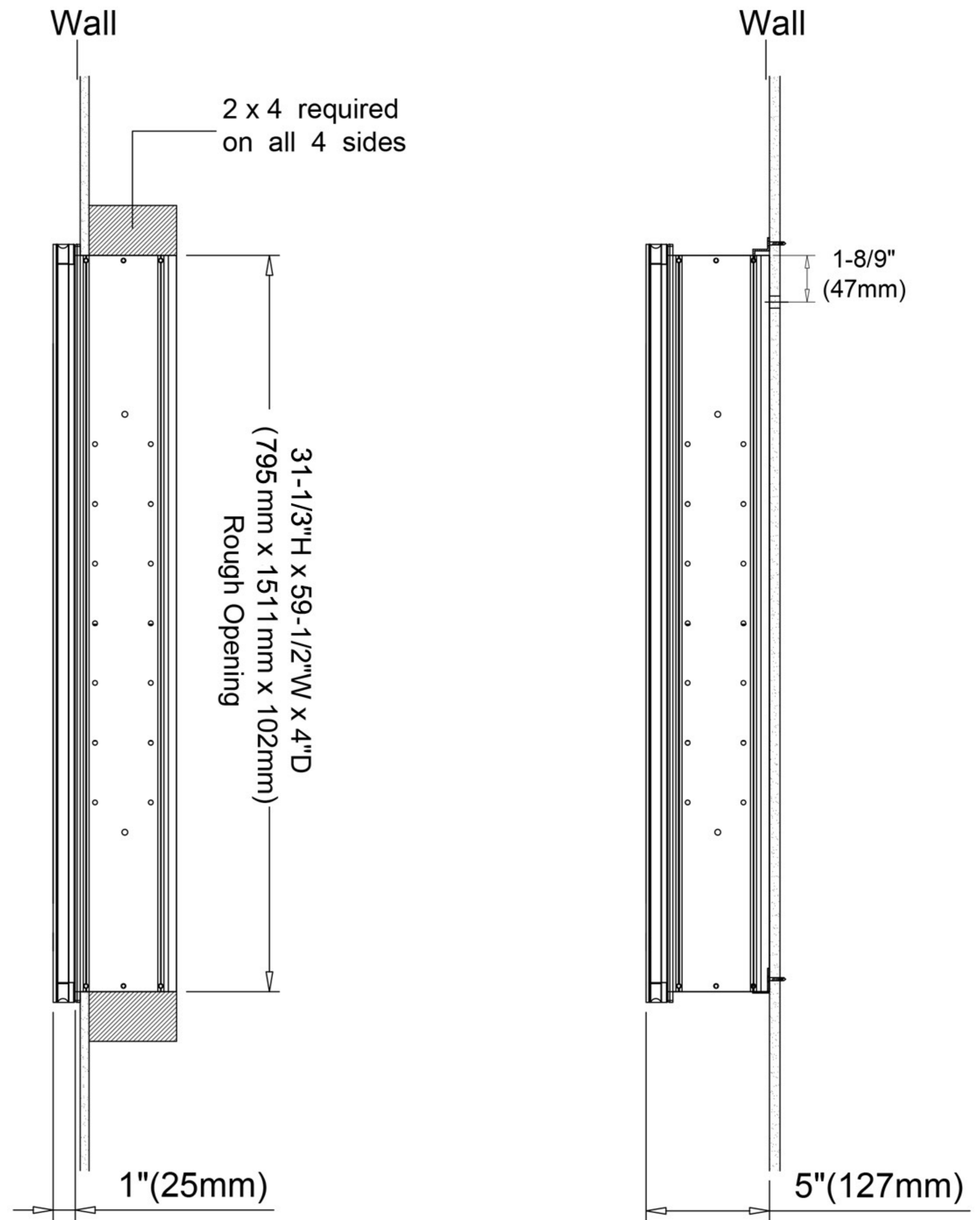

Recessed Mount

Surface Mount

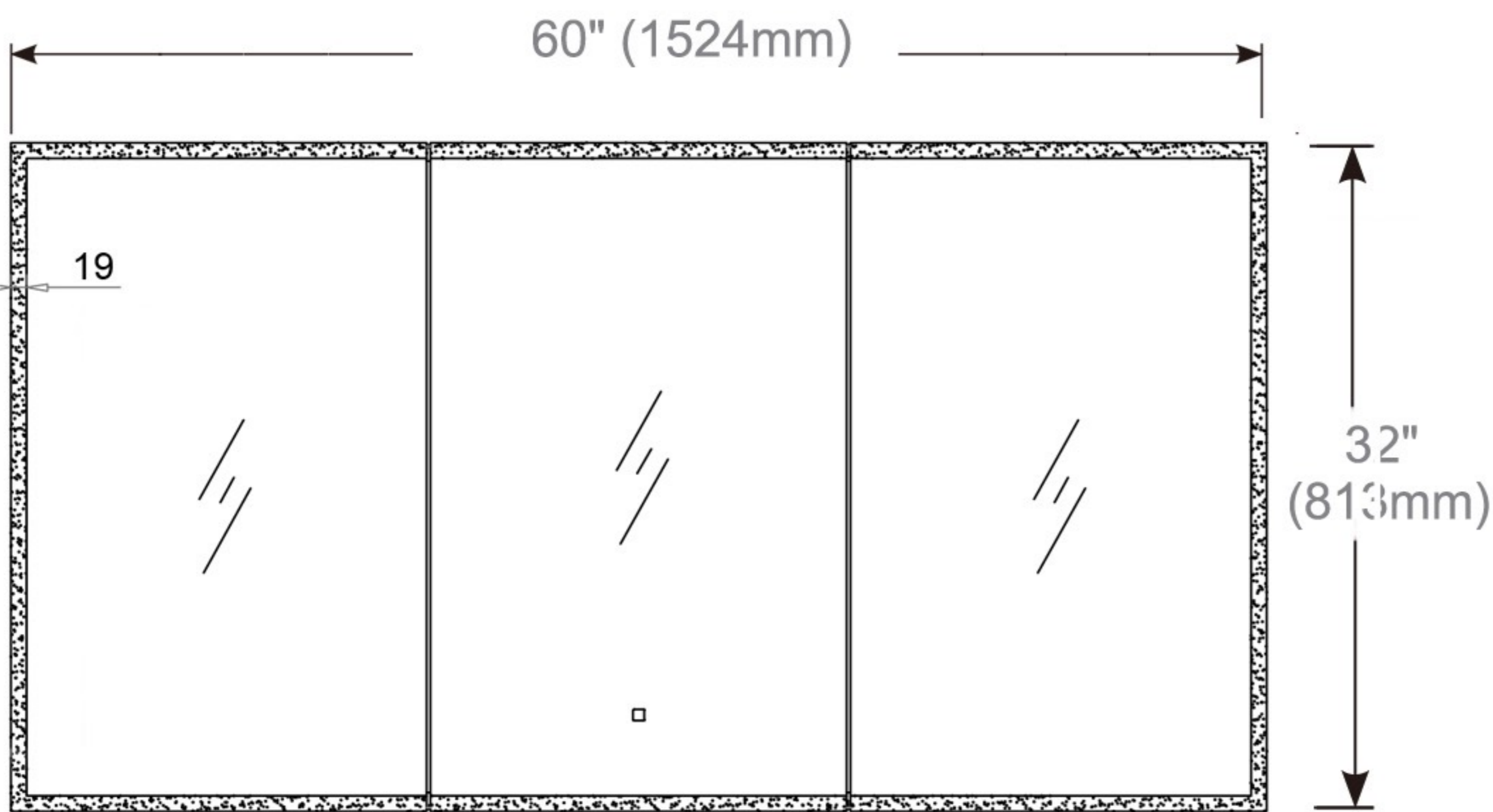

Cabinet Dimensions

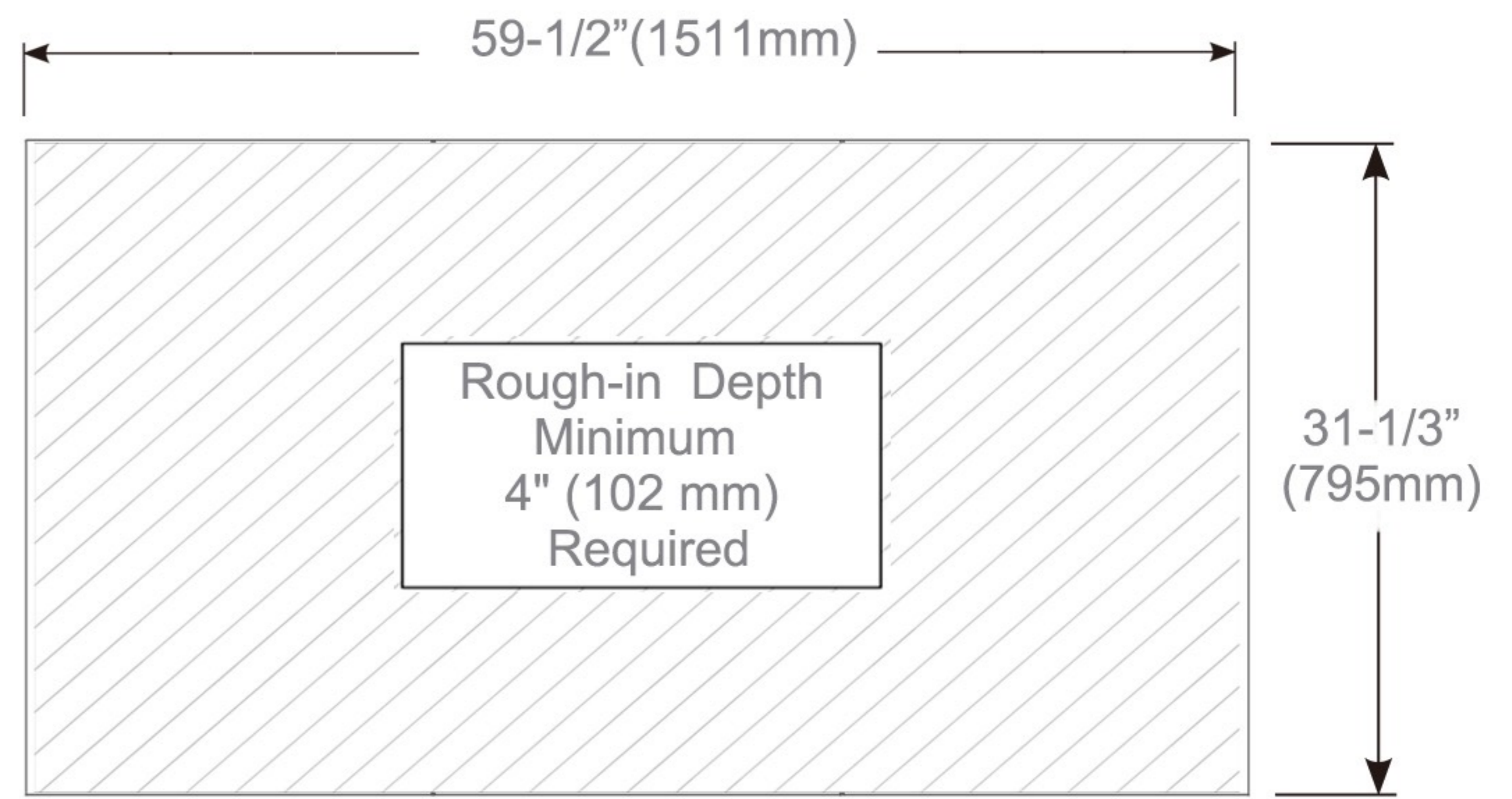

Rough-in Dimensions

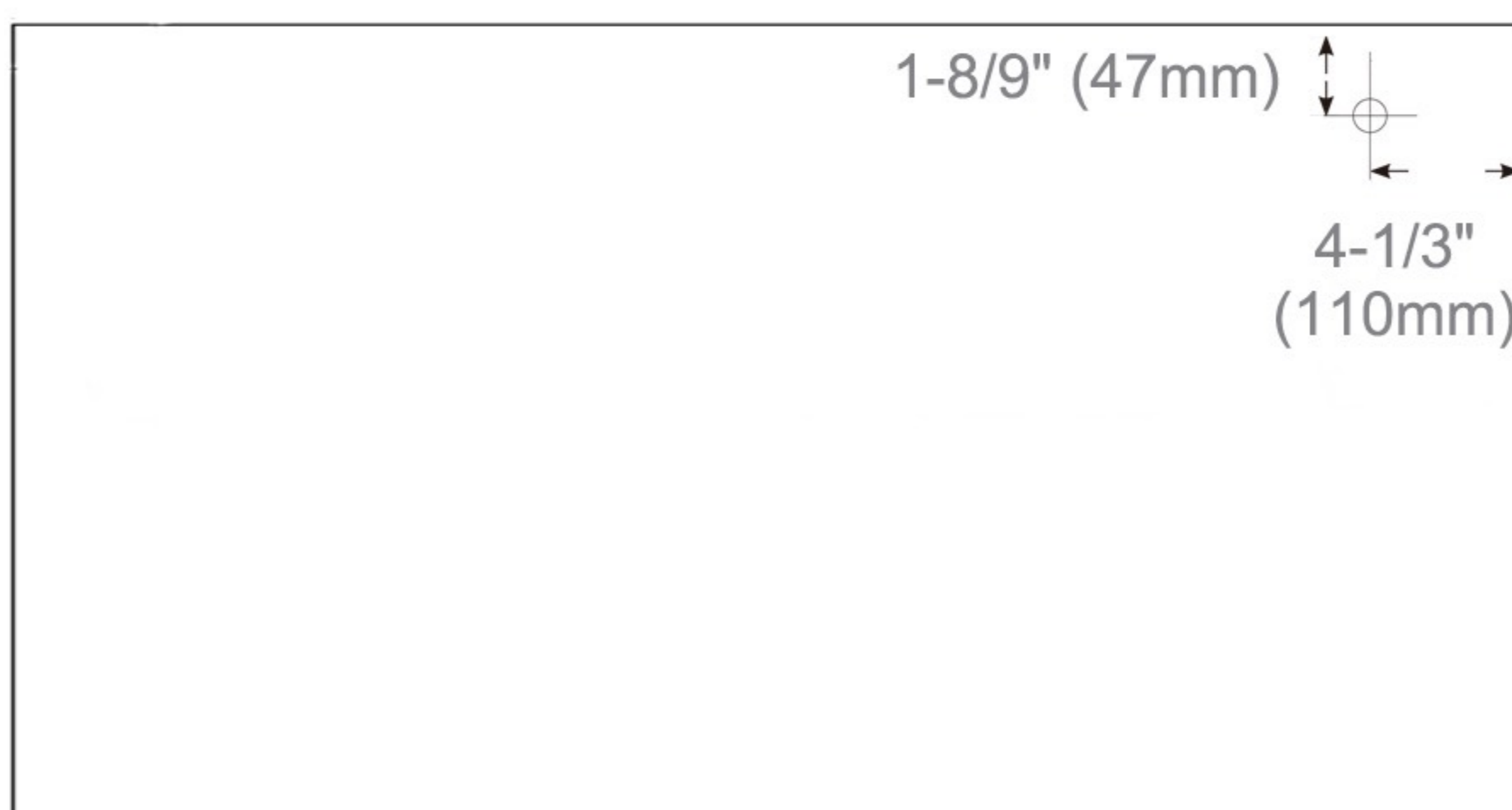

Back of Cabinet - Wire Access Location