









































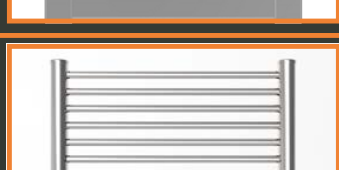



















Amba[®]

HEATED TOWEL RACKS

HEATED TOWEL RACKS

PRODUCT CATALOG 2018.8



	<p>JEEVES COLLECTION \$480-\$1,620</p>	 HARDWIRED ONLY  LF LIQUID-FILLED SYSTEM  REPLACEABLE HEATING ELEMENT  LEFT-ASSEMBLY AVAILABLE (EXTRA FEE)  10 10-YEAR LIMITED WARRANTY  REQUIRES SWITCH (NOT INCLUDED)
	<p>SIRIO COLLECTION \$780-\$1,430</p>	 HARDWIRED ONLY  DE DRY ELEMENT SYSTEM  DIGITAL HEAT CONTROLLER (INCLUDED)  LEFT-ASSEMBLY SPECIAL ORDER  3 3-YEAR LIMITED WARRANTY
	<p>QUADRO COLLECTION \$680-\$1,780</p>	 HARDWIRED ONLY  DE DRY ELEMENT SYSTEM  DIGITAL HEAT CONTROLLER (INCLUDED)  LEFT-ASSEMBLY SPECIAL ORDER  3 3-YEAR LIMITED WARRANTY
	<p>ELORY COLLECTION \$1,690-\$1,800</p>	 HARDWIRED ONLY  DE DRY ELEMENT SYSTEM  INTEGRATED DIGITAL HEAT CONTROLLER  3 3-YEAR LIMITED WARRANTY
	<p>VEGA COLLECTION \$1,600-\$2,000</p>	 HARDWIRED ONLY  DE DRY ELEMENT SYSTEM  DIGITAL HEAT CONTROLLER (INCLUDED)  LEFT-ASSEMBLY SPECIAL ORDER  3 3-YEAR LIMITED WARRANTY
	<p>ANTUS COLLECTION \$2,270-\$2,500</p>	 HARDWIRED ONLY  DE DRY ELEMENT SYSTEM  DIGITAL HEAT CONTROLLER (INCLUDED)  LEFT-ASSEMBLY SPECIAL ORDER  3 3-YEAR LIMITED WARRANTY
	<p>SOLO COLLECTION \$310-\$370</p>	 PLUG-IN ONLY  DE DRY ELEMENT SYSTEM  FREESTANDING  ADJUSTABLE HEIGHT LEGS  2 2-YEAR LIMITED WARRANTY  INTEGRATED SWITCH
	<p>SWIVEL COLLECTION \$320-\$420</p>	 PLUG-IN ONLY  DE DRY ELEMENT SYSTEM  2 2-YEAR LIMITED WARRANTY  INTEGRATED SWITCH
	<p>TRADITIONAL COLLECTION \$970-\$1,150</p>	 HARDWIRED ONLY  LF LIQUID-FILLED SYSTEM  REPLACEABLE HEATING ELEMENT  LEFT-ASSEMBLY AVAILABLE (EXTRA FEE)  3 3-YEAR LIMITED WARRANTY  REQUIRES SWITCH (NOT INCLUDED)
	<p>RADIANT COLLECTION \$310-\$550</p>	 HARDWIRED  PLUG-IN  DE DRY ELEMENT SYSTEM  2 2-YEAR LIMITED WARRANTY  INTEGRATED SWITCH

CONTENTS

CONTENTS	3
ABOUT US	4
INTRO	5
HOW IT WORKS	6
WHERE TO USE	7
CONTROLS	8
CONTROLS	9
FINISHES	10
BAR STYLES	11
JEEVES	12–19
SIRIO	20–27
QUADRO	28–35
VEGA	36–41
ELORY	42–47
ANTUS	48–53
SOLO	54–57
SWIVEL	58–61
TRADITIONAL	62–65
RADIANT	66–69
TERMS OF SALE	70
WARRANTY	71

FOR INSTALLATION GUIDES AND TECHNICAL
DRAWINGS PLEASE VISIT OUR WEBSITE:
www.ambaproducts.com

ABOUT US



We are an American company proud to be one of the first to introduce stylish, affordable high end Heated Towel Racks made of the highest quality stainless steel in a variety of finishes. We serve retailers and customers throughout the United States, Canada, Mexico and the Caribbean.

We are constantly bringing innovative designs and heating technology to the forefront of our offerings which appeal to interior designers, architects and clients around the world.

Amba's exclusive product ranges are designed with residential and commercial customers in mind. We offer a variety of over 150+ Heated Towel Rack models, all in stock for quick delivery throughout North America. For those with specific needs we offer a range of special order sizes to fit any project.

Our Heated Towel Rack collections provide efficient heat while using minimal energy – consuming only as much energy as one or a few light bulbs. Various methods of heat control are available.

By making sure your towels stay warm and dry after use, the towel rack prevents mold & mildew from forming. This eliminates the gross, musty smell and enables you to reuse your towels and bathrobes more often therefore reducing trips to the laundry. Reducing laundry loads saves on water, energy, detergent and time.

Safety is always a top concern for us at Amba – our Heated Towel Racks meet stringent safety standards for the US and Canada. Our products are backed by extensive warranty coverage.

When it comes to customer service Amba is unmatched – We see it as our duty to support our clients and to respond swiftly to customer needs. We make sure that if you call you'll speak to a real and knowledgeable person! (No call centers here!) We are also available to answer your questions via our website contact form or through our company pages on Facebook, Twitter, Houzz, or LinkedIn.

FAST SHIPPING | 304-GRADE STAINLESS STEEL | ALL PRODUCTS CERTIFIED UL/ETL APPROVED | SAME PRICE ANY FINISH

VISIT OUR WEBSITE FOR:

FAQS | Technical Drawings | Installation Guides

www.ambaproducts.com

WHAT ARE HEATED TOWEL RACKS

Heated Towel Racks are known by many names: Heated Towel Bars, Towel Warmers, or Drying Racks – essentially all Heated Towel Racks fulfill similar functions:

DRY WET OR DAMP TOWELS

PROVIDE DRY TOWELS WITH ADDITIONAL WARMTH

ACT AS A SOURCE OF HEAT FOR A BATHROOM

NOT ALL HEATED TOWEL RACKS ARE CREATED EQUAL:

There are a few factors which dictate how well a particular Heated Towel Rack performs, most notably the output of it's element, and the surface area. Some models may be effective at drying towels, but may not act as a heat source.

To better understand the effectiveness of our wide range of models, it makes sense to classify them into three categories:

DRYING RACKS

These models will offer a stylish place to hang towels and to keep them dry – but usually contain lower-output heating elements or fewer bars which means that they will not be as effective at heating towels as other models.

Swivel Collection
Smaller Jeeves Models
{ H / I / J / F }



HEATED TOWEL RACKS

Heated Towel Racks can be considered the 'standard' models if one is looking to both dry and warm towels. Individual heating ability will depend on output and surface area, but most units will keep towels comfortably warm.

Jeeves Collection
Mid-Sized Quadro / Sirio
Solo Collection
Traditional Collection
Radiant Collection



DUAL-FUNCTION RACKS

These models contain higher output heating capacity and are usually much larger than standard Heated Towel Racks. At these output levels it is common to find digital heat controllers included for better control – as at higher settings these units can provide small spaces with a source of heat.

Large Quadro / Sirio
Elory Collection
Vega Collection
Antus Collection



HOW DO HEATED TOWEL RACKS WORK

LF LIQUID-FILLED SYSTEM:

These Heated Towel Racks contain a water/glycol mixture that is heated by a rod-like heating element running along one of the vertical bars. The warmer liquid rises as it heats up until the entire Heated Towel Rack reaches it's maximum temperature. This technology will take longer to heat than a dry-element system, but is a more energy efficient system.

DE DRY-ELEMENT SYSTEM:

Also known as 'cable-heated' systems, these Heated Towel Racks have resistance wire inside each bar that heat up, transferring warmth into the bars and across the whole unit. They heat up quickly and evenly, and typically have on/off switches integrated into the design.

LIQUID-FILLED COLLECTIONS:
JEEVES | TRADITIONAL

DRY-ELEMENT COLLECTIONS:
SIRIO | QUADRO | ELORY | VEGA | ANTUS | SOLO | SWIVEL | RADIANT

HYDRONIC UNITS

Not to be confused with liquid-filled models, hydronic units connect to existing closed-loop hot water systems to heat themselves up. This is the same way traditional 'radiators' function – there is no electrical connection to heat the bars. The heat output of hydronic units are going to depend on how hot you have your water heater set. These units will require a valve kit to attach to the closed-loop water system, sold separately.

Hydronic models are available for most Collections as a special order item:
[See individual Collection pages for information and availability.](#)



HOW LONG DO THEY TAKE TO WARM UP?

As your Heated Towel Rack warms up it starts to transfer that heat to the towel – how long this process takes will depend on the maximum heat output, as well as how many bars are in contact with the hanging towel, and finally the ambient temperature where it is installed. Our Heated Towel Racks are all designed and built to be left on 24 hours a day, though some users may choose to install one with a programmable timer or a countdown switch. When using a separate timer, please allow sufficient time for the unit to reach its operating temperature and warm your towel when setting the program.



WHAT ARE THEY MADE OF?

The majority of our Heated Towel Racks are made with the finest 304-grade stainless-steel – this high-quality metal is more resistant to corrosion, perfect for the moisture-filled conditions in which you usually find Heated Towel Racks. If cleaned and maintained properly, our models can remain pristine for many years.

Traditional Collection models are made with high-quality mild steel.

WHAT IS THE BEST WAY TO HANG TOWELS?

To get the most out of a Heated Towel Rack, you want to make sure you fold your towels to maximize the surface area that will be in contact with the bars. The way you fold and hang your towel will depend on the configuration and size of your Heated Towel Rack, as well as the style and thickness of your towel. For a typical 2-towel set up on a ~20" wide model, the best method to maximize efficiency is to fold towels in half width-wise, and then hang them over the top bar side-by-side, so that the bars are 'sandwiched' between the inside folds. By hanging your towels like this you trap heat which helps maintain the temperature and speeds up the transfer rate.

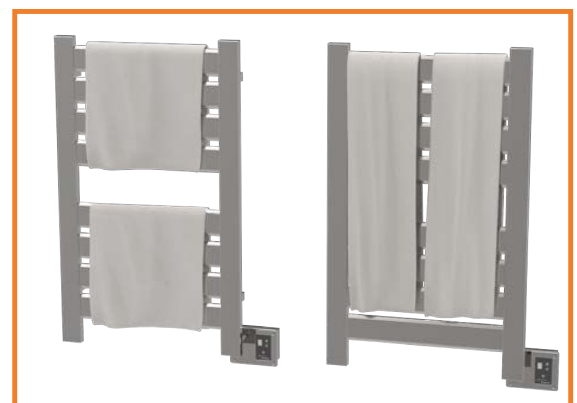

TWO EXAMPLES OF HOW TO HANG TOWELS EFFICIENTLY

WHERE TO USE

Any room or area where you are likely to use a towel can benefit from the function and style of one of our Heated Towel Racks! For safety we always recommend consulting a certified electrician when installing our products to make sure that local electrical code is adhered to.

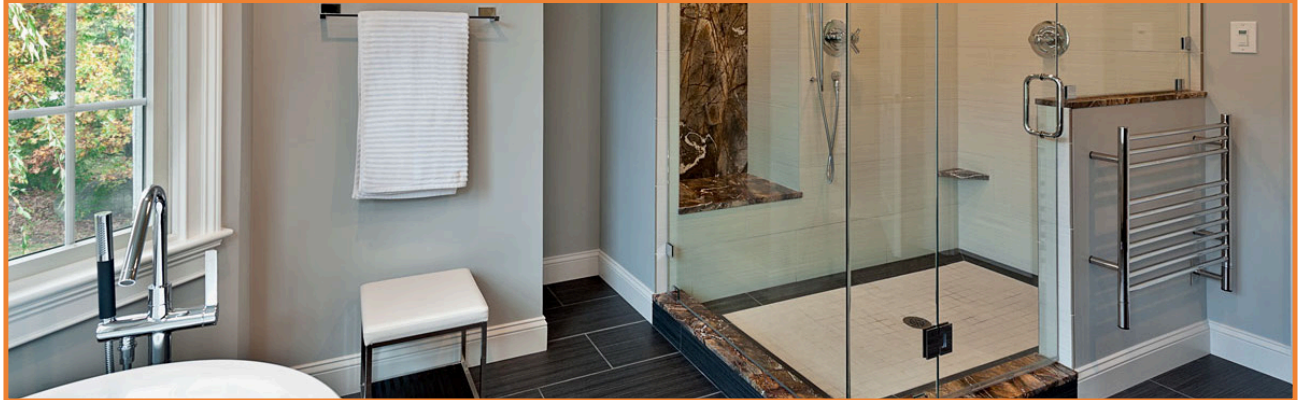

BATHROOMS

Heated Towel Racks replace your standard towel bars and provide your bathroom with a stylish and functional upgrade – Step out of your shower into a dry, warm towel! Hang up your wet towels and rest assured that they will dry off quickly and efficiently, saving your bathrooms from that damp, moldy smell while reducing need to wash towels as frequently! Larger Heated Towel Racks can even function as space heaters for colder bathrooms, helping to reduce humidity. There are other areas of the home that can benefit from a Heated Towel Rack:

LAUNDRY ROOMS

Heated Towel Racks can safely dry more delicate items – some models include a digital heat controller for precise heat control.

MUD ROOMS

Welcome wet clothing with a nice Heated Towel Rack and make sure that they have a place to dry off completely, saving a trip to the laundry hamper!

BASEMENTS / GARAGES

Larger, higher output Heated Towel Racks can help keep some places dry and warm, while providing hanging space for towels or other clothing.

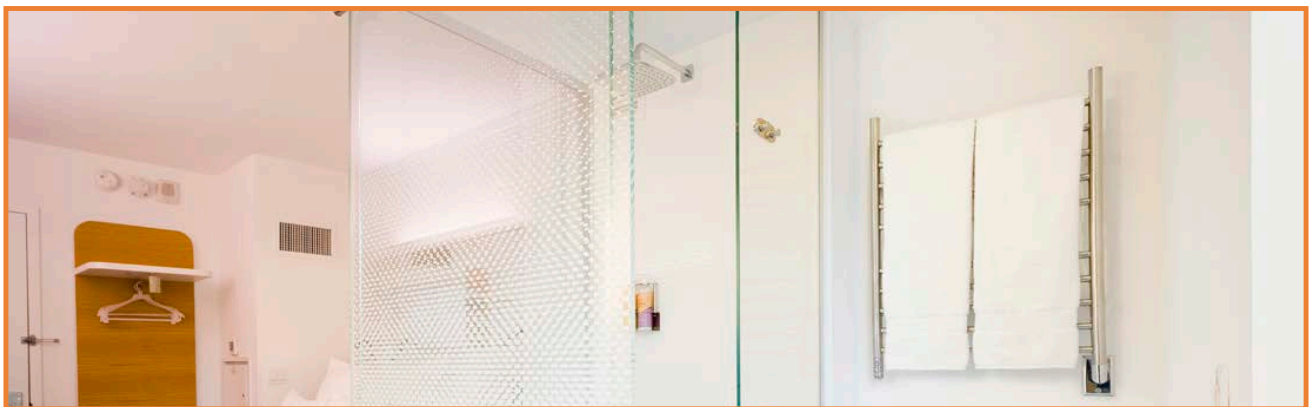

HOTELS

Heated Towel Racks are an incredible luxury and major asset to any hotel bathroom – especially bathrooms with little to no ventilation for air-drying. Guests can enjoy the comfort of a dry, warm towel while benefiting the hotel and environment! By incentivizing guests to reuse their towels with our Heated Towel Racks, less towels need to be washed on a daily basis –reducing water, energy, and soap used in laundry service. No need to sacrifice guest comfort in the name of sustainability when they happily reuse their dry, warm towels off of a Heated Towel Rack!

POOLS & SPAS

Keep towels dry and warm, ready for a pool day or spa-like experience wherever they are needed.

BOATS & YACHTS

Heated Towel Racks can even be included on boats or yachts to bring their style and functionality on board.

CONTROLS

There are many ways to control your Heated Towel Rack: Turn your Heated Towel Rack on and off, or control when and for how long it stays on for with our range of control accessories. Even if your model features an integrated switch, these extra controls can help optimize your usage or add extra convenience. Controllers on this page are sold separately.



DOES NOT INCLUDE COVER PLATE

PROGRAMMABLE TIMER

SKU	ATW-T24 ATW-T24-BL*
LIST PRICE	US \$60*

HARDWIRED ONLY
5 YEAR LIMITED WARRANTY

7 DAY / 24 HOUR PROGRAMMABLE TIMERS

Program your Heated Towel Rack to turn on and off based on your schedule. Recommended for those with regular routines looking to automate their bathroom routine.

We recommend using these timers to have your Heated Towel Rack turn on roughly 1–2 hours before you intend to use your towel, so that it has enough time to get to its operating temperature, and additional time for that heat to transfer to the towel. You then want to program it to turn off a few [2-3] hours after you have used your towel, so it has plenty of time to dry completely.

Both the Hardwired and Plug-In Programmable Timers work the same way and can be set to manual mode, making them operate like a standard on/off switch.

Hardwired Timer comes standard with Light Almond / Ivory / White control panel cover.

*Color Conversion Kit for Black switch available at additional cost [\$10]



PLUG-IN PROGRAMMABLE TIMER

SKU	ATW-P24
LIST PRICE	US \$40

PLUG-IN ONLY
5 YEAR LIMITED WARRANTY



DOES NOT INCLUDE COVER PLATE

COUNTDOWN TIMER

SKU	ATW-CDT ATW-CDT-BL*
LIST PRICE	US \$60*

HARDWIRED ONLY
5 YEAR LIMITED WARRANTY

COUNTDOWN TIMER COMPATIBLE WITH HARDWIRED MODELS

Turn your Heated Towel Rack on for a specific amount of time: 2, 4, 8, or 12 hours – great for those who do not want to leave their units on continuously, but also do not want to limit usage to a specific schedule like with the Programmable Timers.

Hit the desired duration to power on your Heated Towel Rack then give it enough time to reach its operating temperature and transfer heat to the towel. The Countdown Timer will then turn off the unit after the designated amount of time has passed. The unmarked button operates as a standard on/off switch.

Comes standard with Light Almond / Ivory / White control panel cover.

*Color Conversion Kit for Black switch available at additional cost [\$10]

PILOT LIGHT SWITCH COMPATIBLE WITH HARDWIRED MODELS

A large on/off switch with indicator light – be able to tell if your Heated Towel Rack is on at a glance. This control pairs well with Jeeves Collection models, which do not have integrated switches.

For Heated Towel Racks with integrated switches, a supplemental Pilot Light Switch can be installed where desired for added convenience – for example: directly next to bathroom light switches for easy access.

Available in Almond / White



DOES NOT INCLUDE COVER PLATE

SKU	ATW-S-A ATW-S-W
LIST PRICE	US \$30

HARDWIRED ONLY
5 YEAR LIMITED WARRANTY

DIGITAL HEAT CONTROLLER



DIGITAL HEAT CONTROLLER

Just like the name implies, these controllers allow control of heat with nine different settings. It also functions as a standard on/off switch. Adjust the heat level with a push of a button allowing for flexible use of your Heated Towel Rack under any condition! Turn down the heat to hang and warm items like bathrobes or delicates like silk. While we highly recommend using the Digital Heat Controller with all included models, it is possible to use a standard single gang box push-button switch instead. (sold separately).

Left-assembly units with the Digital Heat Controller are available by special order for compatible models. The orientation of the DHC, however, does not change.

COMES STANDARD WITH THE FOLLOWING COLLECTIONS:

SIRIO* | **QUADRO*** | **VEGA** | **ANTUS** | **ELORY**
 [INTEGRATED]

**Not included with Quadro Q2016 or the Sirio S2121*

THE DIGITAL HEAT CONTROLLER IS NOT COMPATIBLE WITH:
JEEVES | **SOLO** | **SWIVEL** | **TRADITIONAL** | **RADIANT**



REMOTELY WIRED DIGITAL HEAT CONTROLLER

This optional Digital Heat Controller can be installed anywhere along the hardwired circuit, allowing it to be placed in more convenient locations, even across the room, and not just immediately behind the Heated Towel Rack. This replaces the standard Digital Heat Controller with a single gang box as shown the example. A single controller can be wired to multiple Heated Towel Racks if desired.

This does NOT allow for remote control of the unit, but rather for it to be wired independent of the Heated Towel Rack itself.

DIGITAL HEAT CONTROLLER [Hardwired] *

S.K.U	FINISH	WATTS	AMPS	LIST PRICE
ATW-DHC-P	Polished	1200	10	\$300
ATW-DHC-B	Brushed	1200	10	\$300
ATW-DHC-O	Oil-Rubbed Bronze	1200	10	\$300
ATW-DHC-W	White	1200	10	\$300
ATW-DHC-MB	Matte Black	1200	10	\$300
ATW-DHC-SB	Satin Brass	1200	10	\$300

DIGITAL HEAT CONTROLLER [Remotely Wired] *

S.K.U	FINISH	WATTS	AMPS	LIST PRICE
ATW-DHCR-P	Polished	1200	10	\$300
ATW-DHCR-B	Brushed	1200	10	\$300
ATW-DHCR-O	Oil-Rubbed Bronze	1200	10	\$300
ATW-DHCR-W	White	1200	10	\$300
ATW-DHCR-MB	Matte Black	1200	10	\$300
ATW-DHCR-SB	Satin Brass	1200	10	\$300

BOTH THE DIGITAL HEAT CONTROLLER AND REMOTELY WIRED DIGITAL HEAT CONTROLLER CAN BE WIRED WITH TIMERS FOR ADDED CONTROL.

FINISHES

We offer a wide range of finishes for each of our Heated Towel Rack Collections to accompany any style. Finish availability will depend on the Collection – though we do offer some finishes as special order options.

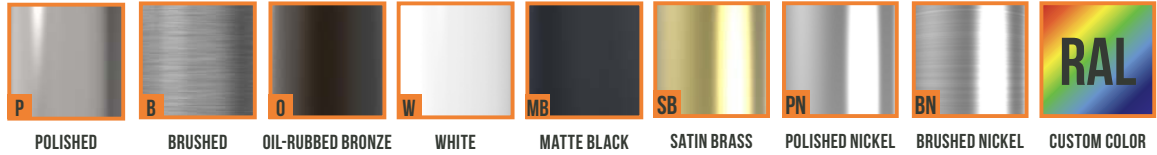

	P	B	O	W	MB	SB	PN	BN	RAL
	POLISHED	BRUSHED	OIL-RUBBED BRONZE	WHITE	MATTE BLACK	SATIN BRASS	POLISHED NICKEL	BRUSHED NICKEL	CUSTOM COLOR
JEEVES	✓	✓	✓	✓	✓				
QUADRO	✓	✓	✓+	✓+	✓	✓+			✓+
SIRIO	✓	✓	✓	✓+	✓+	✓			✓+
ELORY	✓	✓	✓+	✓+	✓+	✓+			✓+
VEGA	✓	✓	✓+	✓	✓	✓+			✓+
ANTUS	✓	✓							
SOLO	✓	✓							
SWIVEL	✓	✓							
TRADITIONAL							✓	✓	
RADIANT	✓	✓							

✓ STOCKED ITEM

✓+ SPECIAL ORDER FINISH
12–16 Weeks lead Time

CUSTOM COLORS AND PVD FINISH –
PRICES AND AVAILABILITY ON REQUEST



MATTE BLACK

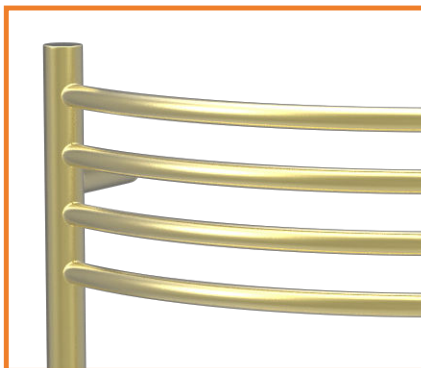

SATIN BRASS



WHITE

BAR STYLES



CYLINDRICAL BARS – JEEVES / ANTUS
RADIANT / SOLO

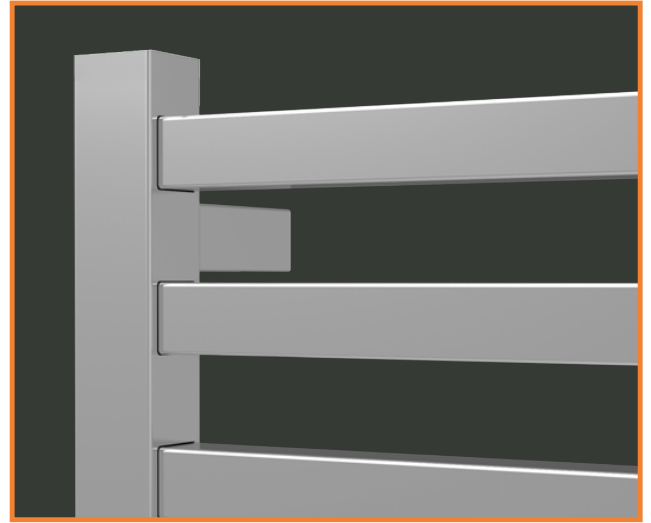

SQUARE BARS – QUADRO / RADIANT



PANEL BARS – VEGA

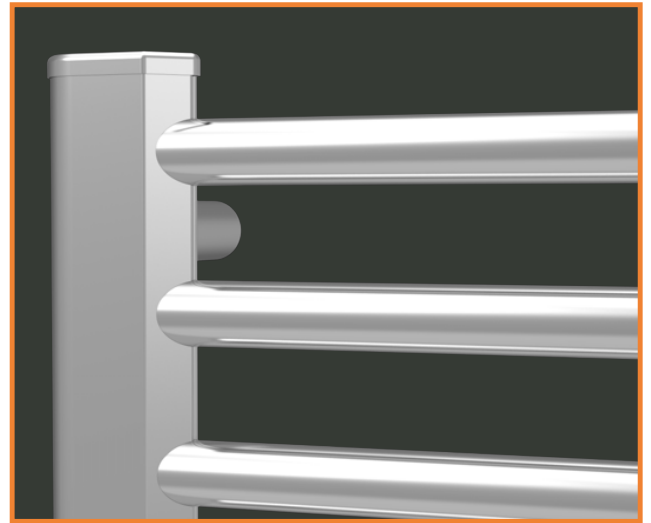

CHAMFERED-EDGE BARS – SIRIO

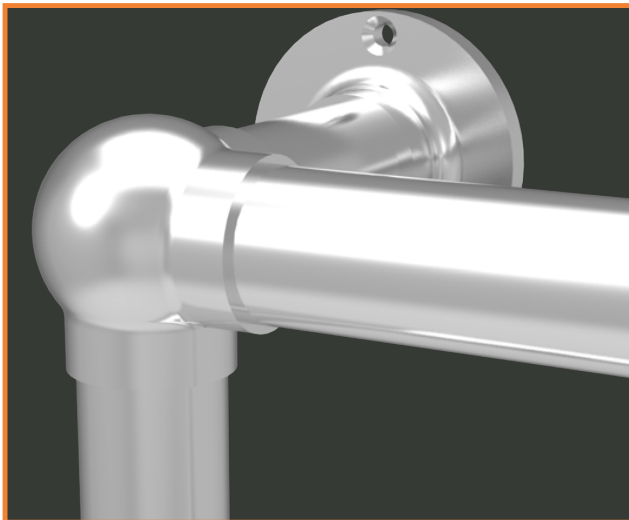

TRADITIONAL

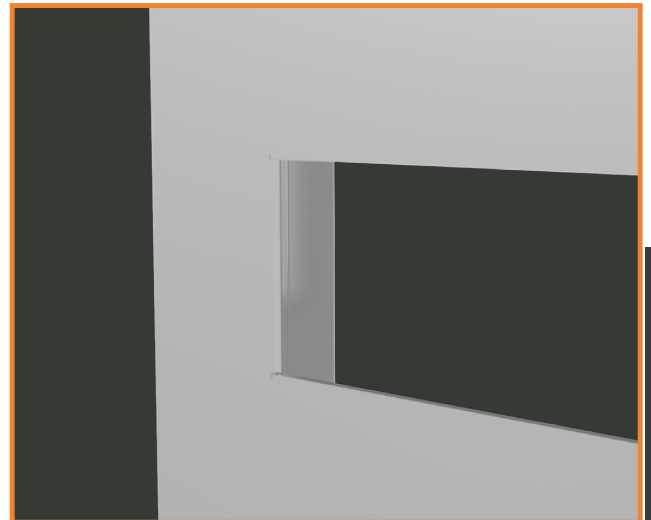

FULL-PANEL – ELORY



JEEVES COLLECTION



HARDWIRED ONLY



LIQUID-FILLED SYSTEM

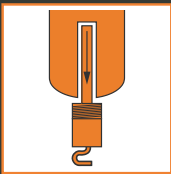

REPLACEABLE HEATING ELEMENT



LEFT-ASSEMBLY AVAILABLE (EXTRA FEE)



10-YEAR LIMITED WARRANTY

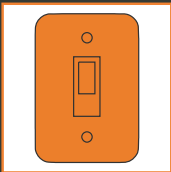

REQUIRES SWITCH (NOT INCLUDED)



ECP
MODEL E CURVED
POLISHED



FSP
MODEL F STRAIGHT
POLISHED



HSB
MODEL H STRAIGHT
BRUSHED

The Jeeves Collection is our flagship Heated Towel Rack – a timeless hardwired towel warmer design that is efficient, reliable, and long-lasting. These liquid-filled towel racks can easily accommodate large towels, and make the perfect addition to any style of bathroom. All Jeeves models self-regulate to maintain the ideal internal temperature while reducing power consumption. These are hardwired units and have a replaceable heating element.

110 VOLT
STANDARD VOLTAGE

145°F–154°F
AVERAGE TEMP RANGE

15–45M
WARM-UP TIME

**304-GRADE
STAINLESS STEEL**

ADDITIONAL SIZES
SEE SPECIAL ORDER SECTION

JEEVES COLLECTION



	MODEL H	MODEL E	MODEL C	MODEL D	MODEL I	MODEL J	MODEL F	MODEL L	MODEL K	MODEL M
	WIDTH	HEIGHT	DEPTH	WATTAGE	AMPS	BTUS	BARS	TOWELS		
MODEL H	21 1/4"	18 3/4"	4 1/2" or 6 1/2"	60-80	0.5-0.75	273	7	1-2		
MODEL E	21 1/4"	31 3/4"	4 1/2" or 6 1/2"	150-175	1.35-1.6	597	12	2-4		
MODEL C	21 1/4"	36 3/4"	4 1/2" or 6 1/2"	150-175	1.35-1.6	597	13	2-4		
MODEL D	21 1/4"	53 3/4"	4 1/2" or 6 1/2"	240	2.2	818	20	2-6		
MODEL I	21 1/4"	31 3/4"	4 1/2"	60-80	0.5-0.75	273	4	1-2		
MODEL J	21 1/4"	31 3/4"	4 1/2"	60-80	0.5-0.75	273	6	1-2		
MODEL F	21 1/4"	41 3/4"	4 1/2"	135	1.25	460	7	1-2		
MODEL K	30 1/4"	27 3/4"	4 1/2"	150-175	1.35-1.6	597	10	2-4		
MODEL L	40 1/4"	27 3/4"	4 1/2"	200	1.8	682	10	2-4		
MODEL M (SHELF)	21 1/4"	22 3/4"	15 1/4"	135	1.25	460	11	2-3		

FINISHES



POLISHED

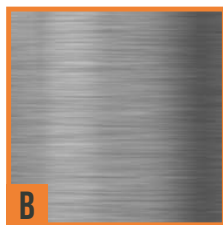

BRUSHED

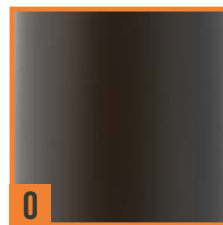

OIL-RUBBED BRONZE



WHITE



MATTE BLACK

MODEL SKU

Each of the Jeeves Collection models SKU reflects the model, whether the bars are curved or straight, and finish.

STOCKED ITEMS:

SAME PRICE ANY FINISH
SHIPS IN 1-2 DAYS (USA)

MODEL: **D C B**
MODEL D

BAR STYLE:
CURVED

FINISH:
BRUSHED

JEEVES COLLECTION

STOCKED ITEMS



STRAIGHT
US \$480



CURVED
US \$540

MODEL H

STRAIGHT:	HSP HSB HSO HSW HSMB
CURVED:	HCP HCB HCO HCW HCMB
BARS	7
WIDTH	21 1/4"
HEIGHT	18 3/4"
ELECTRICAL	60-80 watts 0.5-0.75 amps
BTUS	273



STRAIGHT
US \$970



CURVED
US \$1,070

MODEL E

STRAIGHT:	ESP ESB ESO ESW ESMB
CURVED:	ECP ECB ECO ECW ECMB
BARS	12
WIDTH	21 1/4"
HEIGHT	31 3/4"
ELECTRICAL	150-175 watts 1.35-1.6 amps
BTUS	597



STRAIGHT
US \$1,460

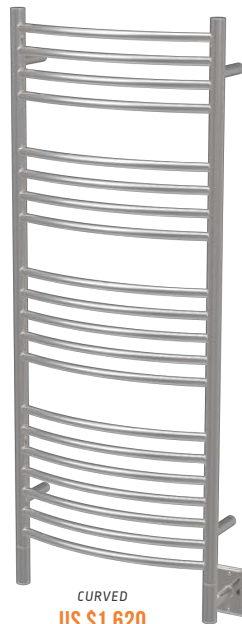

CURVED
US \$1,620

MODEL D

STRAIGHT:	DSP DSB DSO DSW DSMB
CURVED:	DCP DCB DCO DCW DCMB
BARS	20
WIDTH	21 1/4"
HEIGHT	53 3/4"
ELECTRICAL	240 watts 2.2 amps
BTUS	818

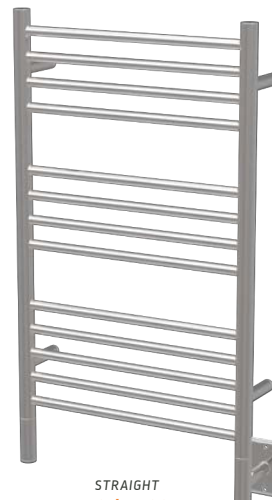

STRAIGHT
US \$1,190



CURVED
US \$1,280

MODEL C

STRAIGHT:	CSP CSB CSO CSW CSMB
CURVED:	CCP CCB CCO CCW CCMB
BARS	13
WIDTH	21 1/4"
HEIGHT	36 3/4"
ELECTRICAL	150-175 watts 1.35-1.6 amps
BTUS	597

JEEVES COLLECTION

STOCKED ITEMS



US \$1,100

MODEL K

SKU	KSP KSB KSO KSW KSMB
BARS	10
WIDTH	30 1/4"
HEIGHT	27 3/4"
ELECTRICAL	150-175 watts 1.36-1.6 amps
BTUS	597

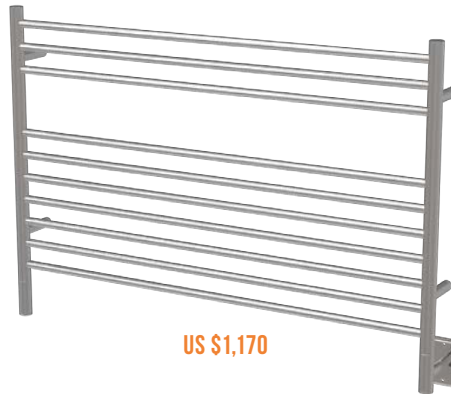

US \$1,170

MODEL L

SKU	LSP LSB LSO LSW LSMB
BARS	10
WIDTH	40 1/4"
HEIGHT	27 3/4"
ELECTRICAL	200 watts 1.8 amps
BTUS	682



US \$1,080

MODEL M SHELF

SKU	MSP MSB MSO MSW MSMB
BARS	11
WIDTH	21 1/4"
HEIGHT	22 3/4"
DEPTH	15 1/4"
ELECTRICAL	150-175 watts 1.35-1.6 amps
BTUS	460

DRYING RACKS

Models I / J / F contain lower-output elements and have less bars, making them less efficient than other models in the Jeeves Collection. We consider these "Drying Racks" and might not be suitable for 'warming' towels.



US \$590

MODEL I

SKU	ISP ISB ISO ISW ISMB
BARS	4
WIDTH	21 1/4"
HEIGHT	31 3/4"
ELECTRICAL	60-80 watts 0.5-0.75 amps
BTUS	273



US \$730

MODEL J

SKU	JSP JSB JSO JSW JSMB
BARS	6
WIDTH	21 1/4"
HEIGHT	31 3/4"
ELECTRICAL	60-80 watts 0.5-0.75 amps
BTUS	273



US \$810

MODEL F

SKU	FSP FSB FSO FSW FSMB
BARS	7
WIDTH	21 1/4"
HEIGHT	41 3/4"
ELECTRICAL	135 watts 1.25 amps
BTUS	460

ACCESSORIES

SOLD SEPARATELY

Add additional functionality and control with our selection of accessories and controls for the Jeeves Collection.



**DOUBLE GANG
PLATE**

SKUS	AJ-DGP-P
	AJ-DGP-B
	AJ-DGP-W
	AJ-DGP-O
	AJ-DGP-MB
LIST PRICE	US \$20



DOES NOT INCLUDE COVER PLATE

**PROGRAMMABLE
TIMER**

SCHEDULE ON/OFF TIMES

SKU	ATW-T24
LIST PRICE	US \$60

5 YEAR LIMITED WARRANTY

BLACK COLOR CHANGE KIT:
ATW-T24-BL - US \$10



DOES NOT INCLUDE COVER PLATE

**COUNTDOWN
TIMER**

DELAYED SHUT-OFF

SKU	ATW-CDT
LIST PRICE	US \$60

5 YEAR LIMITED WARRANTY

BLACK COLOR CHANGE KIT:
ATW-CDT-BL - US \$10



DOES NOT INCLUDE COVER PLATE

**PILOT LIGHT
SWITCH**

SWITCH W/ INDICATOR

SKU	ATW-S-A ATW-S-W
LIST PRICE	US \$30

5 YEAR LIMITED WARRANTY



BATHROBE HANGER

POLISHED & BRUSHED ONLY

SKUS	AJ-BHP
	AJ-BHB
LIST PRICE	US \$105



KSP
with Double Gang Plate
and Pilot Light Switch



CSP
MODEL C STRAIGHT
POLISHED



AJ-BHP
BATHROBE HANGER
POLISHED



DCB
MODEL D CURVED
BRUSHED



CCMB
MODEL C CURVED
MATTE BLACK

SPECIAL ORDERS

JEEVES COLLECTION

We are proud to offer a wide variety of additional sizes for our popular Jeeves Collection as special order items; these models have a lead time of approximately 12–14 weeks from date of payment recieved.

SHIPPING & HANDLING
NOT INCLUDED

LEAD TIMES
12–14 WEEKS

FROM RECEIPT OF PAYMENT
FOR SPECIAL ORDERS

WIDTH: 16 1/2"



MODEL N

HEIGHT: 68 1/2"
BARS: 28

240 Watts
2.18 Amps

NSP-16
NSB-16
NSO-16
NSW-16
NSMB-16

STRAIGHT:
US \$1880

WIDTH: 21 1/4"



NSP-20
NSB-20
NSO-20
NSW-20
NSMB-20

STRAIGHT:
US \$2040

WIDTH: 25 1/4"



NSP-24
NSB-24
NSO-24
NSW-24
NSMB-24

STRAIGHT:
US \$2240

WIDTH: 48"

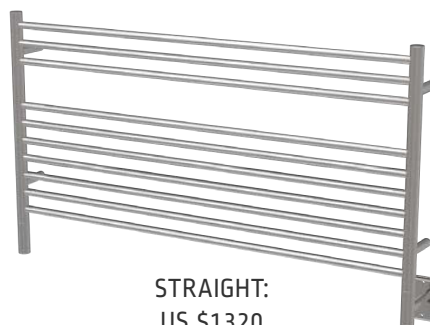

MODEL W

HEIGHT: 27"
BARS: 10

200–240 Watts
1.82–2.18 Amps

WSP-48
WSB-48
WSO-48
WSW-48
WSMB-48

STRAIGHT:
US \$1320

OPTIONS

RIGHT or LEFT
HARDWIRING

110 VOLT or 220 VOLT
ELECTRIC or HYDRONIC

Hydronic units carry additional cost
and require valves sold separately

FINISHES

SAME PRICE ANY FINISH



P

POLISHED

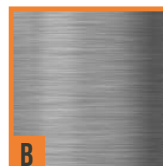

B

BRUSHED



O

OIL-RUBBED BRONZE



W

WHITE



MB

MATTE BLACK

MODEL H
HEIGHT: 18"
BARS: 7

WIDTH: 16 1/2"



STRAIGHT: US \$450
CURVED: US \$500

60 Watts
0.55 Amps

HSP-16
HSB-16
HSO-16
HSW-16
HSMB-16

HCP-16
HCB-16
HCO-16
HCW-16
HCMB-16

WIDTH: 25 1/2"



STRAIGHT: US \$540
CURVED: US \$600

80-100 Watts
0.73-0.91 Amps

HSP-24
HSB-24
HSO-24
HSW-24
HSMB-24

HCP-24
HCB-24
HCO-24
HCW-24
HCMB-24

MODEL E
HEIGHT: 31"
BARS: 12

WIDTH: 12 5/8"



STRAIGHT: US \$870

100 Watts
0.91 Amps

ESP-12
ESB-12
ESO-12
ESW-12
ESMB-12

WIDTH: 16 1/2"



STRAIGHT: US \$940
CURVED: US \$1040

135 Watts
0.23 Amps

ESP-16
ESB-16
ESO-16
ESW-16
ESMB-16

ECP-16
ECB-16
ECO-16
ECW-16
ECMB-16

WIDTH: 25 1/2"



STRAIGHT: US \$1130
CURVED: US \$1240

150-175 Watts
1.36-1.59 Amps

ESP-24
ESB-24
ESO-24
ESW-24
ESMB-24

ECP-24
ECB-24
ECO-24
ECW-24
ECMB-24

MODEL C
HEIGHT: 36"
BARS: 13

WIDTH: 12 5/8"



STRAIGHT: US \$1070

100-135 Watts
0.91-1.23 Amps

CSP-12
CSB-12
CSO-12
CSW-12
CSMB-12

WIDTH: 16 1/2"



STRAIGHT: US \$1160
CURVED: US \$1280

135-150 Watts
1.23-1.36 Amps

CSP-16
CSB-16
CSO-16
CSW-16
CSMB-16

CCP-16
CCB-16
CCO-16
CCW-16
CCMB-16

WIDTH: 26 1/2"



STRAIGHT: US \$1390
CURVED: US \$1530

150-200 Watts
1.36-1.82 Amps

CSP-24
CSB-24
CSO-24
CSW-24
CSMB-24

CCP-24
CCB-24
CCO-24
CCW-24
CCMB-24

MODEL D
HEIGHT: 53"
BARS: 20

WIDTH: 12 5/8"



STRAIGHT: US \$1380

175-200 Watts
1.59-1.82 Amps

DSP-12
DSB-12
DSO-12
DSW-12
DSMB-12

WIDTH: 16 1/2"



STRAIGHT: US \$1500
CURVED: US \$1660

200 Watts
1.82 Amps

DSP-16
DSB-16
DSO-16
DSW-16
DSMB-16

DCP-16
DCB-16
DCO-16
DCW-16
DCMB-16

WIDTH: 25 1/2"



STRAIGHT: US \$1790
CURVED: US \$1980

240 Watts
2.18 Amps

DSP-24
DSB-24
DSO-24
DSW-24
DSMB-24

DCP-24
DCB-24
DCO-24
DCW-24
DCMB-24



SIRIO COLLECTION



HARDWIRED



DRY ELEMENT
SYSTEM

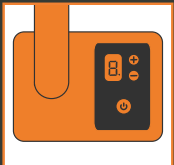

DIGITAL HEAT
CONTROLLER



3-YEAR LIMITED
WARRANTY



LEFT-ASSEMBLY
SPECIAL ORDER



S2942P
POLISHED

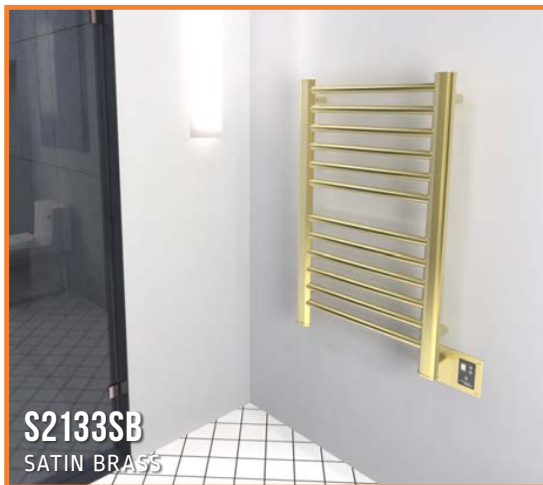

S2133SB
SATIN BRASS



S2142P
POLISHED

The stylish, Italian-made Sirio Collection features a contemporary design with round horizontal bars. This versatile Collection is perfect for drying and warming towels. Made of high quality stainless steel, the Sirio Collection is offered in brushed, polished, oil rubbed bronze and satin brass finishes. We offer additional sizes and colors as special order items. Each Sirio (excluding S2121) includes a digital heat controller, allowing the choice of 9 different heat levels.

115 VOLT

STANDARD VOLTAGE

131°F–167°F

AVERAGE TEMP RANGE

10–20M

WARM-UP TIME

304-GRADE
STAINLESS STEEL

ADDITIONAL SIZES

SEE SPECIAL ORDER SECTION

SIRIO COLLECTION



	RAIL WIDTH	RAIL HEIGHT	OVERALL WIDTH	OVERALL HEIGHT	DEPTH	WATTAGE	AMPS	BARS	BTUS	TOWELS
S2121	21"	21 1/2"	21 3/8"	23 3/8"	4-4 3/4"	115	1	8	392	1
S2133	21"	33 1/4"	24 5/8"	35 1/8"	4-4 3/4"	172	1.50	12	586	1-2
S2142	21"	42 5/8"	24 5/8"	44 5/8"	4-4 3/4"	232	2	16	791	1-3
S2921	21"	21 5/8"	32 1/2"	23 3/8"	4-4 3/4"	148	1.30	8	505	1
S2933	28 7/8"	33 1/4"	32 1/2"	35 1/8"	4-4 3/4"	232	2.00	12	791	1-3
S2942	28 7/8"	42 5/8"	32 1/2"	44 5/8"	4-4 3/4"	296	2.60	16	1009	1-4

FINISHES



POLISHED

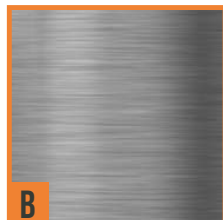

BRUSHED



OIL-RUBBED BRONZE



SATIN BRASS

MORE FINISHES AVAILABLE
SEE SPECIAL ORDERS PAGE

MODEL SKU

The SKU of each of our Italian-designed Heated Towel Racks identifies the Collection as well as the general dimensions of the rack itself, and finally the finish. All dimensions listed take into account the added width and height of the included digital heat controller/switch.

STOCKED ITEMS:

SAME PRICE ANY FINISH
SHIPS IN 1-2 DAYS (USA)

COLLECTION: SIRIO HEIGHT: ~21 INCHES

S 21 21 P

WIDTH: ~21 INCHES

FINISH: POLISHED

SIRIO COLLECTION

STOCKED ITEMS

S2121

SKU	Polished: S2121P	Brushed: S2121B	O.R Bronze: S2121O	Satin Brass: S2121SB
BARS	8			
WIDTH	21 3/8"			
HEIGHT	23 3/8"			
ELECTRICAL	115 watts 1.0 amps			
BTUS	392			



US \$780

DIGITAL HEAT CONTROLLER SOLD SEPARATELY AS AN OPTIONAL ADD-ON



US \$1,090

S2133

SKU	Polished: S2133P	Brushed: S2133B	O.R Bronze: S2133O	Satin Brass: S2133SB
BARS	12			
WIDTH	24 5/8"			
HEIGHT	35 1/8"			
ELECTRICAL	172 watts 1.5 amps			
BTUS	586			

S2142

SKU	Polished: S2142P	Brushed: S2142B	O.R Bronze: S2142O	Satin Brass: S2142SB
BARS	16			
WIDTH	24 5/8"			
HEIGHT	44 5/8"			
ELECTRICAL	232 watts 2.0 amps			
BTUS	791			



US \$1,290

STOCKED ITEMS

S2921

SKU	Polished: S2921P	Brushed: S2921B	O.R Bronze: S2921O	Satin Brass: S2921SB
BARS	8			
WIDTH	32 1/2"			
HEIGHT	23 3/8"			
ELECTRICAL	148 watts 1.3 amps			
BTUS	505			



US \$960



US \$1,210

S2933

SKU	Polished: S2933P	Brushed: S2933B	O.R Bronze: S2933O	Satin Brass: S2933SB
BARS	12			
WIDTH	32 1/2"			
HEIGHT	35 1/8"			
ELECTRICAL	232 watts 2.0 amps			
BTUS	791			



US \$1,430

S2942

SKU	Polished: S2942P	Brushed: S2942B	O.R Bronze: S2942O	Satin Brass: S2942SB
BARS	16			
WIDTH	32 1/2"			
HEIGHT	44 5/8"			
ELECTRICAL	296 watts 2.60 amps			
BTUS	1009			



DIGITAL HEAT CONTROLLER

Allows control of heat with 9 different settings. Operates as an on/off switch and comes standard with each Sirio model excluding the S2121.



ON/OFF SWITCH

Illuminated on/off switch — comes standard with the S2121 & can be purchased separately for any other Sirio models.



ACCESSORIES

SOLD SEPARATELY

Add additional functionality and control with our selection of accessories and controls for the Sirio Collection.



BATHROBE HANGER

POLISHED & BRUSHED ONLY

SKUS	AS-BHP AS-BHB
LIST PRICE	US \$105



DOES NOT INCLUDE COVER PLATE

PROGRAMMABLE TIMER

SCHEDULE ON/OFF TIMES

SKU	ATW-T24
LIST PRICE	US \$60

5 YEAR LIMITED WARRANTY
BLACK COLOR CHANGE KIT:
ATW-T24-BL - US \$10



DOES NOT INCLUDE COVER PLATE

COUNTDOWN TIMER

DELAYED SHUT-OFF

SKU	ATW-CDT
LIST PRICE	US \$60

5 YEAR LIMITED WARRANTY
BLACK COLOR CHANGE KIT:
ATW-CDT-BL - US \$10



S2942P
POLISHED

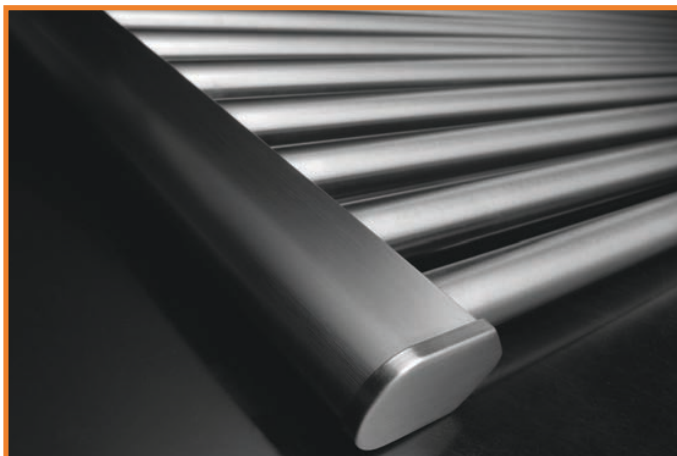

AS-BHP
BATHROBE HANGER
POLISHED

SPECIAL ORDERS

SIRIO COLLECTION

We are proud to offer a wide variety of additional sizes for our popular Sirio Collection as special order items; these models have a lead time of approximately 12–14 weeks from date of payment received.

SHIPPING & HANDLING
NOT INCLUDED

LEAD TIMES
12–14 WEEKS

FROM RECEIPT OF PAYMENT
FOR SPECIAL ORDERS

		HEIGHT					
		18 5/8"	23 3/8"	35 1/8"	44 5/8"	56 3/8"	61 1/8"
WIDTH	20 5/8"	S1716 US\$1,017	S1721 US\$1,118	S1733 US\$1,574	S1742 US\$1,707	S1754 US\$1,827	S1759 US\$1,941
	24 5/8"	S2116 US\$1,050	S2121* STOCKED ITEM [Ships in 1–2 Days]	S2133 STOCKED ITEM [Ships in 1–2 Days]	S2142 STOCKED ITEM [Ships in 1–2 Days]	S2154 US\$1,930	S2159 US\$2,065
	28 1/2"	S2516 US\$1,083	S2521 US\$1,201	S2533 US\$1,745	S2542 US\$1,903	S2554 US\$2,033	S2559 US\$2,177
	32 1/2"	S2916 US\$1,116	S2921 STOCKED ITEM [Ships in 1–2 Days]	S2933 STOCKED ITEM [Ships in 1–2 Days]	S2942 STOCKED ITEM [Ships in 1–2 Days]	S2954 US\$2,139	S2959 US\$2,294

* Dimensions: 21 3/4" x 23 1/3"— does not include Digital Heat Controller

6 BARS

8 BARS

12 BARS

16 BARS

20 BARS

22 BARS

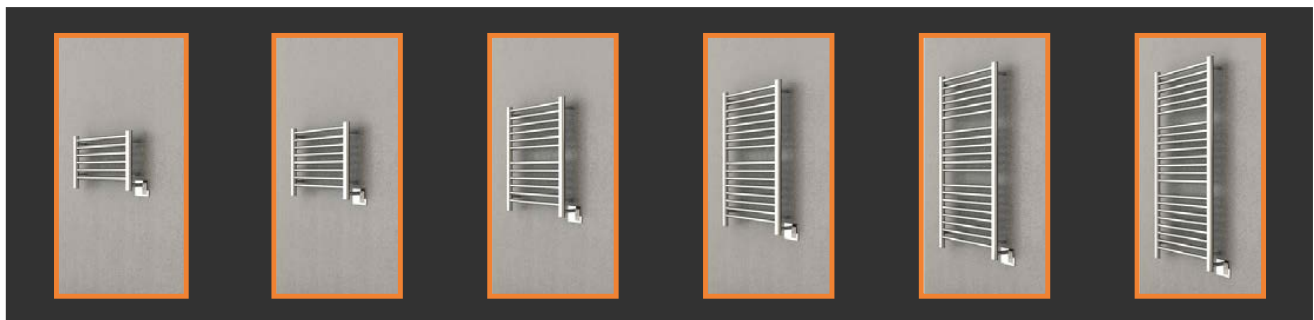

OPTIONS

SIRIO

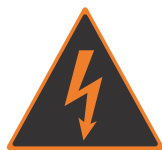

115 VOLT
or
220 VOLT

220V MODELS CARRY ADDITIONAL COST

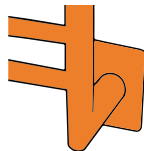

RIGHT
or
LEFT
HARDWIRING



ELECTRIC
or
HYDRONIC

HYDRONIC UNITS CARRY ADDITIONAL COST
AND REQUIRE VALVES SOLD SEPARATELY

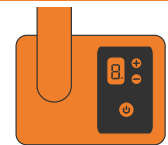

STANDARD
or
REMOTELY-WIRED

DIGITAL HEAT CONTROLLER

FINISHES



P

POLISHED

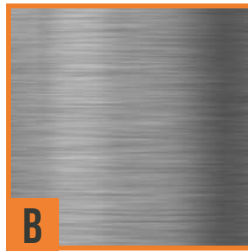

B

BRUSHED



O

OIL-RUBBED BRONZE

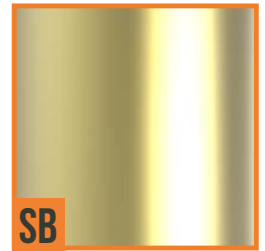

SB

SATIN BRASS



RAL CUSTOM COLORS

RAL refers to the RAL Classic system, mainly used for varnish and powder coating – each color is represented by a four digit code which can be used to order a unique color for our Sirio Special Order Heated Towel Racks.

CUSTOM COLOR PRICES ON REQUEST

ULTRA-WIDE

59 7/8" x 22"

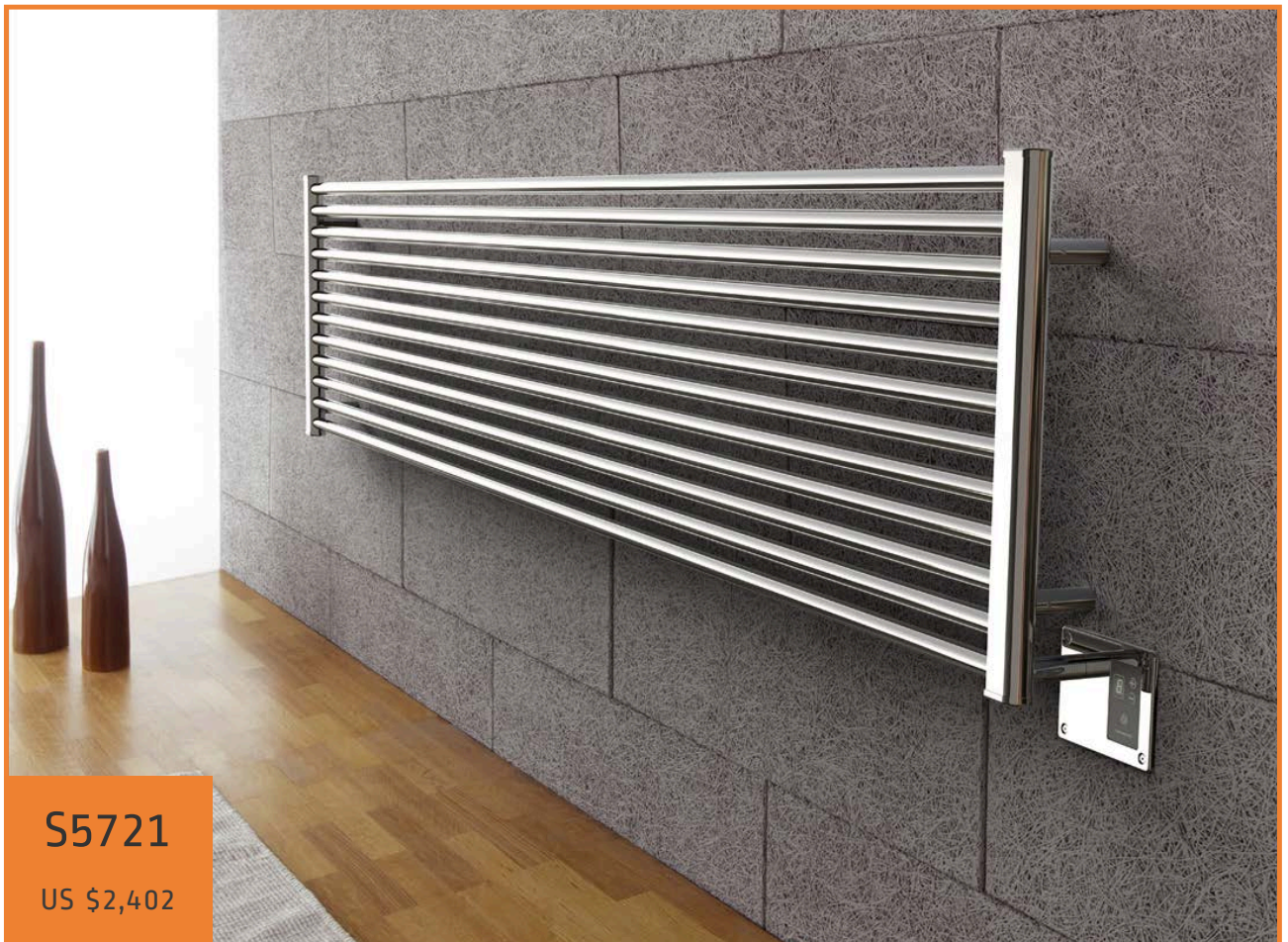

S5721

US \$2,402



QUADRO COLLECTION



HARDWIRED

DE

DRY ELEMENT
SYSTEM



DIGITAL HEAT
CONTROLLER

3

3-YEAR LIMITED
WARRANTY



LEFT-ASSEMBLY
SPECIAL ORDER



Q2833B
BRUSHED



Q2042P
POLISHED

The stylish, Italian-made Quadro Collection features a modern design with square bars. This versatile Collection is perfect for drying and warming towels. Made of high quality stainless steel, the Quadro Collection is offered in polished, brushed, and matte black finishes. We offer additional sizes and colors as special order items. Each Quadro [excluding Q2016] includes a digital heat controller, allowing the choice of 9 different heat levels.

115 VOLT
STANDARD VOLTAGE

131°F–167°F
AVERAGE TEMP RANGE

10–20M
WARM-UP TIME

**304-GRADE
STAINLESS STEEL**

ADDITIONAL SIZES
SEE SPECIAL ORDER SECTION

QUADRO COLLECTION



	RAIL WIDTH	RAIL HEIGHT	OVERALL WIDTH	OVERALL HEIGHT	DEPTH	WATTAGE	AMPS	BTUS	BARS	TOWELS
Q2016	20 1/2"	16 3/4"	21 1/8"	18 7/8"	4-4 3/4"	92	0.8	314	6	1
Q2033	20 1/2"	33 1/4"	24 3/8"	35 3/8"	4-4 3/4"	172	1.5	586	12	1-2
Q2042	20 1/2"	42 5/8"	24 3/8"	44 3/4"	4-4 3/4"	232	2.0	791	16	1-3
Q2054	20 1/2"	54 1/2"	24 3/8"	56 5/8"	4-4 3/4"	296	2.6	1009	20	1-4
Q2833	28 1/2"	33 1/4"	32 1/4"	35 3/8"	4-4 3/4"	232	2.00	791	12	1-3
Q2842	28 1/2"	42 5/8"	32 1/4"	44 3/4"	4-4 3/4"	296	2.6	1009	16	1-4

FINISHES



POLISHED

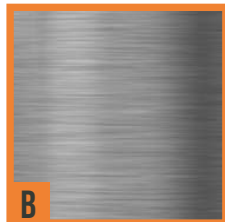

BRUSHED



MATTE BLACK

MORE FINISHES AVAILABLE
SEE SPECIAL ORDERS PAGE

MODEL SKU

The SKU of each of our Italian-designed Heated Towel Racks identifies the Collection as well as the general dimensions of the rack itself, and finally the finish. All dimensions listed take into account the added width and height of the included digital heat controller/switch.

STOCKED ITEMS:

SAME PRICE ANY FINISH
SHIPS IN 1-2 DAYS [USA]

MODEL: QUADRO HEIGHT: ~33 INCHES

Q 20 33 P

WIDTH: ~20 INCHES

FINISH: POLISHED

QUADRO COLLECTION

STOCKED ITEMS



US \$680

Q2016

SKU	Polished: Q2016P	Brushed: Q2016B	Matte Black: Q2016MB
BARS	6		
WIDTH	21 1/8"		
HEIGHT	18 7/8"		
ELECTRICAL	92 watts 1.0 amps		
BTUS	314		



US \$1,210

Q2033

SKU	Polished: Q2033P	Brushed: Q2033B	Matte Black: Q2033MB
BARS	12		
WIDTH	24 3/8"		
HEIGHT	35 3/8"		
ELECTRICAL	172 watts 1.5 amps		
BTUS	586		



US \$1,430

Q2042

SKU	Polished: Q2042P	Brushed: Q2042B	Matte Black: Q2042MB
BARS	16		
WIDTH	24 3/8"		
HEIGHT	44 3/4"		
ELECTRICAL	232 watts 2.0 amps		
BTUS	791		



US \$1,780

Q2054

SKU	Polished: Q2054P	Brushed: Q2054B	Matte Black: Q2054MB
BARS	20		
WIDTH	24 3/8"		
HEIGHT	56 5/8"		
ELECTRICAL	296 watts 2.6 amps		
BTUS	1009		

QUADRO COLLECTION

STOCKED ITEMS



US \$1,400

Q2833

SKU	Polished: Q2833P Brushed: Q2833B Matte Black: Q2833MB
BARS	12
WIDTH	32 1/4"
HEIGHT	35 3/8"
ELECTRICAL	232 watts 2.00 amps
BTUS	791



US \$1,670

Q2842

SKU	Polished: Q2842P Brushed: Q2842B Matte Black: Q2842MB
BARS	16
WIDTH	32 1/4"
HEIGHT	44 3/4"
ELECTRICAL	296 watts 2.6 amps
BTUS	1009



Q2833P
POLISHED



DIGITAL HEAT CONTROLLER

Allows control of heat with 9 different settings. Operates as an on/off switch and comes standard with each Quadro model excluding the Q2016.



ON/OFF SWITCH

Illuminated on/off switch — comes standard with the Q2016 & can be purchased separately for any other Quadro models.

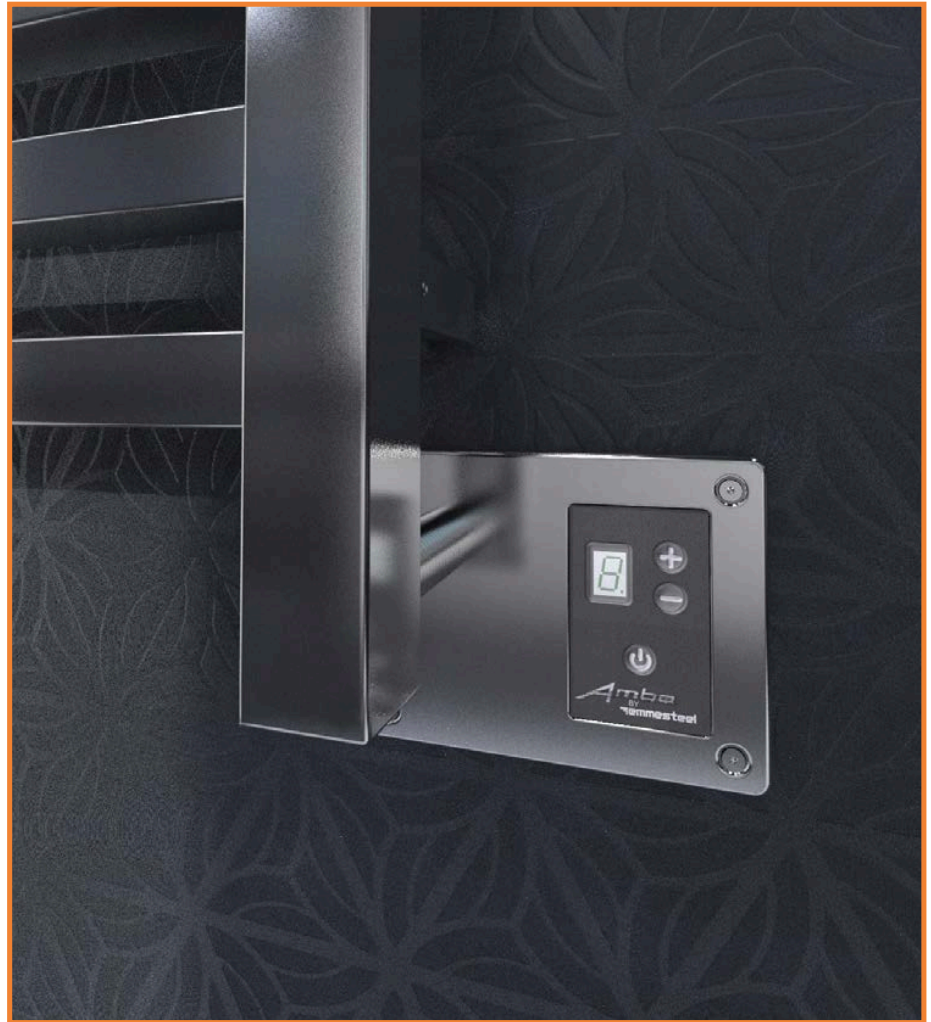

ACCESSORIES

SOLD SEPARATELY

Add additional functionality and control with our selection of accessories and controls for the Quadro Collection.

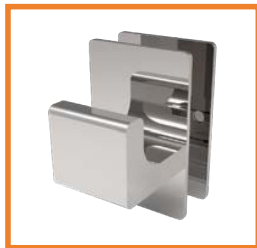

BATHROBE HANGER

POLISHED & BRUSHED ONLY

SKU	AQ-BHP AQ-BHB
LIST PRICE	US \$120



DOES NOT INCLUDE COVER PLATE

PROGRAMMABLE TIMER

SCHEDULE ON/OFF TIMES

SKU	ATW-T24
LIST PRICE	US \$60

5 YEAR LIMITED WARRANTY
BLACK COLOR CHANGE KIT:
ATW-T24-BL - US \$10



DOES NOT INCLUDE COVER PLATE

COUNTDOWN TIMER

DELAYED SHUT-OFF

SKU	ATW-CDT
LIST PRICE	US \$60

5 YEAR LIMITED WARRANTY
BLACK COLOR CHANGE KIT:
ATW-CDT-BL - US \$10



Q2054P
POLISHED



Q2016P
POLISHED



BATHROBE HANGER
AQ-BHP
POLISHED

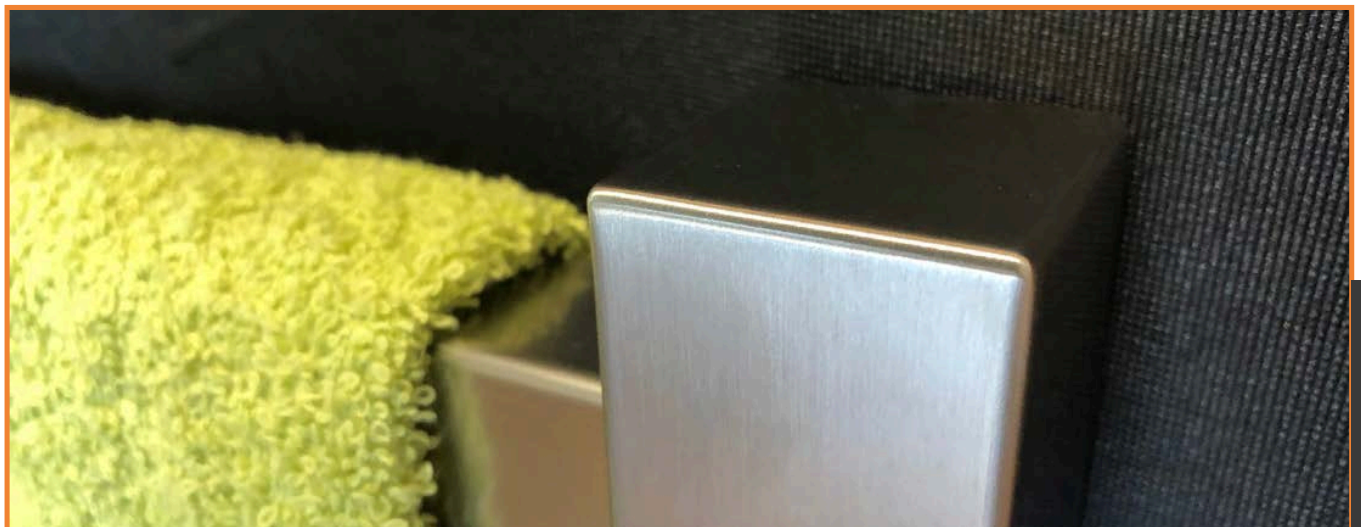

SPECIAL ORDERS

QUADRO COLLECTION

We are proud to offer a wide variety of additional sizes for our popular Quadro Collection as special order items; these models have a lead time of approximately 12–14 weeks from date of payment received.

SHIPPING & HANDLING
NOT INCLUDED

LEAD TIMES
12–14 WEEKS

FROM RECEIPT OF PAYMENT
FOR SPECIAL ORDERS

		HEIGHT					
		18 3/4"	23 1/2"	35 3/8"	44 3/4"	56 5/8"	61 3/8"
WIDTH	20 3/8"	Q1816 US\$1,168	Q1821 US\$1,304	Q1833 US\$1,600	Q1842 US\$1,895	Q1854 US\$2,198	Q1859 US\$2,360
	24 3/8"	Q2016* STOCKED ITEM [Ships in 1–2 Days]	Q2021 US\$1,356	Q2033 STOCKED ITEM [Ships in 1–2 Days]	Q2042 STOCKED ITEM [Ships in 1–2 Days]	Q2054 STOCKED ITEM [Ships in 1–2 Days]	Q2059 US\$2,456
	28 1/4"	Q2416 US\$1,249	Q2421 US\$1,408	Q2433 US\$1,709	Q2442 US\$2,038	Q2454 US\$2,375	Q2459 US\$2,568
	32 1/4"	Q2816 US\$1,290	Q2821 US\$1,433	Q2833 STOCKED ITEM [Ships in 1–2 Days]	Q2842 STOCKED ITEM [Ships in 1–2 Days]	Q2854 STOCKED ITEM [Ships in 1–2 Days]	Q2859 US\$2,660

*Dimensions: 21 1/8" x 18 3/4" – does not include Digital Heat Controller

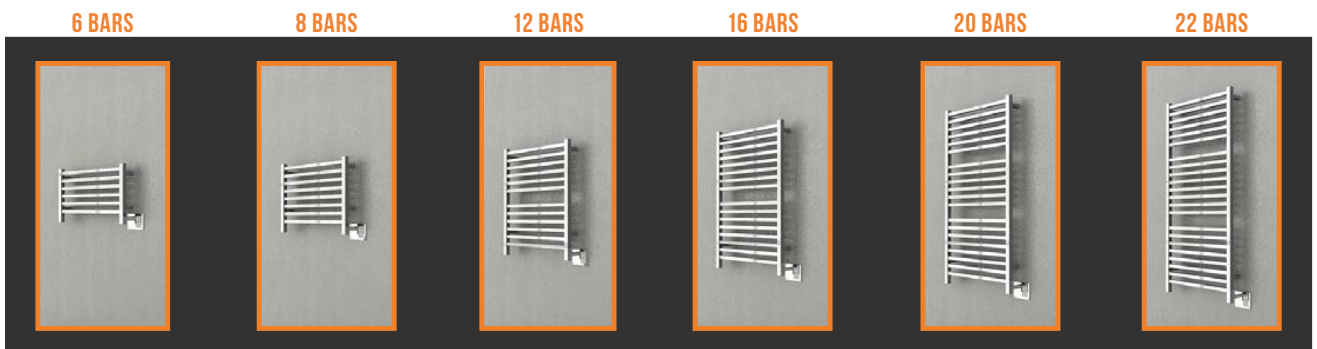

OPTIONS

QUADRO



115 VOLT
or
220 VOLT

220V MODELS CARRY ADDITIONAL COST

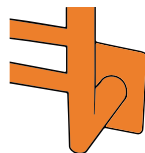

RIGHT
or
LEFT

HARDWIRING



ELECTRIC
or
HYDRONIC

HYDRONIC UNITS CARRY ADDITIONAL COST
AND REQUIRE VALVES SOLD SEPARATELY



STANDARD
or
REMOTELY-WIRED

DIGITAL HEAT CONTROLLER

FINISHES



POLISHED

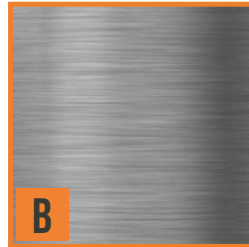

BRUSHED



MATTE BLACK



RAL CUSTOM COLORS

RAL refers to the RAL Classic system, mainly used for varnish and powder coating – each color is represented by a four digit code which can be used to order a unique color for our Quadro Special Order Heated Towel Racks.

CUSTOM COLORS AND PVD FINISH – PRICES AND AVAILABILITY ON REQUEST



Q2459P
POLISHED
PUSH BUTTON SWITCH
& BATHROBE HANGER



VEGA COLLECTION



HARDWIRED



DRY ELEMENT SYSTEM



DIGITAL HEAT CONTROLLER



3-YEAR LIMITED WARRANTY



LEFT-ASSEMBLY SPECIAL ORDER



The stylish, Italian-made Vega Collection features a modern design with large horizontal panels rather than bars that are perfect for drying and warming towels thanks to their added surface area. Made of high quality stainless steel, the Vega Collection is offered in polished, brushed, white, and matte black. We offer additional sizes and colors as special order items. Each Vega includes a digital heat controller, allowing the choice of 9 different heat levels.

115 VOLT
STANDARD VOLTAGE

131°F–167°F
AVERAGE TEMP RANGE

10–20M
WARM-UP TIME

304-GRADE
STAINLESS STEEL

ADDITIONAL SIZES
SEE SPECIAL ORDER SECTION

VEGA COLLECTION

FINISHES



P

POLISHED

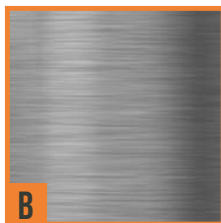

B

BRUSHED



W

WHITE



MB

MATTE BLACK

MORE FINISHES AVAILABLE
SEE SPECIAL ORDERS PAGE



V2338

V2356

	RAIL WIDTH	RAIL HEIGHT	OVERALL WIDTH	OVERALL HEIGHT	DEPTH	WATTAGE	AMPS	BTUS	BARS	TOWELS
V2338	22 7/8"	37 1/4"	26 1/4"	39"	3 5/8"	250	2.17	853	8	1-2
V2356	22 7/8"	55 7/8"	26 1/4"	57 3/4"	3 5/8"	370	3.21	1262	12	1-4



MODEL SKU

The SKU of each of our Italian-designed Heated Towel Racks identifies the Collection as well as the general dimensions of the rack itself, and finally the finish. All dimensions listed take into account the added width and height of the included digital heat controller/switch.

STOCKED ITEMS:
SAME PRICE ANY FINISH
SHIPS IN 1-2 DAYS (USA)

MODEL: VEGA HEIGHT: ~37 INCHES

V 23 38 P

WIDTH: ~23 INCHES

FINISH: POLISHED

VEGA COLLECTION

STOCKED ITEMS

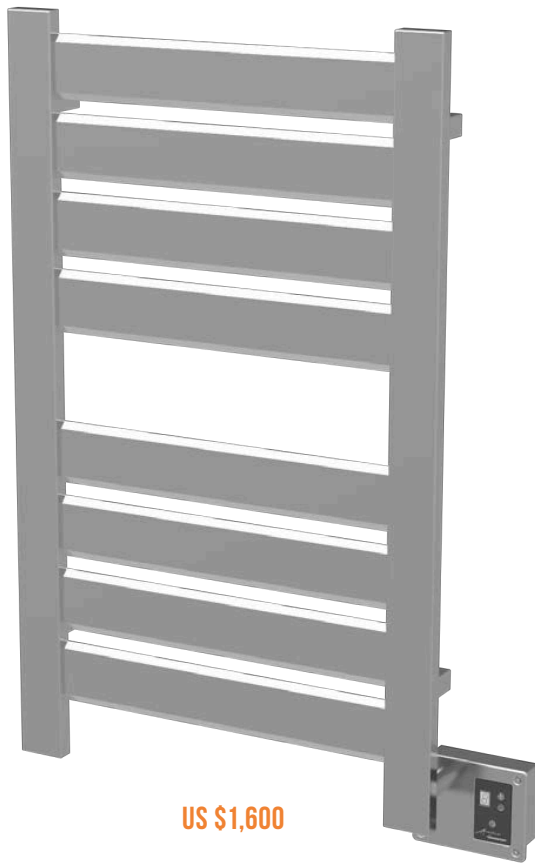

US \$1,600

V2338

SKU	Polished: V2338P	Brushed: V2338B	White: V2338W	Matte Black: V2338MB
BARS	8			
WIDTH	26 1/4"			
HEIGHT	39"			
ELECTRICAL	250 watts 2.17 amps			
BTUS	853			

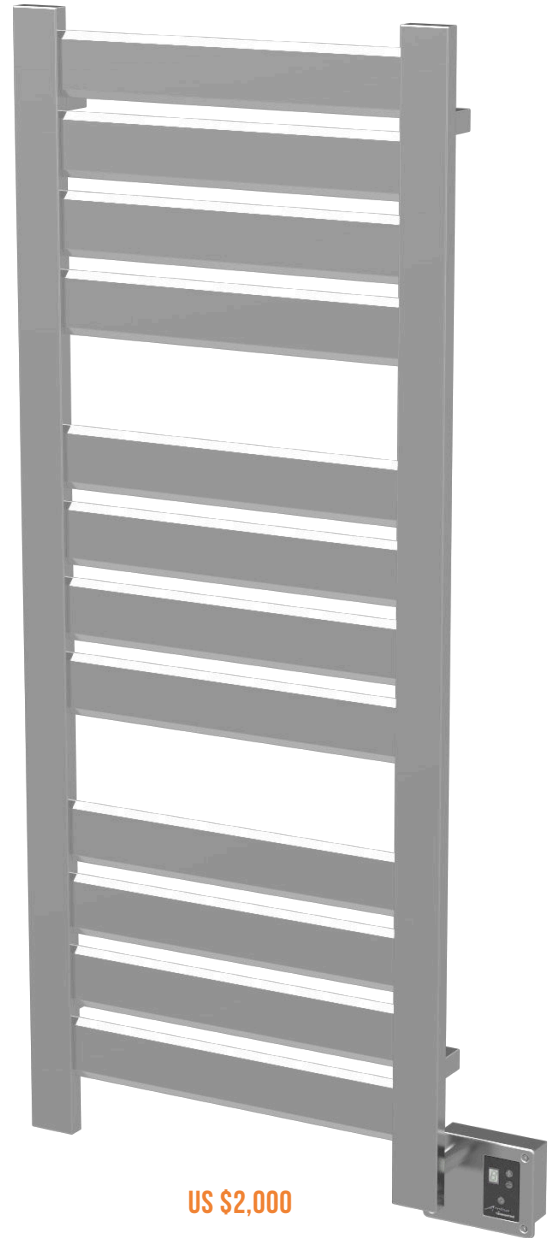

US \$2,000

V2356

SKU	Polished: V2356P	Brushed: V2356B	White: V2356W	Matte Black: V2356MB
BARS	12			
WIDTH	26 1/4"			
HEIGHT	59 3/4"			
ELECTRICAL	370 watts 3.21 amps			
BTUS	1262			



DIGITAL HEAT CONTROLLER

Allows control of heat with 9 different settings. Operates as an on/off switch and comes standard with each Vega model.



ON/OFF SWITCH

Illuminated on/off switch – can be purchased separately as a replacement for the Digital Heat Controller.



ACCESSORIES
SOLD SEPARATELY

Add additional functionality and control with our selection of accessories and controls for the Vega Collection.



BATHROBE HANGER

POLISHED & BRUSHED ONLY

SKUS	AV-BHP AV-BHB
LIST PRICE	US \$120



DOES NOT INCLUDE COVER PLATE

PROGRAMMABLE TIMER

SCHEDULE ON/OFF TIMES

SKU	ATW-T24
LIST PRICE	US \$60

5 YEAR LIMITED WARRANTY
BLACK COLOR CHANGE KIT:
ATW-T24-BL - US \$10



DOES NOT INCLUDE COVER PLATE

COUNTDOWN TIMER

DELAYED SHUT-OFF

SKU	ATW-CDT
LIST PRICE	US \$60

5 YEAR LIMITED WARRANTY
BLACK COLOR CHANGE KIT:
ATW-CDT-BL - US \$10

SPECIAL ORDERS

Vega COLLECTION

We are proud to offer a wide variety of additional sizes for our popular Vega Collection as special order items; these models have a lead time of approximately 12–14 weeks from date of payment received.

SHIPPING & HANDLING
NOT INCLUDED

LEAD TIMES
12–14 WEEKS

FROM RECEIPT OF PAYMENT
FOR SPECIAL ORDERS

		HEIGHT			
		20 1/2"	39 1/8"	59 7/8"	76 5/8"
WIDTH	20 3/4"	V1819 US\$1,227	V1838 US\$1,727	V1856 US\$2,265	V1875 US\$2,875
	26 1/4"	V2319 US\$1,270	V2338 STOCKED ITEM [Ships in 1–2 Days]	V2356 STOCKED ITEM [Ships in 1–2 Days]	V2375 US\$3,106
	31 3/4"	V2819 US\$1,374	V2838 US\$2,044	V2856 US\$2,718	V2875 US\$3,486
		4 BARS	8 BARS	12 BARS	16 BARS

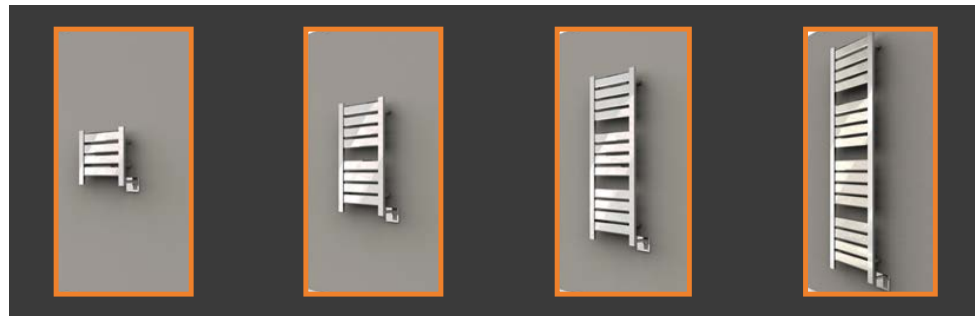

OPTIONS

VEGA

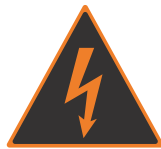

115 VOLT
or
220 VOLT

220V MODELS CARRY ADDITIONAL COST

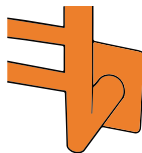

RIGHT
or
LEFT

HARDWIRING



ELECTRIC
or
HYDRONIC

HYDRONIC UNITS CARRY ADDITIONAL COST
AND REQUIRE VALVES SOLD SEPARATELY

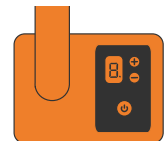

STANDARD
or
REMOTELY-WIRED

DIGITAL HEAT CONTROLLER

FINISHES



P

POLISHED

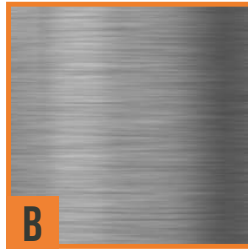

B

BRUSHED



W

WHITE



MB

MATTE BLACK



RAL CUSTOM COLORS

RAL refers to the RAL Classic system, mainly used for varnish and powder coating – each color is represented by a four digit code which can be used to order a unique color for our Vega Special Order Heated Towel Racks.

CUSTOM COLORS AND PVD FINISH – PRICES AND AVAILABILITY ON REQUEST





ELORY COLLECTION



HARDWIRED



DRY ELEMENT
SYSTEM

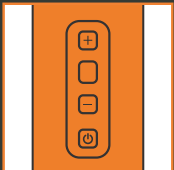

INTEGRATED
DIGITAL HEAT
CONTROLLER



3-YEAR LIMITED
WARRANTY



LEFT-ASSEMBLY
SPECIAL ORDER



E2130P
POLISHED

The stylish, Italian-made Elory Collection features a single-panel design with an integrated Digital Heat Controller. Perfect drying and warming towels with a large surface area, each model is made of high quality stainless steel offered in polished and brushed stainless steel. We offer additional sizes and colors as special order items. The integrated Digital Heat Controller allows the heat output to be controlled with a choice of 9 different heat levels.

115 VOLT
STANDARD VOLTAGE

131°F–167°F
AVERAGE TEMP RANGE

10–20M
WARM-UP TIME

**304-GRADE
STAINLESS STEEL**

ADDITIONAL SIZES
SEE SPECIAL ORDER SECTION

FINISHES



P

POLISHED

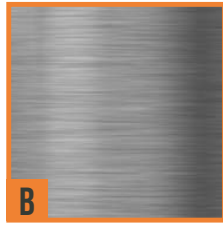

B

BRUSHED

MORE FINISHES AVAILABLE

SEE SPECIAL ORDERS PAGE

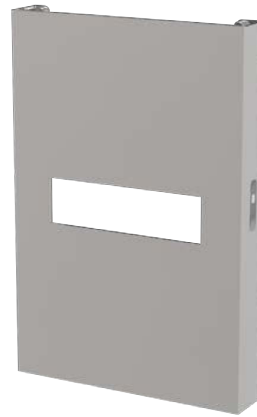

E2130



E2830

	WIDTH	HEIGHT	DEPTH	WATTAGE	AMPS	BTUS	PANELS	TOWELS
E2130	20 1/2"	30 3/8"	3 1/2"	180	1.6	614	1	1-2
E2830	28 3/8"	30 3/8"	3 1/2"	270	2.3	921	1	1-2



E2830B
BRUSHED

MODEL SKU

The SKU of each of our Italian-designed Heated Towel Racks identifies the Collection as well as the general dimensions of the rack itself, and finally the finish.

STOCKED ITEMS:

SAME PRICE ANY FINISH
SHIPS IN 1-2 DAYS (USA)

COLLECTION: ELORY **HEIGHT:** ~30 INCHES

E 28 30 P

WIDTH: ~28 INCHES

FINISH: POLISHED

ELORY COLLECTION

STOCKED ITEMS



US \$1,690

E2130

SKU	Polished: E2130P	Brushed: E2130B
WIDTH	20 1/2"	
HEIGHT	30 3/8"	
ELECTRICAL	180 watts 1.6 amps	
BTUS	614	



US \$1,800

E2830

SKU	Polished: E2830P	Brushed: E2830B
WIDTH	28 3/8"	
HEIGHT	30 3/8"	
ELECTRICAL	270 watts 2.3 amps	
BTUS	921	

INTEGRATED DIGITAL HEAT CONTROLLER

Allows control of heat with 9 different settings. Operates as an on/off switch and is built right into the side of each Elory Collection model.



ACCESSORIES

SOLD SEPARATELY

Add additional functionality and control with our selection of accessories and controls for the Elory Collection.



DOES NOT INCLUDE COVER PLATE

PROGRAMMABLE TIMER

SCHEDULE ON/OFF TIMES

SKU	ATW-T24
LIST PRICE	US \$60

5 YEAR LIMITED WARRANTY
BLACK COLOR CHANGE KIT:
ATW-T24-BL - US \$10



DOES NOT INCLUDE COVER PLATE

COUNTDOWN TIMER

DELAYED SHUT-OFF

SKU	ATW-CDT
LIST PRICE	US \$60

5 YEAR LIMITED WARRANTY
BLACK COLOR CHANGE KIT:
ATW-CDT-BL - US \$10

SPECIAL ORDERS

ELORY COLLECTION

We are proud to offer a wide variety of additional sizes for our popular Elory Collection as special order items; these models have a lead time of approximately 12–14 weeks from date of payment received.

SHIPPING & HANDLING
NOT INCLUDED

LEAD TIMES

12–14 WEEKS

FROM RECEIPT OF PAYMENT
FOR SPECIAL ORDERS

		HEIGHT				
		12 5/8"	30 3/8"	41 3/4"	53 1/8"	64 1/2"
WIDTH	20 1/2"	E2113 US\$1,321	E2130 STOCKED ITEM [Ships in 1–2 Days]	E2142 US\$2,203	E2153 US\$2,599	E2164 US\$3,057
	28 3/8"	E2813 US\$1,433	E2830 STOCKED ITEM [Ships in 1–2 Days]	E2842 US\$2,466	E2853 US\$2,864	E2864 US\$3,324



OPTIONS

ELORY



115 VOLT or 220 VOLT
 220V models carry additional cost

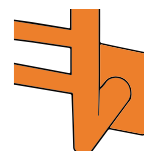

RIGHT or LEFT
 HARDWIRING

FINISHES



P

POLISHED

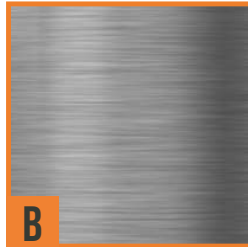

B

BRUSHED



RAL CUSTOM COLORS

RAL refers to the RAL Classic system, mainly used for varnish and powder coating – each color is represented by a four digit code which can be used to order a unique color for our Elory Special Order Heated Towel Racks.

CUSTOM COLOR AND PVD – PRICES AND AVAILABILITY ON REQUEST



E2064B
BRUSHED
SPECIAL ORDER MODEL



ANTUS COLLECTION



HARDWIRED

DE

DRY ELEMENT
SYSTEM



DIGITAL HEAT
CONTROLLER

3

3-YEAR LIMITED
WARRANTY



LEFT-ASSEMBLY
SPECIAL ORDER



A2856P
POLISHED



A2856P
POLISHED



The stylish, Italian-made Antus Collection features a contemporary design with round horizontal bars. This versatile Collection is perfect for drying and warming towels. Made of high quality stainless steel, the Antus Collection is offered in brushed and polished stainless steel. We offer additional sizes as special order items. Each Antus includes a digital heat controller, allowing the choice of 9 different heat levels.

115 VOLT

STANDARD VOLTAGE

131°F–167°F

AVERAGE TEMP RANGE

10–20M

WARM-UP TIME

304-GRADE
STAINLESS STEEL

ADDITIONAL SIZES

SEE SPECIAL ORDER SECTION

ANTUS COLLECTION

FINISHES



P

POLISHED

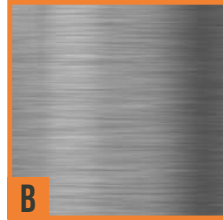

B

BRUSHED



A2056



A2856

	RAIL WIDTH	RAIL HEIGHT	OVERALL WIDTH	OVERALL HEIGHT	DEPTH	WATTAGE	AMPS	BTUS	BARS	TOWELS
A2056	19 5/8"	56 1/4"	23 5/8"	58 3/8"	4 5/16"	400	3.5	1364	32	2-4
A2856	27 1/2"	56 1/4"	31 1/2"	58 3/8"	4 5/16"	530	4.6	1807	32	2-4

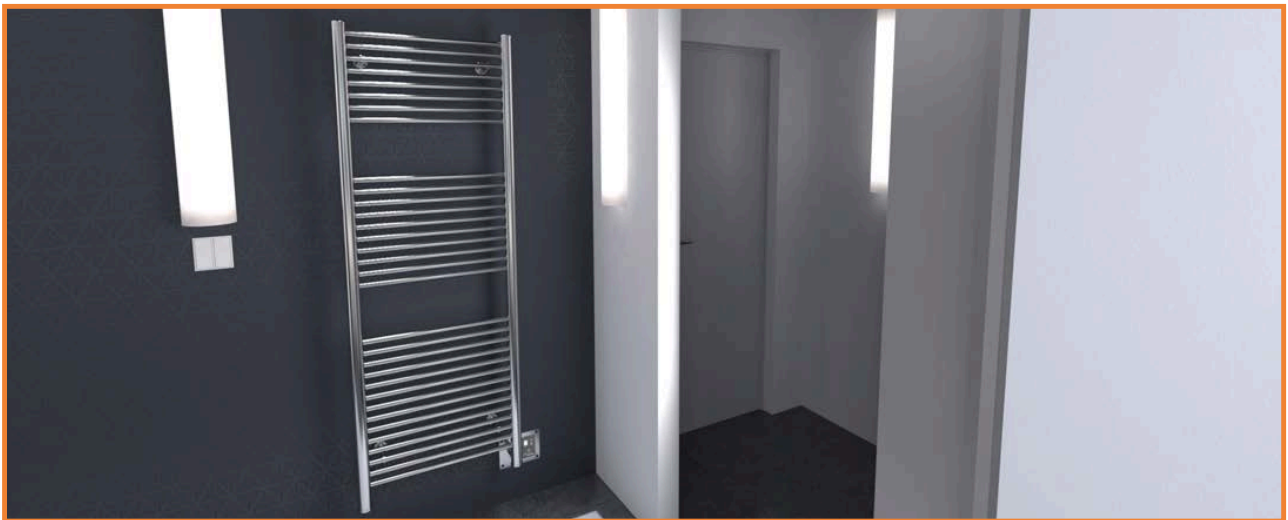

MODEL SKU

The SKU of each of our Italian-designed Heated Towel Racks identifies the Collection as well as the general dimensions of the rack itself, and finally the finish. All dimensions listed take into account the added width and height of the included digital heat controller/switch.

STOCKED ITEMS:

SAME PRICE ANY FINISH
SHIPS IN 1-2 DAYS (US)

MODEL: **ANTUS** HEIGHT: **~56 INCHES**

A 20 56 P

WIDTH: **~20 INCHES**

FINISH: **POLISHED**

ANTUS COLLECTION

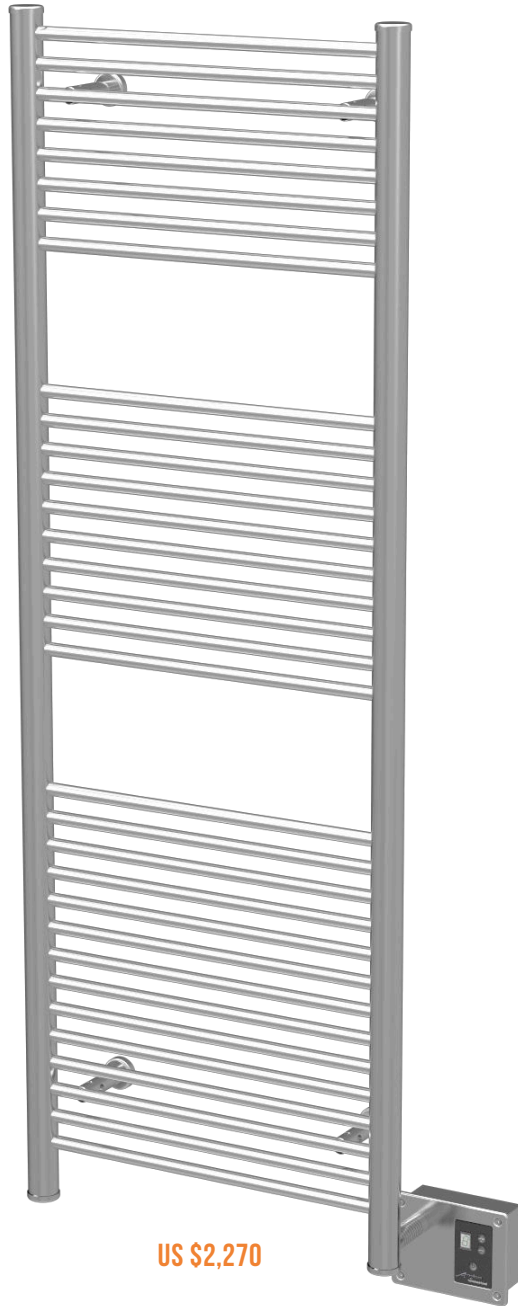

US \$2,270

A2056

SKU	Polished: A2056P	Brushed: A2056B
BARS	32	
WIDTH	23 5/8"	
HEIGHT	58 3/8"	
ELECTRICAL	400 watts 3.5 amps	
BTUS	1364	

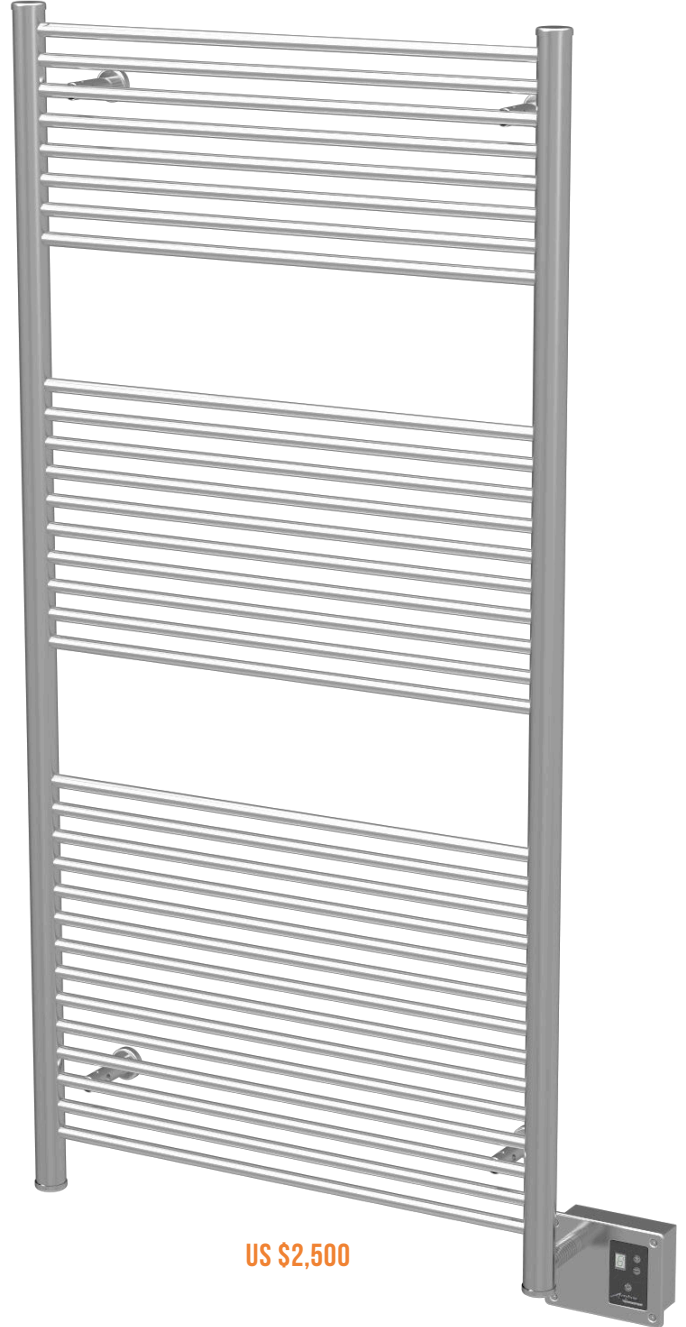

US \$2,500

A2856

SKU	Polished: A2856P	Brushed: A2856B
BARS	32	
WIDTH	31 1/2"	
HEIGHT	58 3/8"	
ELECTRICAL	530 watts 4.6 amps	
BTUS	1807	



DIGITAL HEAT CONTROLLER

Allows control of heat with 9 different settings. Operates as an on/off switch and comes standard with each Antus model.



ON/OFF SWITCH

Illuminated on/off switch – can be purchased separately as a replacement for the Digital Heat Controller.



ACCESSORIES

SOLD SEPARATELY

Add additional functionality and control with our selection of accessories and controls for the Antus Collection.



BATHROBE HANGER

POLISHED & BRUSHED ONLY

SKU	AS-BHP AS-BHB
LIST PRICE	US \$105



DOES NOT INCLUDE COVER PLATE

PROGRAMMABLE TIMER

SCHEDULE ON/OFF TIMES

SKU	ATW-T24
LIST PRICE	US \$60

5 YEAR LIMITED WARRANTY
BLACK COLOR CHANGE KIT:
ATW-T24-BL - US \$10



DOES NOT INCLUDE COVER PLATE

COUNTDOWN TIMER

DELAYED SHUT-OFF

SKU	ATW-CDT
LIST PRICE	US \$60

5 YEAR LIMITED WARRANTY
BLACK COLOR CHANGE KIT:
ATW-CDT-BL - US \$10

SPECIAL ORDERS

ANTUS COLLECTION

We are proud to offer a wide variety of additional sizes for our popular Antus Collection as special order items; these models have a lead time of approximately 12–14 weeks from date of payment received.

SHIPPING & HANDLING
NOT INCLUDED

LEAD TIMES
12–14 WEEKS

FROM RECEIPT OF PAYMENT
FOR SPECIAL ORDERS

		HEIGHT					
		42 3/8"	50 3/8"	58 3/8"	66 1/2"	74 1/2"	82 1/2"
WIDTH	19 5/8"	A1640 US\$1,786	A1648 US\$2,038	A1656 US\$2,315	A1664 US\$2,589	A1672 US\$2,848	A1680 US\$3,126
	23 5/8"	A2040 US\$1,864	A2048 US\$2,137	A2056 STOCKED ITEM [Ships in 1–2 Days]	A2064 US\$2,725	A2072 US\$3,015	A2080 US\$3,317
	27 1/2"	A2440 US\$1,955	A2448 US\$2,250	A2456 US\$2,565	A2464 US\$2,887	A2472 US\$3,203	A2480 US\$3,508
	31 1/2"	A2840 US\$2,034	A2848 US\$2,340	A2856 STOCKED ITEM [Ships in 1–2 Days]	A2864 US\$3,301	A2872 US\$3,372	A2880 US\$3,723
	35 3/8"	A3240 US\$2,096	A3248 US\$2,446	A3256 US\$2,816	A3264 US\$3,185	A3272 US\$3,550	A3280 US\$3,902
	39 3/8"	A3540 US\$2,182	A3548 US\$2,553	A3556 US\$2,948	A3564 US\$3,342	A3572 US\$3,715	A3580 US\$4,115
		20 BARS	26 BARS	32 BARS	38 BARS	44 BARS	50 BARS



ANTUS

OPTIONS



115 VOLT
or
220 VOLT

220V MODELS CARRY ADDITIONAL COST



RIGHT
or
LEFT
HARDWIRING



ELECTRIC
or
HYDRONIC

HYDRONIC UNITS CARRY ADDITIONAL COST
AND REQUIRE VALVES SOLD SEPARATELY

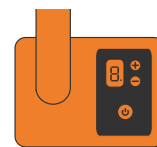

STANDARD
or
REMOTELY-WIRED

DIGITAL HEAT CONTROLLER

FINISHES



P
POLISHED

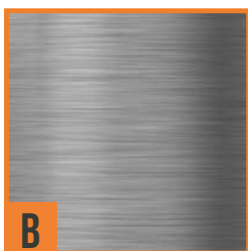

B
BRUSHED



A3256P
POLISHED
SPECIAL ORDER MODEL



SOLO COLLECTION



PLUG-IN



DRY ELEMENT
SYSTEM



FREESTANDING

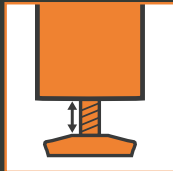

ADJUSTABLE
HEIGHT LEGS



2-YEAR LIMITED
WARRANTY



INTEGRATED
SWITCH



SOLO-33
SAFSP-33
POLISHED

The Solo Collection is an affordable, freestanding heated towel rack that requires no installation and assembles in a few minutes. Lightweight and portable, these plug-in heated towel racks are easy to move from the bathroom to the laundry room or pool area.

110 VOLT
STANDARD VOLTAGE

UP TO 149°F
BAR TEMPERATURE

10-15M
WARM-UP TIME

304-GRADE
STAINLESS STEEL

SOLO COLLECTION

	WIDTH	HEIGHT	DEPTH	WATTAGE	AMPS	BTUS	BARS	TOWELS
SAFSP-24 SAFSB-24	23 5/8"	38"	11 7/8"	150	1.35	512	10	1-2
SAFSP-33 SAFSB-33	32 1/2"	38"	15"	150	1.35	512	10	1-3



PLUG-IN CORD

Each Solo model features a 5' long cord to easily reach outlets.

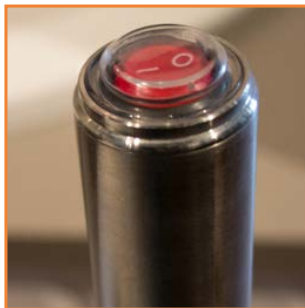

SWITCH

Integrated on/off switch illuminates when the unit is heating. Transparent, rubber boot makes the switch water resistant.

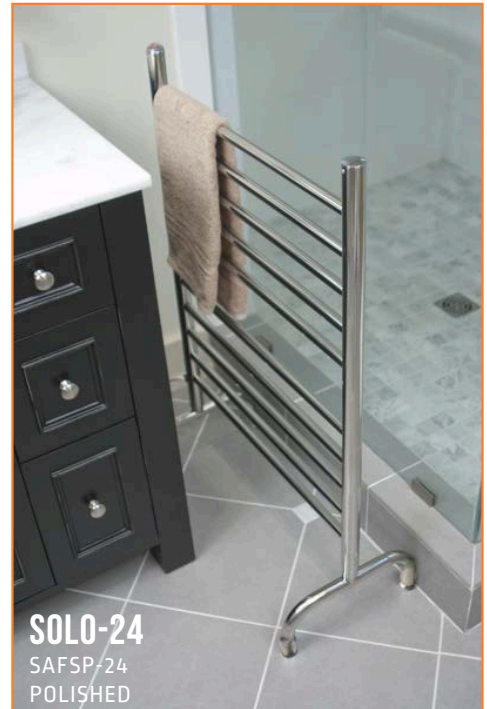

SOLO-24
SAFSP-24
POLISHED

FINISHES



P

POLISHED

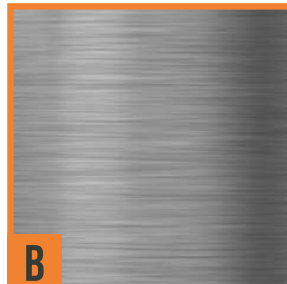

B

BRUSHED

ACCESSORIES

SOLD SEPERATELY



PLUG-IN PROGRAMMABLE TIMER

SCHEDULE ON/OFF TIMES

SKU	ATW-P24
LIST PRICE	US \$40

1 YEAR LIMITED WARRANTY

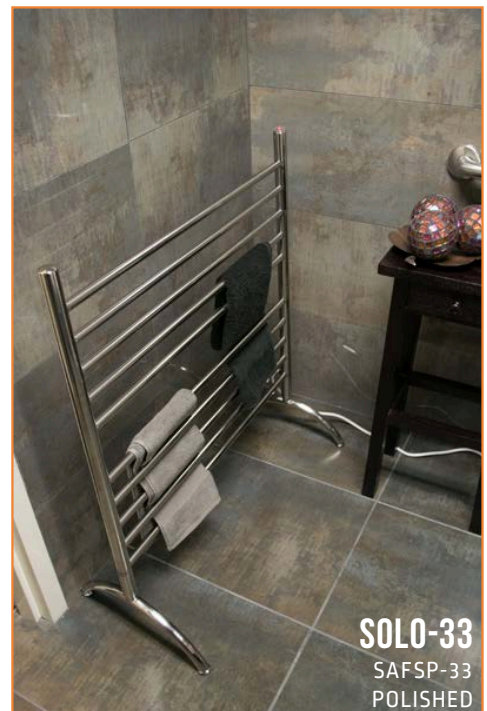

SOLO-33
SAFSP-33
POLISHED

SOLO 24

SKU	POLISHED: SAFSP-24	BRUSHED: SAFSB-24
BARS	10	
WIDTH	23 5/8"	
HEIGHT	38"	
ELECTRICAL	150 watts 1.35 amps	
BTUS	512	



US \$310



US \$370

SOLO 33

SKU	POLISHED: SAFSP-33	BRUSHED: SAFSB-33
BARS	10	
WIDTH	32 1/2"	
HEIGHT	38"	
ELECTRICAL	150 watts 1.35 amps	
BTUS	512	





SWIVEL COLLECTION

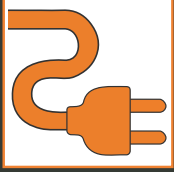

PLUG-IN

DE

DRY ELEMENT
SYSTEM

2

2-YEAR LIMITED
WARRANTY

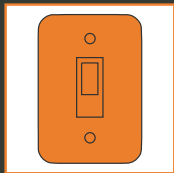

INTEGRATED
SWITCH



J-D005P
POLISHED

The unique design of the Swivel Collection is ideal for small spaces – Featuring swivel hinges allowing each bar to rotate 180° independently from the next bar. The output of these models makes them more suited to be used as drying racks rather than towel warmers.

115 VOLT
STANDARD VOLTAGE

UP TO 136°F
BAR TEMPERATURE

15–20M
WARM-UP TIME

304-GRADE
STAINLESS STEEL

SWIVEL COLLECTION



J-D005



J-D006

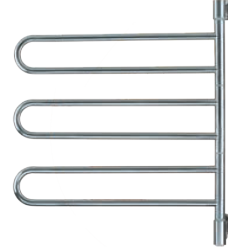

J-B003



J-B004

	WIDTH	HEIGHT	DEPTH	WATTAGE	AMPS	BTUS	BARS	TOWELS
J-D005	21 7/8"	25 1/4"	4 1/4"	50	0.45	171	5	1-2
J-D006	21 7/8"	29 1/8"	4 1/4"	60	0.55	205	6	1-2
J-B003	25"	29 1/8"	4 1/4"	54	0.49	184	6	1-2
J-B004	25"	37"	4 1/4"	72	0.65	246	8	1-2

FINISHES



P

POLISHED

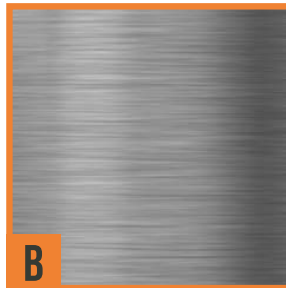

B

BRUSHED

ACCESSORIES

SOLD SEPERATELY



PLUG-IN PROGRAMMABLE TIMER

SCHEDULE ON/OFF TIMES

SKU	ATW-P24
LIST PRICE	US \$40

1 YEAR LIMITED WARRANTY



PLUG-IN CORD

Each Swivel model features a 17"-32" long pigtail cord to easily reach outlets.



INTEGRATED SWITCH

Integrated on/off switch illuminates when the unit is heating. Transparent, rubber boot makes the switch water resistant.

JACK



US \$320

J-D005

SKU	POLISHED: J-D005P BRUSHED: J-D005B
BARS	5
WIDTH	21 7/8"
HEIGHT	25 1/4"
ELECTRICAL	50 watts 0.45 amps
BTUS	171



US \$360

J-D006

SKU	POLISHED: J-D006P BRUSHED: J-D006B
BARS	6
WIDTH	21 7/8"
HEIGHT	29 1/8"
ELECTRICAL	60 watts 0.55 amps
BTUS	205

JILL



US \$330

J-B003

SKU	POLISHED: J-B003P BRUSHED: J-B003B
BARS	6
WIDTH	25"
HEIGHT	29 1/8"
ELECTRICAL	54 watts 0.49 amps
BTUS	184

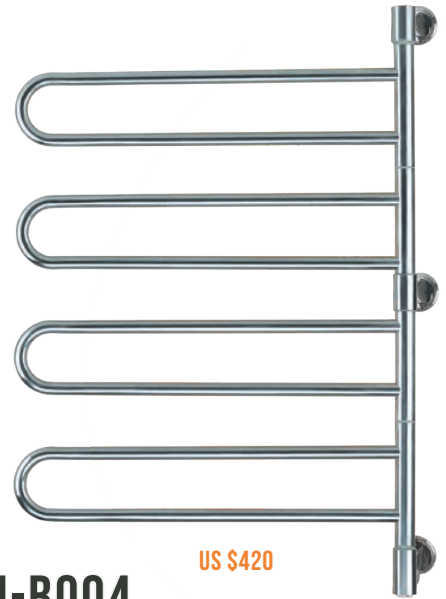

US \$420

J-B004

SKU	POLISHED: J-B004P BRUSHED: J-B004B
BARS	8
WIDTH	25"
HEIGHT	37"
ELECTRICAL	72 watts 0.65 amps
BTUS	246

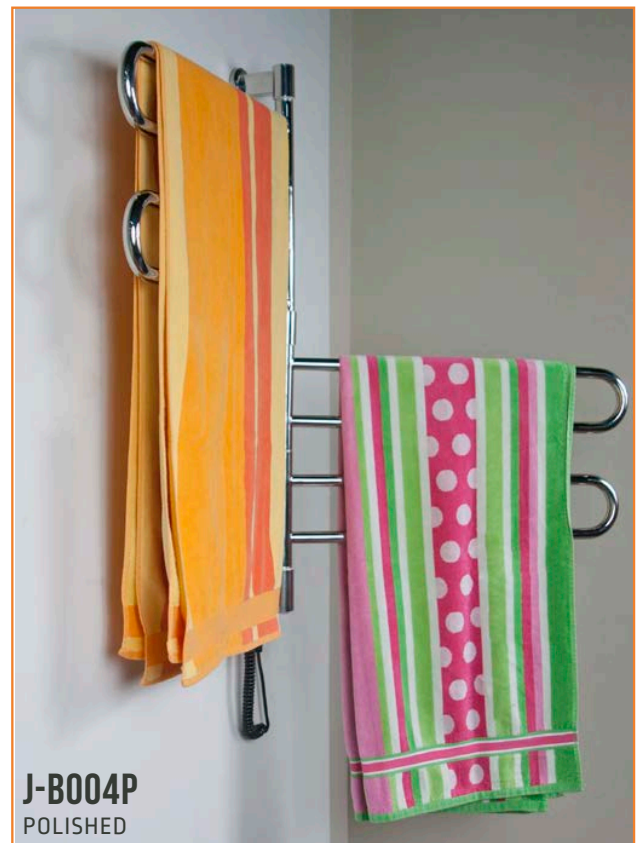
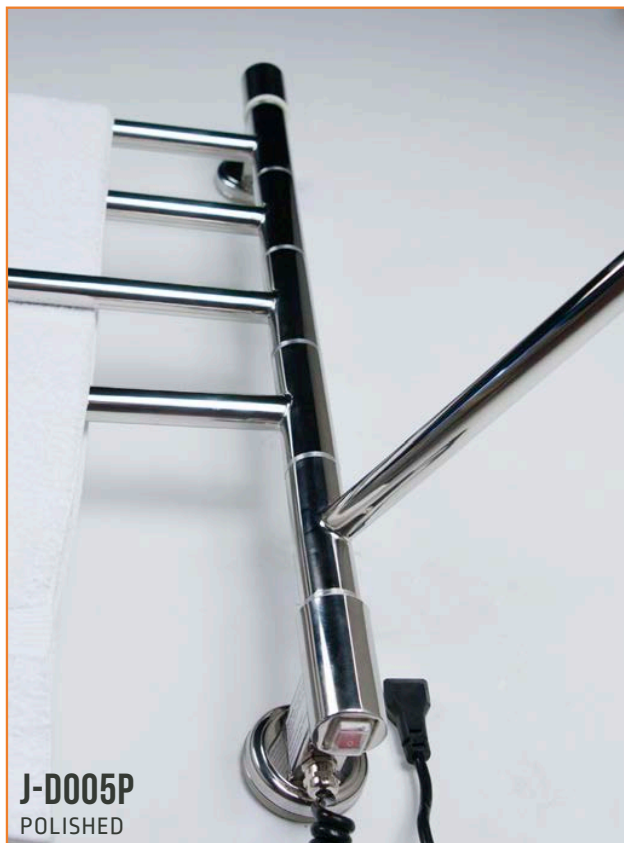



TRADITIONAL COLLECTION



HARDWIRED
ONLY



LIQUID-FILLED
SYSTEM

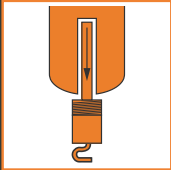

REPLACEABLE
HEATING ELEMENT



LEFT-ASSEMBLY
AVAILABLE
(EXTRA FEE)



3-YEAR LIMITED
WARRANTY

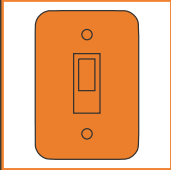

REQUIRES
SWITCH
(NOT INCLUDED)



This expertly crafted Collection features round bars with beautiful finial accents. Traditional models are nickel plated in polished or brushed finish, fitting perfectly into a traditional space. Using replaceable heating elements, these liquid-filled electric heated towel racks are efficient and reliable.

110 VOLT
STANDARD VOLTAGE

140–158°F
AVERAGE TEMP. RANGE

30–40M
WARM-UP TIME

HIGH-QUALITY
MILD STEEL

TRADITIONAL COLLECTION

FINISHES



P

POLISHED NICKEL

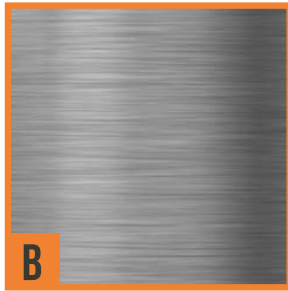

B

BRUSHED NICKEL



T2040

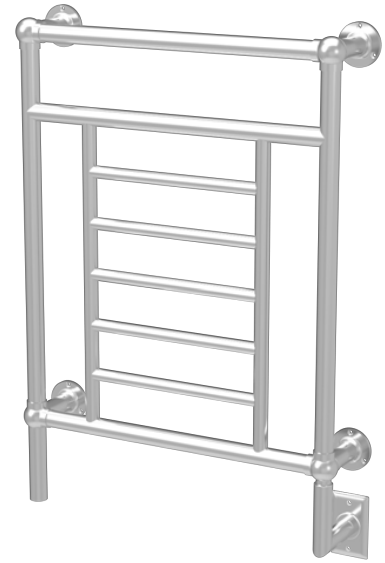

T2536

	WIDTH	HEIGHT	DEPTH	WATTAGE	AMPS	BARS	TOWELS
T2040	21"	43 1/8"	5 3/8"	150	1.8	8	1-2
T2536	25 1/4"	35 1/4"	5 3/8"	150	1.8	8	1-2

ACCESSORIES

SOLD SEPERATELY

Add additional functionality and control with our selection of accessories and controls for the Traditional Collection



DOES NOT INCLUDE COVER PLATE

**PROGRAMMABLE
TIMER**

SCHEDULE ON/OFF TIMES

SKU	ATW-T24
LIST PRICE	US \$60

5 YEAR LIMITED WARRANTY
BLACK COLOR CHANGE KIT:
ATW-T24-BL - US \$10



DOES NOT INCLUDE COVER PLATE

**COUNTDOWN
TIMER**

DELAYED SHUT-OFF

SKU	ATW-CDT
LIST PRICE	US \$60

5 YEAR LIMITED WARRANTY
BLACK COLOR CHANGE KIT:
ATW-CDT-BL - US \$10



DOES NOT INCLUDE COVER PLATE

**PILOT LIGHT
SWITCH**

SWITCH W/ INDICATOR

SKU	ATW-S-A ATW-S-W
LIST PRICE	US \$30

5 YEAR LIMITED WARRANTY

TRADITIONAL COLLECTION

STOCKED ITEMS



US \$1,150

T2040

SKU	POLISHED: T-2040PN	BRUSHED: T-2040BN
BARS	8	
WIDTH	21"	
HEIGHT	43 1/4"	
ELECTRICAL	150 watts 1.8 amps	

T2536

SKU	POLISHED: T-2536PN	BRUSHED: T-2536BN
BARS	8	
WIDTH	25 1/4"	
HEIGHT	35 1/4"	
ELECTRICAL	150 watts 1.8 amps	

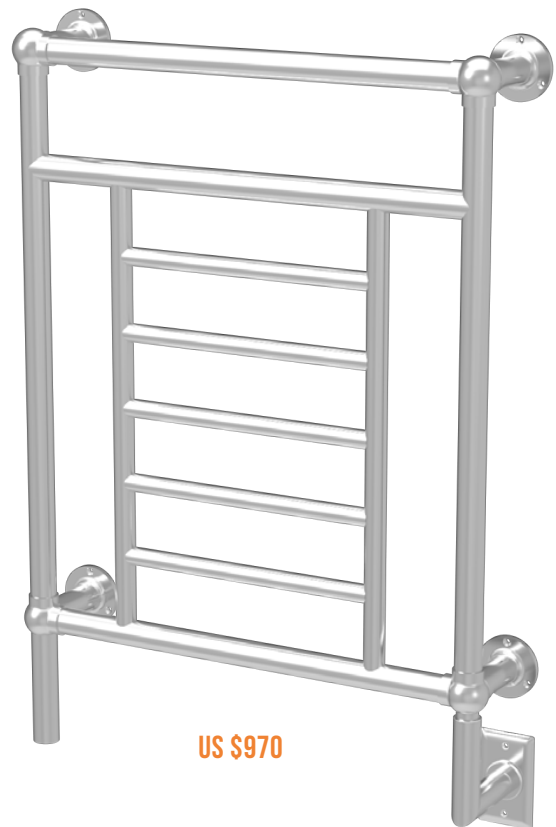

US \$970



RADIANT COLLECTION



HARDWIRED

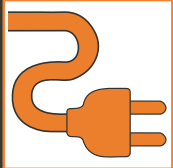

PLUG-IN

DE

DRY ELEMENT
SYSTEM

2

2-YEAR
WARRANTY



INTEGRATED
SWITCHES

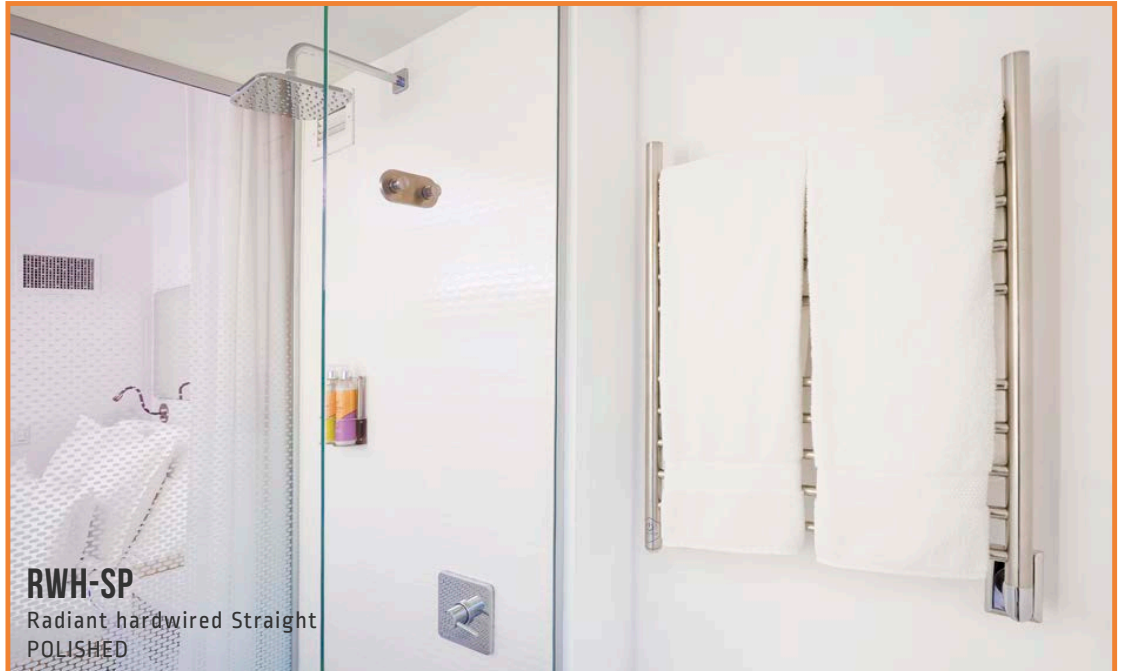

RWH-SP
Radiant hardwired Straight
POLISHED



RSH-P
RADIANT SHELF
POLISHED



RSWH-CP
RADIANT HARDWIRED CURVED
POLISHED

The Radiant Collection is one of our most popular heated towel racks — affordable and efficient. Each model includes an integrated toggle switch located at the bottom of one of the vertical bars. The 31" tall models come in both hardwired and plug-in variations for any application!

110 VOLT
STANDARD VOLTAGE

UP TO 149°F
AVERAGE TEMPERATURE

10–15M
WARM-UP TIME

304-GRADE
STAINLESS STEEL

RADIANT COLLECTION

	SKUs	WIDTH	HEIGHT	DEPTH	WATTAGE	AMPS	BTUS	BARS	TOWELS
RADIANT HARDWIRED STRAIGHT	RWH-SP RWH-SB	23 5/8"	31 7/8"	4 3/4"	150	1.3	511	10	1-2
RADIANT HARDWIRED CURVED	RWH-CP RWH-CB	23 5/8"	31 7/8"	5 3/4"	150	1.3	511	10	1-2
RADIANT PLUG-IN STRAIGHT	RWP-SP RWP-SB	23 5/8"	31 1/2"	4 3/4"	150	1.3	511	10	1-2
RADIANT PLUG-IN CURVED	RWP-CP RWP-CB	23 5/8"	31 1/2"	5 3/4"	150	1.3	511	10	1-2
RADIANT SQUARE HARDWIRED	RSWH-P RSWH-B	23 5/8"	31 1/2"	4 3/4"	150	1.3	511	10	1-2
RADIANT SQUARE PLUG-IN	RSWP-P RSWP-B	23 5/8"	31 1/2"	4 3/4"	150	1.3	511	10	1-2
RADIANT SHELF	RSH-P RSH-B	23 5/8"	19 1/8"	14"	110	1.1	511	8	1-2
RADIANT LARGE HARDWIRED STRAIGHT	RWHL-SP RWHL-SB	23 5/8"	41 3/8"	4 3/4"	150	1.3	511	12	1-2
RADIANT LARGE HARDWIRED CURVED	RWHL-CP RWHL-CB	23 5/8"	41 3/8"	5 3/4"	150	1.3	511	12	1-2
RADIANT LARGE HARDWIRED SQUARE	RSWHL-P RSWHL-B	23 5/8"	41 3/8"	4 3/4"	150	1.3	511	12	1-2

FINISHES

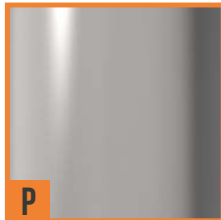

P

POLISHED

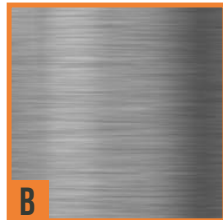

B

BRUSHED



INTEGRATED ON/OFF SWITCH

Allows complete control of the unit with the integrated illuminating on/off switch

ACCESSORIES

SOLD SEPERATELY

Add additional functionality and control with our selection of accessories and controls for the Radiant Collection Heated Towel Racks.



DOUBLE GANG PLATE

SKUS	AJ-DGP-P AJ-DGP-B
LIST PRICE	US \$20



DOES NOT INCLUDE COVER PLATE

PROGRAMMABLE TIMER

SCHEDULE ON/OFF TIMES

SKU	ATW-T24
LIST PRICE	US \$60

5 YEAR LIMITED WARRANTY
BLACK COLOR CHANGE KIT:
ATW-T24-BL - US \$10



DOES NOT INCLUDE COVER PLATE

COUNTDOWN TIMER

DELAYED SHUT-OFF

SKU	ATW-CDT
LIST PRICE	US \$60

5 YEAR LIMITED WARRANTY
BLACK COLOR CHANGE KIT:
ATW-CDT-BL - US \$10



PLUG-IN PROGRAMMABLE TIMER

SCHEDULE ON/OFF TIMES

SKU	ATW-P24
LIST PRICE	US \$40

1 YEAR LIMITED WARRANTY

RADIANT COLLECTION

STOCKED ITEMS



US \$370

RADIANT HARDWIRED STRAIGHT

SKU	Polished: RWH-SP Brushed: RWH-SB
BARS	10
WIDTH	23 5/8"
HEIGHT	31 7/8"
ELECTRICAL	150 watts 1.3 amps



US \$370

RADIANT HARDWIRED CURVED

SKU	Polished: RWH-CP Brushed: RWH-CB
BARS	10
WIDTH	23 5/8"
HEIGHT	31 7/8"
ELECTRICAL	150 watts 1.3 amps



US \$440

RADIANT SQUARE HARDWIRED

SKU	Polished: RSWH-P Brushed: RSWH-B
BARS	10
WIDTH	23 5/8"
HEIGHT	31 1/2"
ELECTRICAL	150 watts 1.3 amps



US \$310

RADIANT PLUG-IN STRAIGHT

SKU	Polished: RWP-SP Brushed: RWP-SB
BARS	10
WIDTH	23 5/8"
HEIGHT	31 1/2"
ELECTRICAL	150 watts 1.3 amps



US \$310

RADIANT PLUG-IN CURVED

SKU	Polished: RWP-CP Brushed: RWP-CB
BARS	10
WIDTH	23 5/8"
HEIGHT	31 1/2"
ELECTRICAL	150 watts 1.3 amps



US \$370

RADIANT SQUARE PLUG-IN

SKU	Polished: RSWP-P Brushed: RSWP-B
BARS	10
WIDTH	23 5/8"
HEIGHT	31 1/2"
ELECTRICAL	150 watts 1.3 amps

RADIANT COLLECTION

STOCKED ITEMS



US \$490

RADIANT LARGE HARDWIRED STRAIGHT

SKU	Polished: RWHL-SP Brushed: RWHL-SB
BARS	12
WIDTH	23 5/8"
HEIGHT	41 3/8"
ELECTRICAL	150 watts 1.3 amps



US \$490

RADIANT LARGE HARDWIRED CURVED

SKU	Polished: RWHL-CP Brushed: RWHL-CB
BARS	12
WIDTH	23 5/8"
HEIGHT	41 3/8"
ELECTRICAL	150 watts 1.3 amps



US \$550

RADIANT LARGE HARDWIRED SQUARE

SKU	Polished: RSWHL-P Brushed: RSWHL-B
BARS	12
WIDTH	23 5/8"
HEIGHT	41 3/8"
ELECTRICAL	150 watts 1.3 amps



US \$440

RADIANT SHELF

SKU	Polished: RSH-P Brushed: RSH-B
BARS	8
WIDTH	23 5/8"
HEIGHT	19 1/8"
ELECTRICAL	110 watts 1.1 amps

BOTH PLUG-IN AND HARDWIRE
KITS INCLUDED

TERMS AND CONDITIONS OF SALE

TERMS AND CONDITIONS OF SALE FOR AMBA PRODUCTS LLC (“SELLER”)

1. All products supplied are deemed to be free from manufacturing defects and in working order. Ownership is transferred on payment of the full purchase price as agreed and noted in the purchase order furnished by the buyer and confirmed by the seller.
2. Prices are quoted ex Atlanta, GA, USA and do not include shipping and handling costs (US Only). The shipping and handling costs will be agreed at time of order.
3. Net payment is due thirty (30) days from the date of shipment for credit qualifying customers. A charge will be added to the unpaid balance on all invoices not paid by the due date.
4. Seller's liability is limited to the cost of the product and does not include the cost of any other charges. Seller shall not be liable to or responsible for any consequential damages whatsoever, including but not limited to any damage or loss resulting from delay or default in delivery due to any cause.
5. Buyer expressly acknowledges and agrees that it waives any and all claims for consequential damages and/or any damages under Georgia General Laws. Seller's only liability hereunder shall be for replacement of defective goods. Replacement will be given only after Seller's inspection of the goods and its agreement to the claimed defective condition. Seller will replace product but will not accept any responsibility for installation or removal or any transport costs.
6. All claims shall be deemed waived unless made in writing and delivered to Seller within sixty (60) days after receipt by Buyer. A Guideline for Product Returns is available and needs to be followed when returning defective or damaged product.

PRODUCT WARRANTY

The seller offers a warranty for products that have been installed according to the installation instructions supplied with the product. The duration of the warranty varies depending on the product. Proof of purchase must be supplied with claim. Warranty begins 30 days from invoiced date. The warranty covers defects in workmanship and materials. This warranty is only valid for product purchased and used in the United States, Canada and Mexico.

DURATION OF WARRANTY:

HEATED TOWEL RACKS

- JEEVES Collection – 10 years.*
- QUADRO Collection – 3 years.
- SIRIO Collection – 3 years.
- ELORY Collection – 3 years.
- VEGA Collection – 3 years.
- ANTUS Collection – 3 years.
- SOLO Collection – 2 years.
- SWIVEL Collection – 2 years.
- TRADITIONAL Collection – 3 years.*
- RADIANT Collection – 2 years

*If the electric element in the Jeeves or Traditional heated towel rack is faulty it will be replaced within the first 2 years for any reason. Thereafter, elements can be replaced at a cost which is available on application. Power surges affect all electrical appliances and we cannot be held responsible beyond this period.

RETURN/WARRANTY POLICY

RETURNS

If you would like to return your item within thirty (30) days of your order ship date please contact the retailer you purchased the product from to receive an RGA (Return Goods Authorization). We will only accept a return if it is returned in the original manufacturer's packaging and has not been manipulated in any way. (The 16 AWG wire must not be damaged or cut; all assembly fittings must be in the original packaging.)

Returns of incorrectly ordered products are subject to a restocking fee. If you have ordered incorrectly, wish to order the correct product and return the incorrect product, your restocking fee will be 15%. Once the product has been received at our warehouse, it will be inspected and you will be credited for the returned product less the applicable restocking fee and original shipping and processing charges. If you choose to place a re-order the restocking fee will not be waived. The return of the product is at your expense.

If you wish to return a product but do not place a reorder, the restocking fee will be 25%. Once the product has been received at our warehouse, it will be inspected and you will be credited for the returned product less the applicable restocking fee and original shipping and processing charges. **Items returned after 90 days are subject to a 40% restocking fee or may not be returnable at all (This applies to current versions only)**

WARRANTY POLICY

If, within thirty (30) days of your order ship date, any product proves to be defective please contact your retailer immediately. Please DO NOT ship the product back to us without contacting us first and receiving an RGA (Returned Goods Authorization) Number and return instructions. We will only accept a return if it is returned in the original manufacturer's packaging. Pick up / replacement item(s) can only be sent to or picked up from the original "ship to" address. Only one pick-up attempt will be made.

Any time after the thirty-one (31) days of your order ship date, if a product proves to be defective; please contact your retailer immediately. Warranty begins 30 days from invoiced date. Please DO NOT ship the product back to us without contacting us first and receiving a RGA (Return Goods Authorization) Number and return instructions. It will be the customers' responsibility to get the product to and from Amba Products. This will be at the customer's expense. Please be sure to adequately package your product; Amba Products will not be held responsible for any damages that occurred during shipment. Once the product is received it will be properly inspected and tested.

Should we determine that the product is in fact defective, under warranty terms, it will be repaired and tested at our facility. You will be notified when your product will be ready for pickup or collection. If you choose to return the defective item, rather than replace it, we will charge a 15% restocking fee and your original shipping and processing charges will not be refunded. All transactions must take place under the original Purchase Order. This may only be done within the product warranty period. We will let you know our decision once we respond to your request.



ambaproducts.com | +1 [404] 350-9738