

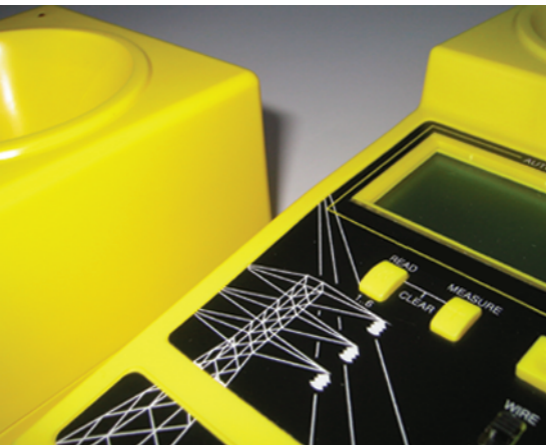

suparule

Cable Height Meter User Manual



MODELS 190, 300, 300DT, 300E, 600, 600E, DT80

| | |
|------------------------------------|----|
| Introduction | 1 |
| To make a Cable Height Measurement | 2 |
| Hints and Guidelines | 3 |
| CAL Mode | 5 |
| DT Mode | 6 |
| Trouble Shooting | 7 |
| Performance | 8 |
| DT80 | 9 |
| Using the DT80 with CHM 300DT | 10 |
| Warranty | 12 |
| Specifications | 13 |
| Ordering Information | 14 |

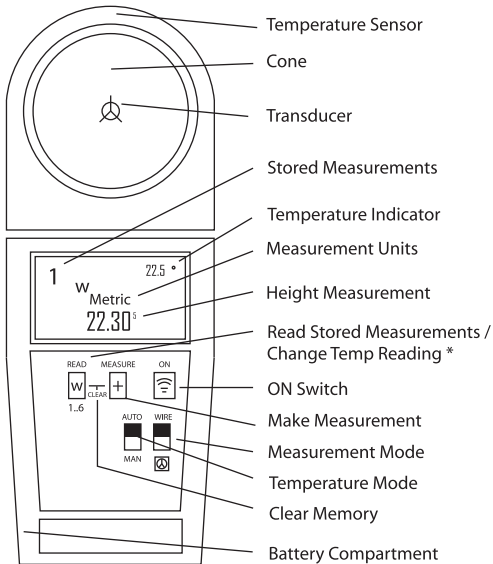

The Suparule™ Cable Height Meter is a unique, handheld instrument for measurement of cable sag, cable height and overhead clearances. It is a modern alternative to telescopic measuring poles.

The Cable Height Meter comes in three models: the CHM 190 for measuring the height of a single cable, the 300 Series for measuring the height of up to 3 overhead cables (the distance to each cable is displayed), and the 600 Series for measuring 6 cables (the distance to the lowest cable, and the difference between each cable is displayed).

The basic 190/300/300DT/ 600 models measure to a height of 15m (50ft). The 300E and 600E versions have an increased range to 23m (75ft).

The CHM 300DT, when used with the DT80, can also measure horizontal distances up to 45m (150ft)

* CHM 300 DT Model only

1. Select the required measurement units by setting the switch at the back of the unit to either M (Metric), or I (Imperial). Set the Measurement Mode switch to the WIRE position.
2. Press the ON key to power on the unit.
3. Stand directly underneath the cable(s) to be measured.
4. Allow the temperature reading to stabilise.
5. Press the MEASURE key to take a measurement. The distance to the first lowest cable is shown in the Height Measurement location in the display. If there is more than one cable present, the difference in height between each cable is stored in memory.
6. Press the READ key to display each of the stored cable height values. On the 300 Series, the distance to each cable is displayed, while on the 600 series, the distance to the first cable, and the difference between each subsequent cable is shown.

The unit will automatically switch itself off 3 minutes after the last key has been pressed.

Position the unit on the ground, directly underneath the cable to be measured. Align the unit in the direction of the cable, with the cone pointing towards the cable as shown.

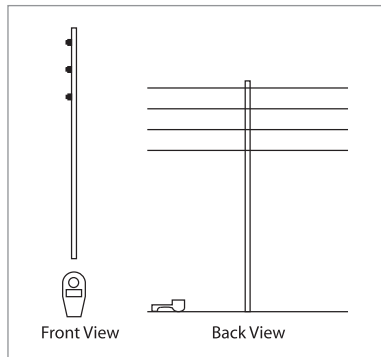

When taking wire measurements, ensure that there are no walls or buildings within a distance of 2 m (7 ft) either side of the meter, as reflections from these will distort the readings. Also ensure there are no trees or similar overhanging objects in the vicinity.

When measuring more than one wire, ensure that none of the wires are outside the sonic beam, as shown in the performance diagram on page 8.

If the wires are not vertically above one another this could be the case. In this instance it will be necessary to take a number of separate readings from different positions.

Water and moisture can cause the sensor to malfunction. Therefore, the meter should not be used in rain or snow. If water does get into the cone, leave it upside down in a dry, warm area.

If the display shows - - - - -, this indicates a “poor target” and normally happens when the cables are moving due to wind, etc. Wait until the wind dies down to get an accurate reading.

The unit operates by transmitting an ultra-sonic signal towards the wires and measuring the time it takes to pick up the echo from that signal. It automatically compensates for the fact that the speed of sound varies with temperature by monitoring the ambient temperature using the internal temperature sensor. The display continuously shows the ambient temperature reading. Because the temperature sensor reacts relatively slowly to large temperature changes, it is necessary to wait a minute or so after taking the meter suddenly from a warm to a cold environment, e.g. from inside a warm vehicle to a cold outside, before taking a measurement.

When the voltage of the battery falls below 6V,  a battery warning symbol will automatically display in the top centre of the display.

The Measurement Mode switch allows the user to periodically check the unit, to ensure that it is still operating within specification. For cable height measurement, this switch should be in the WIRE position. When the switch is put to the WALL (CAL) position horizontal measurements to large objects, e.g. walls, can be taken.

When the unit is first used, a horizontal reading to an object, e.g. wall, from a fixed position should be taken. The reading should be entered, together with the date into the table below.

Whenever the unit is to be checked for accuracy a reading should be taken from the same point, noting the result and date in the table. If the reading is outside of specification, the unit should be returned to your Suparule dealer for calibration adjustment.

| | | | | | |
|---------|--|--|--|--|--|
| Date | | | | | |
| Reading | | | | | |

The Measurement Mode switch enables horizontal distance measurement, in conjunction with the Suparule™ DT80 product. (DT stands for Dynamic Target.)

Place the DT80 at the point to where the distance is to be measured. Ensure the DT80 is facing the CHM 300DT. Switch on the DT80. Set the Measurement Mode switch on the CHM300DT to DT80 position. 

When using a tripod for the CHM300DT, the temperature sensor on the top of the CHM may be directly facing the sun, and therefore warm to a temperature considerably higher than the air temperature. In this case, it is possible to manually set the temperature reading, as follows:

Set the Temperature Mode switch to MAN. Using the Change Temperature Reading button, increment or decrement the temperature reading in the CHM display to the desired value. (Note: to alter whether this button increments or decrements, change the Temperature Mode button to AUTO, and then back to MAN).

Once the temperature is set, make the measurement as for WIRE mode, as above.

The following is a list of actions to be taken if the unit is not working properly:

Screen is blank

Check the battery is inserted correctly. Open the battery door on the bottom rear of the unit. The battery is inserted with the terminals on the inside. The + and - symbols on the battery should match the corresponding + and - symbols on the inside of the battery compartment.

Unit does not measure all wires

Ensure that horizontal distances between wires are within the sonic beam, as shown in the performance section on page 8

Incorrect readings

Ensure the Measurement Mode switch is in the correct position, i.e. WIRE for cable height measurement, and WALL for horizontal distance to object measurement.

Ensure no walls or similar obstructions are within 2 meters either side of the unit, as reflections from these can interfere with correct operation. Ensure the temperature reading has stabilised.

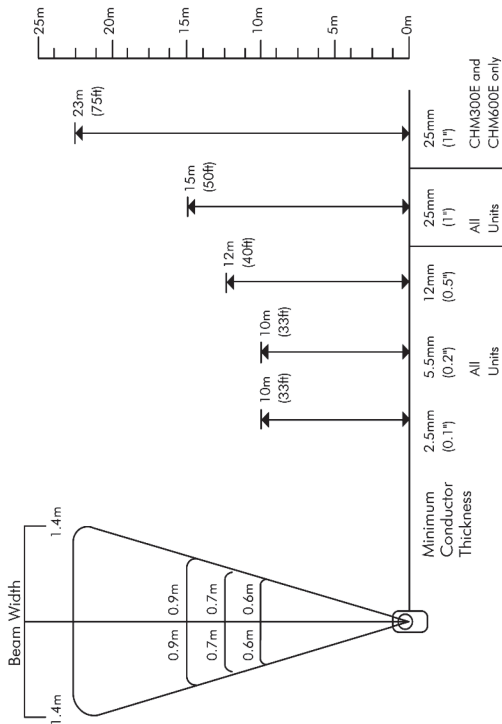

The DT80 is an accessory for use with the CHM300DT Cable Height Meter, enabling it to be used for horizontal, as well as vertical distance measurement.

On its own, the CHM300DT is used for the measurement of the height of up to 3 overhead cables, to a maximum of 15m. When used with the DT80, the CHM300DT can measure horizontal distances up to 45m.

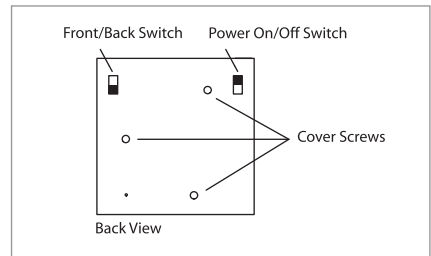
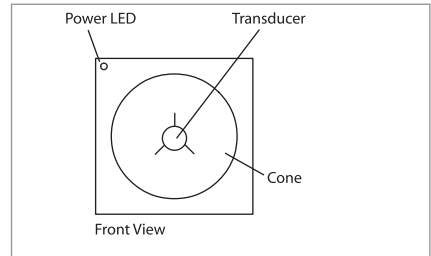

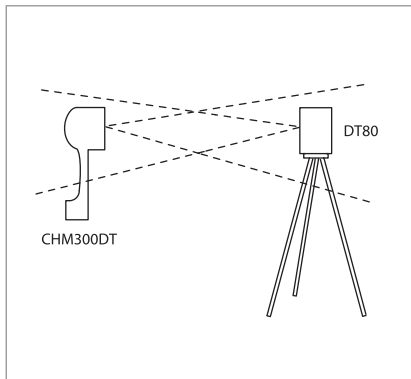

1. Position the DT at the point to which the horizontal distance is to be measured. (Both the CHM & DT can be mounted on a standard tripod if necessary, using the threaded hole at the bottom of each unit).

2. Switch on the DT80.

3. Set the Front/Back switch according to whether the measurement is to be to the front or the back of the DT.

4. Set the measurement Mode Switch on the CHM300DT to DT mode.

5. Point the cone of the CHM300DT in the direction of the DT, and press the measure button.

6. The distance to the DT will be shown on the CHM display.

7. To replace the battery, remove rear cover by removing the 3 cover screws.

Each unit is guaranteed against malfunction caused by faulty components or manufacture for a period of 24 months from date of purchase (excluding battery).

At Suparule Systems sole discretion, it will be decided either to repair, modify, or replace the unit. Should the CHM develop a fault, return the unit to your authorised dealer, with Model, Serial No., and full description of the fault.

We would like to know what you think of this product. Please contact us with any comments, criticisms or improvement suggestions, using the contact details below, or alternatively send us your comments directly at www.suparule.com Please include the serial number of the unit.

Suparule Systems Limited,
Suparule House, Holland Road,
National Technology Park,
Limerick,
Ireland.

Phone: +353 (0)61 20 10 30
Fax: +353 (0)61 33 08 12
Email: info@suparule.com
Web: www.suparule.com

| Ambient Temp = 20°C | 190 | 300/300DT | 300E | 600 | 600E | DT80 |
|---------------------------------------|---|----------------|----------------|----------------|----------------|------------------|
| Range (25mm cable min) | 3-15m(10-50ft) | 3-15m(10-50ft) | 3-23m(10-75ft) | 3-15m(10-50ft) | 3-23m(10-75ft) | |
| Range (12mm cable min) | 3-15m(10-50ft) | 3-15m(10-50ft) | 3-15m(10-50ft) | 3-15m(10-50ft) | 3-15m(10-50ft) | Enables 300DT |
| Range (5.5mm cable min) | 3-12m(10-40ft) | 3-12m(10-40ft) | 3-12m(10-40ft) | 3-12m(10-40ft) | 3-12m(10-40ft) | to measure to |
| Range (2.5mm cable min) | 3-10m(10-33ft) | 3-10m 10-33ft) | 3-10m 10-33ft) | 3-10m(10-33ft) | 3-10m 10-33ft) | 45m horizontally |
| No. of wires measured | 1 | 3 | 3 | 6 | 6 | |
| Accuracy | 0.5% ± 2 digits | | | | | |
| Resolution (range < 10m) | 5 mm | | | | | |
| Resolution (range > 10m) | 10 mm | | | | | |
| Minimum gap between wires | 150 mm | | | | | |
| Operating temperature range | -10°C to 40°C | | | | | |
| Battery life (Long Life Alkline type) | 50,000 measurements | | | | | |
| Measurement units | Imperial (feet/inches) or metric (meters) | | | | | |
| Auto power off delay | 3 minutes | | | | | |
| Dimensions | 205 x 100 x 70 mm (8.5 x 4 x 3") | | | | | |
| Weight | 0.5kg (1.1lb) | | | | | |

| Item | Order No. |
|---|------------------|
| Cable Height Meter, 1 Wire, Range 15m (50ft) | CHM190 |
| Cable Height Meter, 3 Wire, Range 15m (50ft) | CHM300 |
| Cable Height Meter, 3 Wire, Range 23m (75ft) | CHM300E |
| Cable Height Meter, 3 Wire, Range 15m (50ft) | CHM300DT |
| Cable Height Meter, 6 Wire, Range 15m (50ft) | CHM600 |
| Cable Height Meter, 6 Wire, Range 23m (75ft) | CHM600E |
| Dynamic Target, for use with CHM300DT for horizontal distances to 45m (150ft) | DT80 |
| Leather Case (protection against scratching/damage in rugged environment) | LC |

ORDERING INFORMATION



🕒 MON – FRI 8am – 4pm WST

☎ 08 9335 1718

✉ team@laserman.com.au

📍 60 Knutsford Street Fremantle WA 6160

🌐 www.laserman.com.au

 **Laserman**
TECHNOLOGIES
measuring solutions
Sales and Service Since 1997