



Z-LASER

www.Z-LASER.com

Operation manual

Products

ZA, ZB, ZD, ZF, ZPT-F, ZR, ZRG-F, ZT,
ZM12, ZM18

Declaration of CE-Conformity

We hereby confirm that the laser-light systems listed as follows meet the requirements of the directive 2004/108/EC.

Manufacturer: Z-LASER Optoelektronik GmbH, Freiburg

Types: ZA, ZB, ZD, ZF, ZPT-F, ZR, ZRG-F, ZT,
ZM12, ZM18

Variations: This declaration is valid for all product variations of the above.

The following standards were applied:

DIN EN 60825-1:2007
DIN EN 55022:2008
DIN EN 55011:2007

The following guidelines were applied:

2004/108/EC EMC-guideline
73/23/EWG Low voltage guideline

September 2010

Table of contents

Prefix: CE-declaration.....	2
Preface.....	4
Safety references.....	5
Laser classes.....	6
Index: Standard protective control measures / Table of laser classes	6
General safety instructions / Table of IP classes.....	7
Mounting of the laser into the bracket.....	8
Mounting options for line lasers.....	9
Fixing of the mounting.....	9
Line laser alignment in sawing and cutting applications.....	10
Line laser alignment in drilling applications.....	11
Cross laser alignment in positioning processes.....	12
Mountings.....	13
Auxiliary mountings.....	15
Lasers and power supply.....	16
Operating the specific lasers.....	18
Trouble shooting and elimination of simple interferences.....	21
Appendix.....	23
Index: Laser classes / IP classes.....	22/23
Power supplies.....	24
Written guarantee.....	26
Letter of guarantee.....	28

Preface

Dear customer,

we wish you a lot of enjoyment and success with this device which was developed and constructed according to the latest standard of technology. In order to operate your device in a safe, professional and economical way, we kindly ask you to read our instruction manual carefully. If you follow our instructions you can avoid dangers, reduce the cost of repairs and downtimes, and raise the reliability and lifetime of our products. If you don't use the device according to the terms of the manual there may arise dangers for the operator or others or functional impairments of the device or other material. Therefore only use the device if it is in a sound condition and only according to all the terms of the manual. Our manual contains the guidelines that are important for a proper use of the device. Only sticking to these instructions is considered appropriate usage. For errors and risks, which arise due to an inappropriate usage, the manufacturer does not take responsibility.

Before you install or operate the device, please read the manual carefully.

Appropriate usage

The **Z-LASER** was developed to save time, to use material more effectively and therefore reduce costs. Here the light red laser beam serves as a visual display. For cutting and sawing the laser marks the cutting line, for drilling it marks the drill hole position with two crossing lines. For positioning in general points, crosses, lines or other patterns like hair crosses, concentric circles or multi-lines are also possible. Nowadays laser lines are also used as measuring lines in image processing or in car body measuring.

The **Z-LASER** has an additional function in the field of safety at work. The red laser lines which indicate the cutting line or drill-hole warn the user to keep his hands off this section and can therefore avoid injuries.

Please use this „optical straightedge“ for alignment and positioning only. Any other usage is not intended - consequences resulting from an inappropriate use are borne by the operator alone.

The device is only to be used by qualified, authorized and instructed personnel. The company has to instruct every person who uses the laser device or who is working near the laser about the dangers of laser beams and a responsible use of lasers. This kind of instruction is to be repeated at least once a year.

The operator has to make sure that the manual has been fully understood. The manual has to be kept with the laser device at all times.

Testing for transport damage

Before operating the laser for the first time please check the following points:

1. Check if the package (cardboard) is undamaged.
2. Check the laser for outside damages.
3. Potential damages of the package or defects on the delivered product have to be reported to the forwarding agent or to **Z-LASER** company within 24 hours.
4. Do only send back **Z-LASERs** in the original wrapping or with an adequate cushioning of foamed material.

Safety information

Please carefully read and store the following safety notes!

- Please note the technical specifications of the laser modules.
- Do only operate laser modules with the specified operating supply voltage.
- No liability or warranty is accepted for any changes which are performed at the laser module, for example changes on electronics, manipulation of regulators, housing or the optics.
- Manipulation of laser modules can result in different output powers, so the guaranteed values may vary significantly!
- Laser can emit visible or invisible laser radiation. A warning label is attached or may be also enclosed to the laser, please view the information about the corresponding laser class!
- The following part is valid for Germany, please also follow your local safety regulations for lasers and security guidelines!
- In the accident prevention regulations for laser radiation "Laserstrahlung BGV B2" or occupational safety and health regulation to artificial optical radiation (OstrV) listed precautions must be observed. The operators of the laser equipment is responsible for the compliance with protection arrangements.
- The operation of laser devices of classes 3R, 3B and 4 need an application at the Professional Association. For this laser operation, a laser area must be marked and delineated. Also, the operator of laser devices of classes 3R, 3B and 4 need to order specially trained personnel as a laser safety officer. For the operation of laser equipment of classes 3R, 3B and 4 suitable laser safety goggles, protective clothing, or gloves must be provided by the operator.

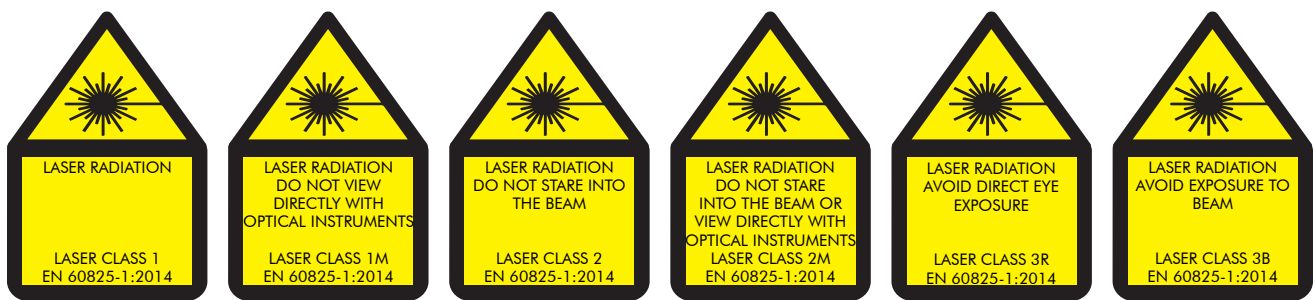

Z-LASER manufactures its products according to international standards and declares the laser classes of its products following DIN EN 60825-1). The DIN EN 60825-1 is decisive for the classification of laser equipment into laser classes, lasers are classified according to their risk in the following classes:

Laser class 1	The accessible laser radiation is harmless. LASER RADIATION
Laser class 1M	The accessible laser radiation is harmless, as long as no optical instruments are used such as magnifying glasses or binoculars. LASER RADIATION - DO NOT VIEW DIRECTLY WITH OPTICAL INSTRUMENTS
Laser class 2	The accessible laser radiation is in the visible range (400-700nm). It is safe for short-term exposure (up to 0.25s). A longer irradiation prevents the natural eyelid closing reflex. LASER RADIATION - DO NOT STARE INTO THE BEAM
Laser class 2M	As class 2 as long as any optical instruments are used, such as magnifying glasses or binoculars. LASER RADIATION - DO NOT STARE INTO THE BEAM OR VIEW DIRECTLY WITH OPTICAL INSTRUMENTS
Laser class 3R	The accessible laser radiation is dangerous for the eye. LASER RADIATION - AVOID DIRECT EYE EXPOSURE
Laser class 3B	The accessible laser radiation is dangerous to the eye, and in special cases, the skin. LASER RADIATION - AVOID EXPOSURE TO BEAM
Laser class 4	The accessible laser radiation is very dangerous for the eye and dangerous for the skin. Also diffusely scattered radiation can be dangerous. Laser radiation can cause fire or explosion hazard. LASER RADIATION - AVOID EXPOSURE TO BEAM OR DIFFUSELY SCATTERED RADIATION FOR EYE OR SKIN

Output	1mW	3mW	5mW	10mW	15mW	20mW	30mW	40mW	50mW	60mW	80mW
Dot optics											
Elliptic dot	2	3R	3R	3B	3B	3B	3B	3B	3B	3B	3B
Circular dot	2	3R	3R	3B	3B	3B	3B	3B	3B	3B	3B
Line optics (exemplary)											
Standard line, gaussian distribution, 90° fan angle	1M	1M	1M	1M	2M	2M	2M	2M	3R	3R	3B

Line optics with different lenses (e.g. Powell) may have different laser classes, as well as changing the fan angle / focussing might lead to different laser classes.

General Safety Instructions

- The lasers are only designed for operating with the voltages given in the technical data. To avoid disturbances it is **absolutely necessary** to follow these instructions. Especially spikes and other disturbances of the electric network (for example caused by switching on heavy machines) may damage the laser. If it is not certain that these conditions can be fulfilled, the input voltage needs to be stabilized by appropriate measures (primary protection / voltage stabilizer, e.g. **Z-LASER** line filter ZNF).
- High operating temperatures ($> 45^{\circ}\text{C}$ or $> 113^{\circ}\text{F}$) reduce the lifetime significantly.
- Please do not operate the laser above the given IP classes:

First code number	Second code number
Foreign objects protection	Water protection
0: Unprotected	0: Unprotected
1: Protection against large solid foreign objects > 50 mm	1: Protection against dripping water falling vertically
2: Protection against medium-sized solid foreign objects $> 12,5$ mm	2: Protection against dripping water falling at an angle of 15°
3: Protection against small solid foreign objects $> 2,5$ mm	3: Protection against spraying water
4: Protection against grain-shaped solid foreign objects > 1 mm	4: Protection against splash water
5: Protection against the ingress of dust	5: Protection against water jets
6: Dust-proof	6: Protection against powerful water jets
	7: Protection against temporary submersion
	8: Protection against continuous submersion

Example: IP64

6: Dustproof, 4: Shower water proof

Please remember: Oil and chemicals are not water! A water-jet proof laser is not necessarily protected against oil or chemicals!

IP classes

Model	ZA	ZB	ZD	ZF	ZFpeF	ZM18	ZM12
IP	64	40	40	40	40	67	67
Model	ZPT-F	ZR	ZRX	ZRG-F	Z24/-F	ZT	
IP	65	65	65	65	64	40	

7

Mounting of the laser into the bracket H0-40 / H0-20



Please unpack the laser and the mounting. If you have ordered a laser plus mounting, the mounting will be enclosed.



Move the laser carefully into the mounting. Pay attention to the stickers with the works number and the warning label. It is essential that they are not damaged.



Attention: when using the bracket H0: Please unscrew the chromed screw completely with a size 4 hex-wrench, then screw the clamping screw into the hole next to it with a size 2.5 hex-wrench, thereby spreading the mounting.



Tighten the size 4 socket screw again. For the bracket H0: Don't forget to remove the clamping screw before you tighten the socket screw.

Mounting options for line lasers

Mounting in a 45° angle
= longer beam

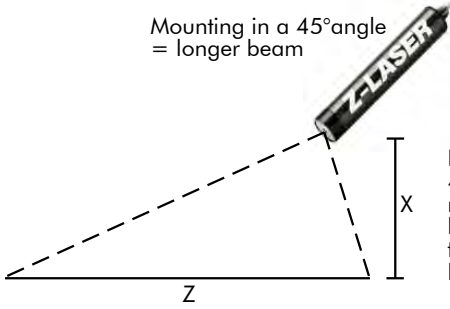

Rule of thumb for 45°-mounting:
minimum mounting height X ~ one third of the needed line length Z

Mounting perpendicular to the projection line = shorter beam

Rule of thumb:
Mounting height X ~ line length Z

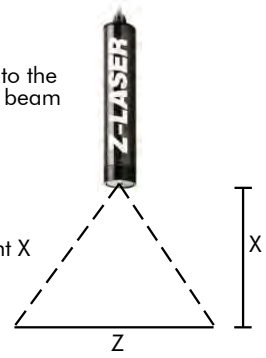

Fixing of the mounting



For mounting H0 and every other mounting which can be put onto a shaft:
Unfix socket screws, move the mounting to the required position on the shaft and tighten both socket screws.



For mounting H2 and every other mounting which can be screwed on using a slotted hole:
Put the mounting roughly into the required position and fix it with two screws through the slotted hole leaving some room to adjust the mounting. Then adjust the mounting to the exact position and tighten the screws.

Line laser alignment in sawing and cutting applications

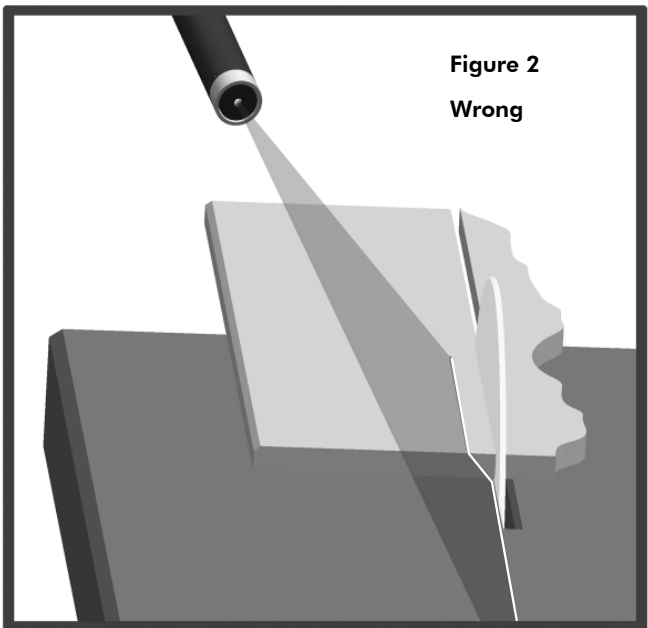
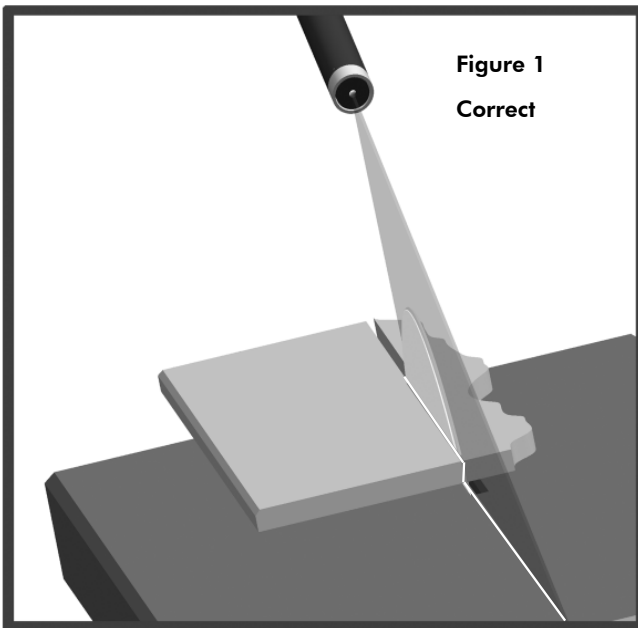

The lasers should always be mounted perpendicularly above the saw blade (see Figure 1). You can also mount the laser laterally with the laser line in continuation of the saw blade. However, if you put material onto the saw, the laser line will shift because of the difference in height due to the material and will not indicate the exact cutting course any more (see figure 2).

Hint: Make a cut as usual and leave the material there afterwards. Align the laser line exactly with the cutting edge. With the mountings H6 and H8 the laser can be adjusted very fast and exactly. Only a laser which is aligned 100 % correct will guarantee the desired success.

Line laser alignment in drilling applications

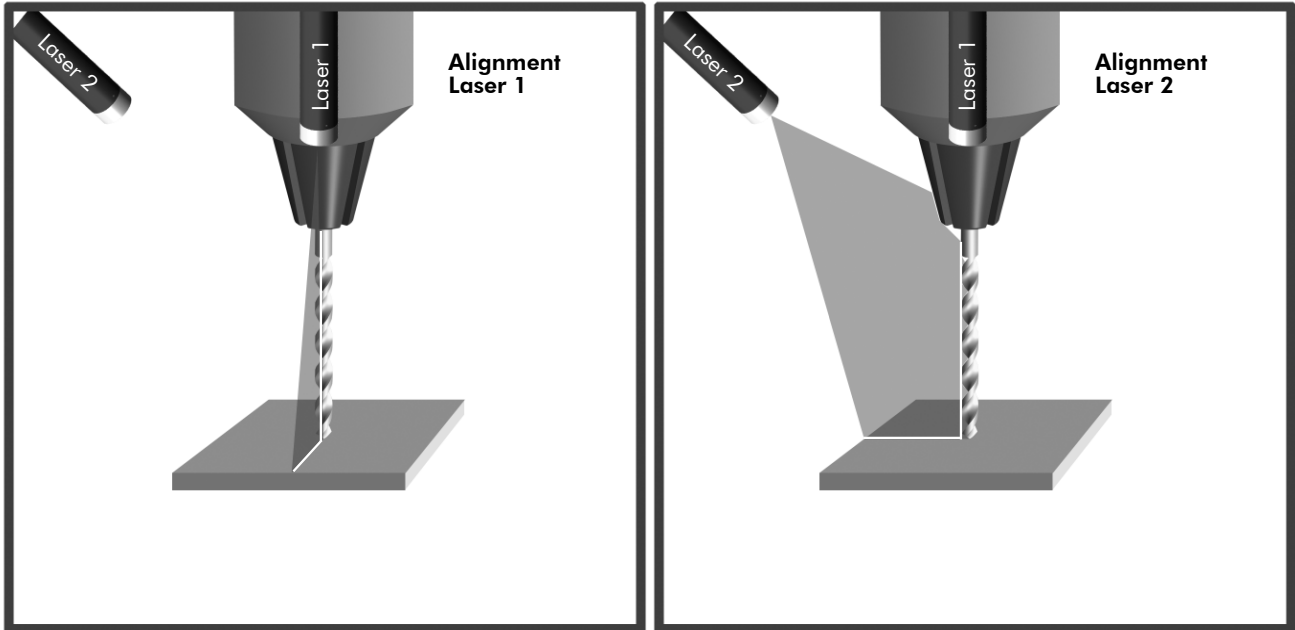

As described on page 10, the laser marking will shift due to the height of the material. To avoid this (and to ensure indicating the very spot where the drillbit actually hits the material), the two lasers need to be adjusted as follows: Each of the two laser lines has to illuminate the complete drill axis and not only one point, e.g. the drillbit.

Hint: Fix the drill in the drill chuck and align the two lasers one after the other in a way that the whole drill from the peak to the drill chuck will be illuminated centrally by the laser line (see figures above).

Cross laser alignment in positioning processes

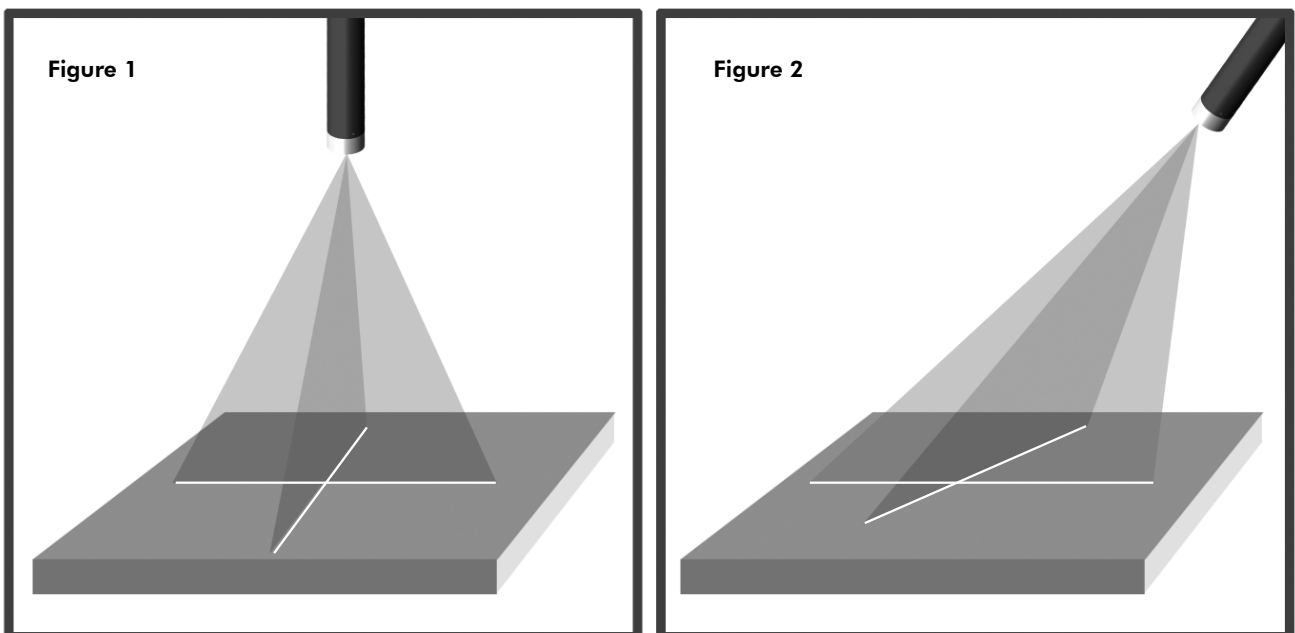

The laser should always be fixed exactly perpendicular to the work space (see Figure 1). Optionally, it is of course possible to mount the laser with an inclination (see Figure 2), but in that case you have to be aware that the angles of the laser cross might change. If you are not able to choose a vertical position because of the mounting conditions, only tilt the laser parallel to any of the edges of the right-angled work space.

Hint: Place a right angle on the work space, where the laser cross is to be projected later. Then tilt the laser in a way that the intercept point of the laser lines meets exactly the vertex of the angle. Now rotate the laser in the mounting around its axis until the laser cross matches the 90°-angle on the work space.

Mountings

With all mountings you basically have the possibility to rotate the laser inside the mounting around its longitudinal axis.



H0

After loosening the lower hexagon socket screw the mounting H0 can be fixed to a 20 mm bar, then moved parallelly and inclined. The upper part can be rotated by loosening the hexagon socket screw at the side.



H2

With the mounting H2 you can move the laser laterally by loosening the screws in the slotted hole. The upper part of the mounting can be tilted after loosening the socket screw.

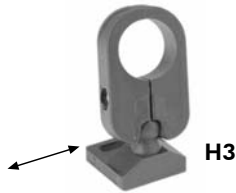

H3

With the mounting H3 the laser can be moved laterally by loosening the screws in the slotted hole. The upper part of the mounting can be rotated in nearly every direction after loosening the socket screw on the ball-shaped head joint.



HX

The mounting HX is available in PVC. With its four screws the laser can be inclined, rotated and therefore precisely aligned in any direction.

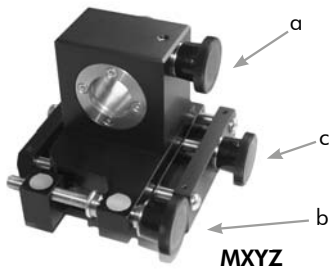

MXYZ

The precision mounting MXYZ is maintenance-free and free from backlash.
 By tightening the hexagon socket screws the laser is fixed within the mounting.
 By adjusting the screw (a) it can be rotated coaxially up to 360°.
 By adjusting the screw (b) the laser can be rotated in angles of up to 20° seen from above.
 By adjusting the screw (c) the laser can be parallelly moved up to 20mm.

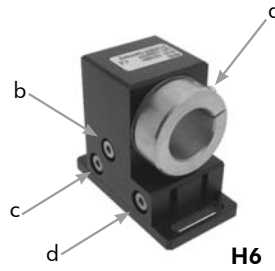

H6

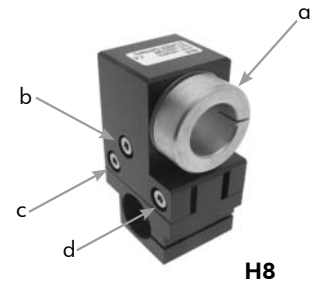

H8

With the mountings H6 and H8 a very easy and precise laser adjustment is possible.
 By tightening the hexagon socket screw (a) the laser is fixed within the mounting.
 By twisting the screw (b) it can be rotated around its own axis very exactly.
 By adjusting one of the screws (c) or (d) the laser is rotated in angles seen from above.
 By adjusting both of the hexagon socket screws together (c) and (d) the laser can be moved laterally to the left or right.



BM

The mountings H2 and H3 can be fixed to the magnet mount BM. Due to the strong magnet on the bottom side, a lifting capacity of up to 2 kg is possible.



BK

The mounting block BK can be put onto a 20mm bar. The mountings H2 and H3 can be fixed to the BK.

Auxiliary mountings

The mounting BD was developed for the attachment to walls and ceilings. The mountings H0 or H8 can be fixed to the 20 mm bar. The mounting itself is height adjustable, rotatable around 360° and laterally movable.

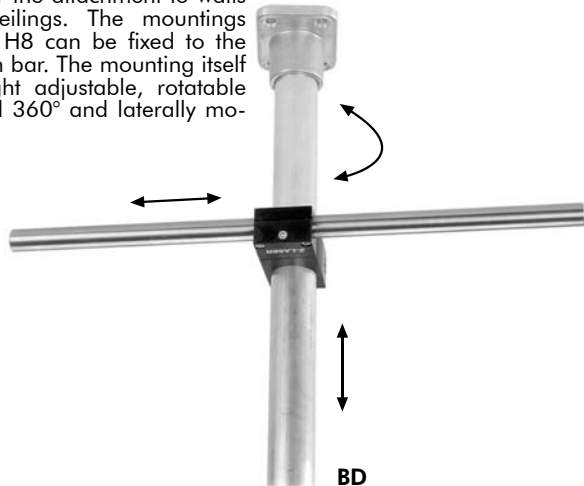

The LS is a slide rail that can be ordered in different lengths. The movable carriage LW, which is placed on that rail, can be moved to the left and right and it can be locked by using the locking bolt. On the LWs you can mount the H2, H3 and H6 mountings.

Up to four mountings H2 or H3 can be mounted on the BT mount. This kind of mounting is especially used in the textile industry.



The mounting BF can either be mounted on a trimming saw or fixed to the wall or ceiling. The mountings H0 or H8 can be fixed to the 20 mm bar.

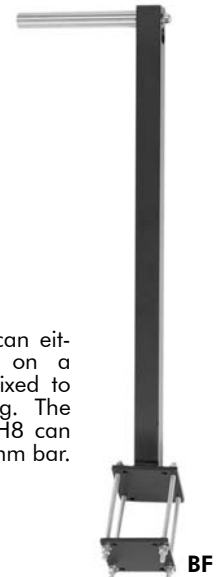

Lasers and Power Supply

Every laser has to be connected directly to the power supply system (ZPT-F, ZR, ZRX, ZRG-F) or to an enclosed mains adapter. Now it is ready to operate.

Connection plan for operating ZM18, ZM12, Z-24, Z-24F with the power supply:

M 12 Lumberg plug

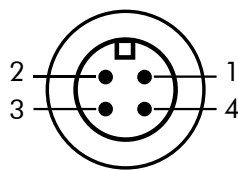

Configuration:

- 1: operating voltage +
- 2: modulation + (Z-24, ZM18S/H only)
- 3: operating voltage -
- 4: modulation - (Z-24, ZM18S/H only)



1. Wiring of the M12 plug for the laser:

- a) Unscrew the plastic housing of the M12 plug.
- b) Connect the positive and the negative cable according to the connector pin assignment! (see above)
- c) Screw the plastic housing back on the Lumberg plug and fix the cable by tightening the backside plastic cover.
- d) Put the Lumberg plug into the socket of the laser and tighten the threaded ring.

Note: The plug is to be tightened firmly but not with too much force. The use of any kind of tools for tightening the electric plug to the socket violently can lead to the damage of the laser and is considered as improper use which will lead to a loss of any warranty claim.

NG-C-W



2. Connecting the cable to the NG-C-W power supply:

DC Output

- a) The positive cable in socket +V
- b) The negative cable in socket -V
- c) DC OK (no connection)

AC Input

- a) the grounded conductor (PE) in socket
- b) the neutral conductor in socket N
- c) the phase in socket L

3. Connecting by cable

KB4

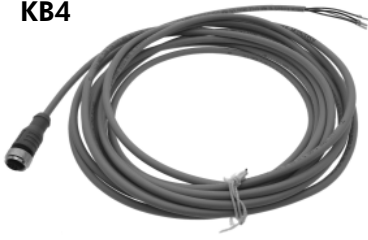

Position	Function	Colour
Pin 1	Voltage supply +	Brown
Pin 2	TTL Modulation	White
Pin 3	Voltage supply -	Blue
Pin 4	Analog modulation	Black

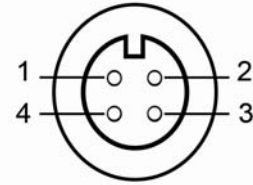

Cable with end splice



corrugated cable:
operating voltage +

round cable:
operating voltage -



Please observe the **ESD-protection measures according to IEC 61340-5-1 or ANSI/ESD S 20.20** when wiring the laser to your mains adaptor or when installing a plug. If you don't observe these rules some electronic components or the laser diode may be destroyed by electrostatic discharge. It is also possible that the laser diode is just damaged by that and will then break down completely some time after the damage.

Operating the single lasers

For the following lasers there are special possibilities:

ZA with switch option



The **ZA** is switched on and off by moving the ON/OFF switch back and forth. The switch can be removed for cleaning. Always attach the „OFF“ in beam direction, otherwise the laser does not work. The ZA operates with a mignon battery.

ZM18



ZM12



ZFpeF



The **focus*** of the lasers Z-24F, ZV, ZFpeF and ZB-pe is changed by turning the laser head.

The **focus*** of the laser ZM18 (focusable version) is changed by turning the focusing ring.

ZM12T lasers can be changed in focus with a key at the laser head. Newer ZM12 also have a focusing ring.

* You can **focus** the laser to the thinnest possible and therefore best visible laser projection.

Separate brief instruction manuals are available for **ZM18** and **ZM12** laser series.

ZPT-F / ZRG-F



ZPT-F / ZRG-F



The **focus*** of the lasers ZPT-F and ZRG-F can be adjusted by removing the protection cap and turning the inner screw with an allen key.

Please make sure to put the protection cap back on after focussing to avoid any intrusion of dust or water.

ZR, ZRG-F or ZPT-F



lens cover AK 40

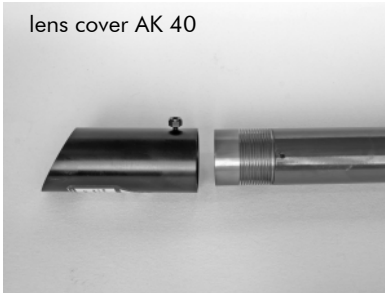

behind the cooling ribs

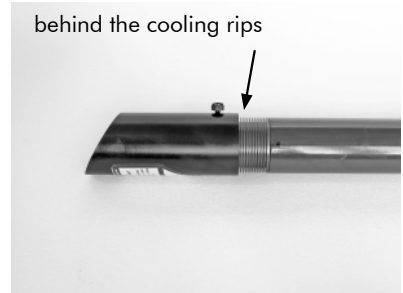

ZR, ZRG-F and ZPT-F have **asymmetrical optics**. By turning it by 180° you can move the light intensity more to the beginning or to the end of the line.

Lens covers provide extended periphery protection. Please only fasten them in the shown position, otherwise their function may be impaired.

ZT



ZT



With the ZT you can change the different optical heads by unscrewing the cap nut.

Important: Only unscrew the nut when the laser is switched off, because without its head the laser becomes class 3R!

ZT



ZT



You can change the light intensity of the ZT with the provided screw driver by turning the potentiometer inside the housing.

Trouble shooting and elimination of simple interferences

1. Error: No laser beam

Possible reasons for all lasers with mains supply:

- Is the device plugged in?
If so, is the control light on?
If not, please check whether there is mains voltage or whether the socket is defective.
- Can you rule out a broken cable?
- Additionally for the model **ZPT-F**:
Is the external fuse defective? If so, please only replace it by a fuse of the same power.
A signal (status) LED on the back of the device signals temperature problems by blinking:
 - * 1x blinking: There is a problem with the peltier device, which is responsible for the temperature exchange.
 - * 4x blinking: The inside temperature of the laser is below -30°C .
 - * 5x blinking: The inside temperature of the laser is above $+55^{\circ}\text{C}$.
 - * 6x blinking: The laser diode has a temperature above $+70^{\circ}\text{C}$.
 - * 7x blinking: The laser diode has a temperature below -30°C .

Possible causes for all lasers with wall power supply:

- Is the adapter plugged in correctly?
- Is the connector plug of the laser correctly connected to the adapter?
- Can you rule out a broken cable?
- Is it possible that the power supply for the laser is instable or nonexistant? If you suspect that this may be the cause, you can check with the voltmeter if the voltage at the exit of the mains adapter is as high as indicated. If not, please check if there is line voltage or if the socket is defective. If you have line voltage but you can't measure output voltage from the adapter, the mains adapter is defective.
- Is the adapter very hot? If so, maybe the overvoltage protection has responded to the temperature overload. In that case please do not try to fix the adapter yourself, but use another adapter.

Possible causes for lasers with battery operation:

- Battery/Accumulator existent and inserted correctly (polarity)?
- Battery/Accumulator discharged?
- Batterie case firmly screwed?
- On/Off-switch put on in the right direction? („Off“-Position to front and the small magnet (inside grey) backwards!)

If you have made sure that the malfunction is not due to any of the causes mentioned above, then either the electronics or the laser diode are defective. In that case please send the laser back to us.

21

2. Error: Laser beam split

Phenomenon: laser line can be seen but is weaker than usual and has several lines.

Please don't mistake this phenomenon for an out of focus projection! (Tests for out of focus projection: see below)

If it is sure that the laser beam is split then the diode is damaged, i.e. a new laser is necessary.

Possible reasons:

The laser diode was damaged by an instable power supply (e.g. high voltage impulses) or a short-circuit. Before replacing the laser you should check the cause!

The laser diode was damaged by electrostatic discharge (ESD). This can happen when touching the bare wires, when the cable plug is cut off or the laser was ordered with conductor sleeves only and the ESD warning label has been ignored.

So for operations where you might touch wires, always make sure that you are sufficiently ESD-protected according to EC 61340-5-1 or ANSI / ESD S20.20.

3. Error: Out-of-focus projection

Is the optics window clean?

If not, clean the window **carefully** with cotton swabs and alcohol. Please do not use strong cleaning agents and avoid scratching by pressing too strong with the cotton swab!

4. Error: The laser switches off, but then on again after a short time (only ZPT-F models)

Possible reason: the ambient temperature of the laser is too high. The integrated cooling system switches off automatically at 40° . Protect it from potential other heat sources. Don't expose the laser to direct sunlight.

Appendix

Line lengths at 45° mounting (-lg90)

Diode Power	visible line length at normal surrounding light (indoor)		optimal mounting height	
	red (635nm)	green (532nm)	red (635nm)	green (532nm)
3mW	1m		1m	
5mW	2 - 3m	4m	1,2m	2m
10mW	3 - 5m	8m	2m	3m
15mW	4 - 6m		2m	
20mW	7m	15m	3m	3m
30mW	7 - 9m		3m	
40mW	11 - 15m	20m	3m	3m
60mW		> 30m	3 - 5m	3-5m
80mW	> 20m		5m	

Other available optics

Line Cross Parallel lines Dotted line Dot matrix Square Circle Circles



Power supplies (wall-type)

WPS-5-M12 Power Supply (European & US/Japan plug) (alternative UK plug)

with 2m cable and M12 plug connector
 $V_{in} = 100$ to $240VAC$
 $V_{out} = 5VDC$ $I_{out} = 1200mA$
 ΔV_{p-p} : ca. $20mV$



WPSB-3.5 Power Supply (European, US/Japan plug) (alternative UK plug)

with 29cm cable and Texas socket
 $V_{in} = 100$ to $240VAC$
 $V_{out} = 3.5VDC$ $I_{out} = 1000mA$
 ΔV_{p-p} : ca. $50mV$



WPS-3.5 Power Supply (European, US/Japan plug) (alternative UK plug)

with 2m cable and Texas plug
 $V_{in} = 100$ to $240VAC$
 $V_{out} = 3.5VDC$ $I_{out} = 1000mA$
 ΔV_{p-p} : ca. $50mV$



VB4 Distributor box

for connecting up to 4 pcs. of laser ZB, ZD, ZF or ZT with a WPS power supply with ON/OFF switch and operation LED

Power supplies (for switch cabinet)

NG-C-W-5M Power Supply for C-track in switch cabinet

$V_{in} = 100 \text{ to } 240\text{VAC}$

$V_{out} = 5\text{VDC}$ $I_{out} = 3000\text{mA}$

$\Delta V_{p-p} = \text{ca. } 80\text{mV}$



NG-C-W-24M Power Supply for C-track in switch cabinet

$V_{in} = 100 \text{ to } 240\text{VAC}$

$V_{out} = 24\text{VDC}$ $I_{out} = 1000\text{mA}$

$\Delta V_{p-p} = \text{ca. } 150\text{mV}$



* Power supplies comply with the current EN norms

25

Written guarantee

Z-LASER products are elaborately developed and well-engineered. A systematic quality management according to DIN EN ISO 9001 accompanies the complete production process. During the production of **Z-LASER** products, a multitude of parameters (e.g. laser power, beam quality etc.) are tested for deviations from the set value and are then documented. Only products which lie within the determined set value range are released for sale. Every laser is tested again for correct functioning before it is shipped.

You will only get certified quality from us. In spite of this diligence it is possible that a device breaks down during the guarantee period.

Guarantee periods for each product family:

ZA family: guarantee for performance

ZB, ZD, ZF-/ZFpeF, ZN, ZV, ZT, ZL, Z-24, Z-24G product family: with **Z-LASER**-power supply unit 12 months, otherwise only guarantee for performance (q.v. ESD-problem)

ZR, ZRX family: 12 months guarantee

ZPT-F family: 24 months guarantee (exception: ZPT-F >20 mW with 12 months guarantee) (internal counter for hours of operation)

ZRG-F family: 12 months guarantee, but with a maximum of 2 000 hours of operation (internal counter for hours of operation)

ZM18 family: 24 months guarantee

ZM12 family: 24 months guarantee

Z-LASER warrants the product for the defined periods of time, **from the date of delivery at Z-LASER**. The warranty includes impeccable processing and functional efficiency. If deficiencies should appear in this regard, **Z-LASER** will replace or repair according to the following conditions:

1. The end user has to check the delivery immediately after the receipt and report possible damages in written form immediately, or at the latest within 2 weeks after delivery.
2. If damage already exists at the time of delivery and is noticed some time later (hidden damage), you must report this damage immediately and in written form.
3. The warranty is void,
 - if the product is installed, stored or handled incorrectly,
 - if the operating conditions with regard to supply voltage and environmental influences are not observed,
 - if the product is operated outside the given specifications,
 - if any changes to the device are made (e.g. opening, adjustment or modifications) without a written instruction by **Z-LASER**
 - if the label with the serial number has been removed, or
 - if the damage can -completely or partially- be traced back to reasons that lie outside the device, or to the fact that the device has been connected to other objects that were not suitable.

4. The guarantee includes only damages that can be traced back to material or production faults and influence the operation of the device.
5. The guarantee strictly excludes wear material.
6. **Z-LASER** does not cover consequential costs, particularly not for the loss of production, dismantling, installation or reconnection.
7. All the transport and insurance costs for returning the device to **Z-LASER** have to be paid **by the customer in advance**.
8. The warranty claim is only granted in connection with the completed and authorized letter of guarantee:

Any goods to be repaired or replaced shall be returned to Z-LASER at the customer's expense, if requested so by Z-LASER. If the goods are deemed to have a manufacturing defect within the warranty period, Z-LASER will repair or replace the goods at no charge and cover the cost of shipping them back to the customer. If it is found that the goods do not have a manufacturing defect, the customer must assume the charges for processing, dispatch and insurance, as well as the costs for the repair or the replacement of the device.

Please inform us by RMA form prior sending back laser equipment.

Further information as well as the RMA form are available online on www.z-laser.com or via e-mail rma@z-laser.de.

Letter of guarantee

The warranty claim will be granted only in connection with this completed authorized letter of guarantee:

Model: _____

Works number: _____

Accessories: _____



Stamp of **Z-LASER** representation

Please save this document!

Checked by

Z-LASER Optoelektronik GmbH • Merzhauser Str. 134 • 79100 Freiburg • Germany
Tel.: +49 / 761 / 296 44 44 • Fax: +49 / 761 / 296 44 55 • info@z-laser.de • www.z-laser.com