

Instruction Manual

MAGGIE® Magnetic Locator

Made in USA

Manufactured By
Schonstedt Instrument Company
100 Edmond Road
Kearneysville, WV 25430



60 Knutsford Street Fremantle WA 6160
Email: info@laserman.com.au | team@laserman.com.au
Phone: 08 9335 1718

Preface

The MAGGIE® Magnetic Locator is a product of over sixty years' experience in producing the world's finest flux-gate magnetometers and magnetic detectors for aerospace, military and civilian applications. The MAGGIE® incorporates the knowledge obtained from manufacturing under the most rigid quality control standards. The heart of the MAGGIE® is its patented Schonstedt HeliFlux™ magnetic field sensors. These sensors, acknowledged to be the world's finest, make possible the unequalled performance of the locator.

November 2016

Table of Contents

SECTION I: INTRODUCTION..... 3

SECTION II: OPERATING CONTROLS

 ON/ Volume 4

 OFF 4

 GAIN 4

SECTION III: VISUAL AND AUDIBLE INDICATORS

 Gain Level 5

 Battery Level 5

 Signal Strength and Polarity 5

SECTION IV: CONNECTORS AND ACCESSORIES

 Headphone Jack and Plug 6

SECTION V: BATTERY REPLACEMENT..... 6

SECTION VI: OPERATING RECOMMENDATIONS & APPLICATION NOTES

 Search Procedure 7

 Basic Signal Patterns 8

 Strongly Magnetized Markers..... 9

 Correct Stake Orientation 10

 Locating Manholes, Septic Tanks and Well Casings..... 10

 Locating and Tracing Barbed Wire 11

 Searching Areas along a Chain Link Fence 12

 Locating Valve Boxes..... 13

 Locating Cast-Iron Pipes..... 13

 Locating Steel Drums 14

 Locating Ordnance and Weapons..... 15

 Other Notes 16

SECTION VII: SPECIFICATIONS 17

SECTION VIII: TECHNICAL SUPPORT 18

SECTION IX: WARRANTY/SERVICE INFORMATION..... 18

SECTION X: PARTS DIAGRAM 19

Important Notice

Schonstedt believes the statements contained herein to be accurate and reliable; however, their accuracy, reliability, or completeness is not guaranteed.

Schonstedt's only obligation shall be to repair or replace any instrument proven to be defective within three years of purchase. Schonstedt shall not be responsible for any injury to persons or property, direct or consequential, arising from the use of any instrument.

SECTION I: INTRODUCTION

The MAGGIE® magnetic locator detects the magnetic field of ferromagnetic objects. It responds to the difference in the magnetic field between two sensors that are spaced approximately 20 inches apart. This difference is referred to as the “signal strength” throughout this manual and is represented in the instrument by an audio tone, the display of a bar graph, and a numeric indication. In addition, the polarity of the signal strength is shown as a + or – sign on the display, and determines the side (right or left) on which the bar graph is displayed. Although most objects can be located using the audio indication alone, simultaneous use of the audio and visual responses will provide additional information to help you pinpoint a target and determine its orientation.

Figure 1 illustrates an application of the MAGGIE® locator in which it is used to detect an iron marker of the type used for property line identification. As shown, the magnetic field of the iron marker is stronger at sensor A than it is at sensor B. This creates a signal strength that is larger than zero, (which would occur when the field strength is the same at both sensors).

The audio response of the MAGGIE® is designed so that the frequency of the audio tone increases as the detected signal strength increases. As a result, the frequency of the audio output is higher than the idling frequency (~ 30 Hz) which exists when the signal strength is approximately zero. This larger signal strength also causes the bar graph display to peak in either the positive or the negative direction.

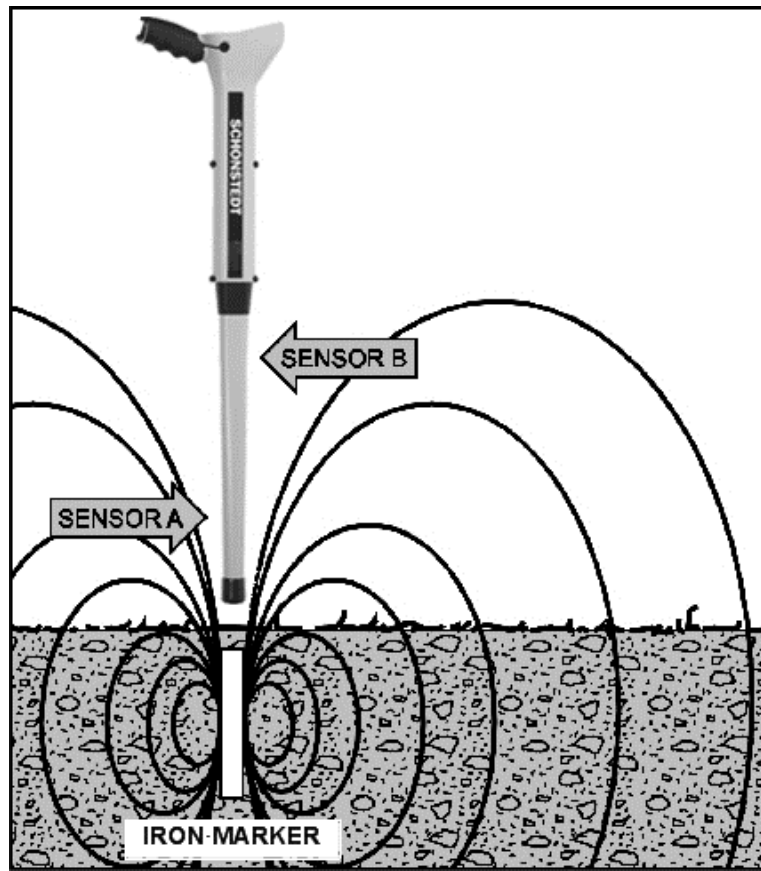



Figure 1: Detecting the Magnetic Field of an Iron Marker

SECTION II: OPERATING CONTROLS

ON/ Volume (): To turn the unit on, push this button. Upon turn on, the volume defaults to HIGH. Pushing the button a second time changes the volume to MEDIUM. Pushing the button a third time MUTES the volume. Additional pushes of this button cycle the volume through HIGH-MEDIUM-MUTE.

OFF: To turn the unit off, push this button.



GAIN ( / ): The sensitivity of the unit can be increased (to detect smaller objects at greater depths) or decreased (to detect larger objects at smaller depths) by adjusting the gain up or down pushing the UP or DOWN arrow buttons.



Figure 2: MAGGIE® Face Plate

SECTION III: VISUAL AND AUDIBLE INDICATORS

Gain Level Indicator: The gain range is indicated by a 4-segment LCD as shown in Figure 3; L (Low), M (Medium), H (High) and XH (Extra High). Upon turn on, the gain defaults to M (Medium). Each press of the UP or DOWN arrow buttons will cause the gain level indicator to change accordingly.

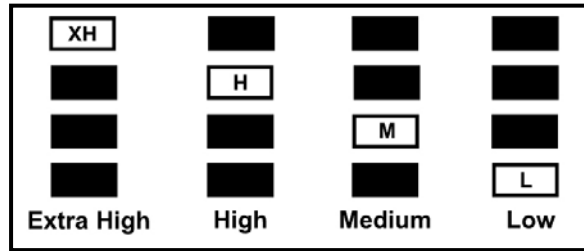

Figure 3: Gain Level Indicators

Battery Level Indicator: The battery level is indicated by a 4-segment LCD indicator, as shown in Figure 4. When all four segments are black the voltage level is between 100% and 75%. As the voltage decreases, the number of black segments decreases. Battery life varies with usage and the ambient temperature. Cold temperatures reduce battery life. Low temperatures may result in only two or three segments being black. This could be temporary and all segments will change to black as the temperature increases.

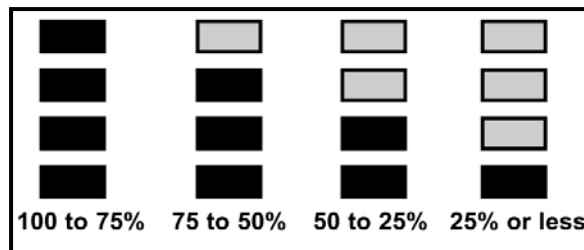

Figure 4: Battery Voltage Status Indicators

Signal Strength and Polarity Indicator: The signal strength, defined as the difference, or delta (Δ), between the magnetic field detected at the top and bottom sensors, is shown as a numerical indication in mG (milligauss) units, preceded by the polarity of the signal (+ or -), and followed by the Δ symbol, to emphasize that it represents a “difference” between the two ends of the sensor array.

In addition, the signal strength is shown in a semi-circular bar graph, with more bars indicating a stronger signal. The bar graph will switch to the + (right) or - (left) side, depending on polarity. Finally, the signal strength is also indicated by the frequency of the audio signal, a higher audio frequency indicates a stronger signal. Figure 5 shows the various visual indications of signal strength and polarity.

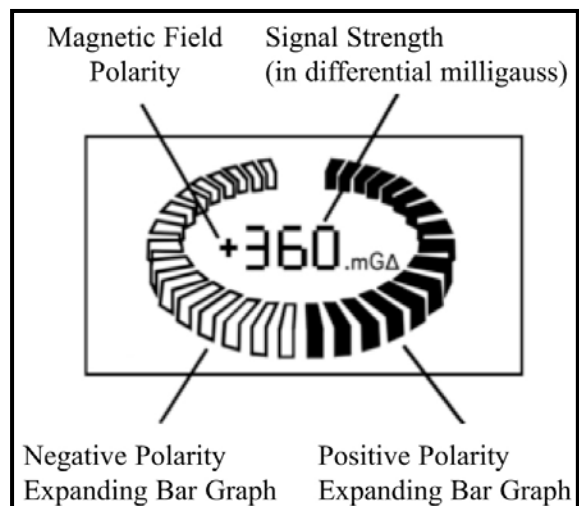

Figure 5: Signal Strength Visual Indicators

SECTION IV: CONNECTORS AND ACCESSORIES

Headphone Jack: The headphone jack is located on the side of the unit near the face of the locator. Headphones are optional, and may be purchased from Schonstedt as an accessory. The headphone jack is monaural. Standard stereo headphones available from many sources can be used, but they will produce sound in only one ear. When the headphones are plugged in, the speaker sound will be muted, but the ON/Volume button still controls the volume of the headphones.



Figure 6: Headphones

Headphone Jack Plug: A Headphone/Earphone Jack Plug has been included with this product. It is recommended that the plug remain inserted into the jack any time that headphones are not in use. This aids in making the instrument more water-resistant.



Figure 7: Headphone Jack Plug

SECTION V: BATTERY REPLACEMENT

The MAGGIE® is powered by one 9-volt disposable battery. The battery is located in the handle of the instrument and can be accessed by turning the screw counterclockwise by hand or with the use of a screwdriver or coin. To remove the battery, simply tilt the unit so that the handle is pointing down, and the battery will slide out. When replacing the battery, look at the outside of the battery door for the proper battery orientation. As a safety measure the unit will not turn on if the battery is not inserted correctly. You should never have to force the battery door closed. If the battery does not seem to be going in all the way, remove the battery, reverse its orientation and then replace it.



Figure 8: View of Battery Door and Compartment

SECTION VI: OPERATING RECOMMENDATIONS AND APPLICATION NOTES

Search Procedure

Turn the instrument ON, the gain defaults to Medium (M). Grasp the locator as illustrated in Figure 9. Because the upper sensor is near the handle of the locator, wristwatches may produce unwanted changes in the audio signal and in the meter indications, and should be removed. Keep the locator away from your shoes since they might contain magnetic material. To obtain maximum area coverage, sweep the locator from side to side. When the locator comes within range of an iron object, the signal strength will peak, causing the frequency of the audio signal to peak, the bar graph to expand in the positive or negative direction, and the digital readout to peak as well. This is shown in Figure 10.



Figure 9: Searching with the Locator

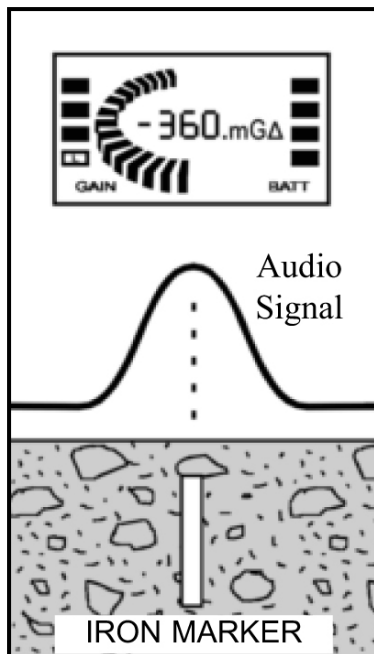

Figure 10: Illustration of Visual Indicators within Range of an Iron Object

NOTE: The number of bars shown in the bar graph, the number displayed in the digital readout, and the frequency of the audio signal will all depend on the signal strength, which is affected by the type of iron object detected, its orientation, and the gain setting.

Basic Signal Patterns

When the MAGGIE® is positioned directly over a vertical target, the signal strength will peak (audio signal, digital readout, and bar graph) at either a positive or negative polarity.

The audio signal, digital readout, and bar graph indications also peak over each end of a horizontal target. One end is positive, the other is negative. This will help you to distinguish between two vertical pipes or one horizontal pipe. Usually two vertical pipes buried in close proximity will produce bar graph indications with the same polarity.

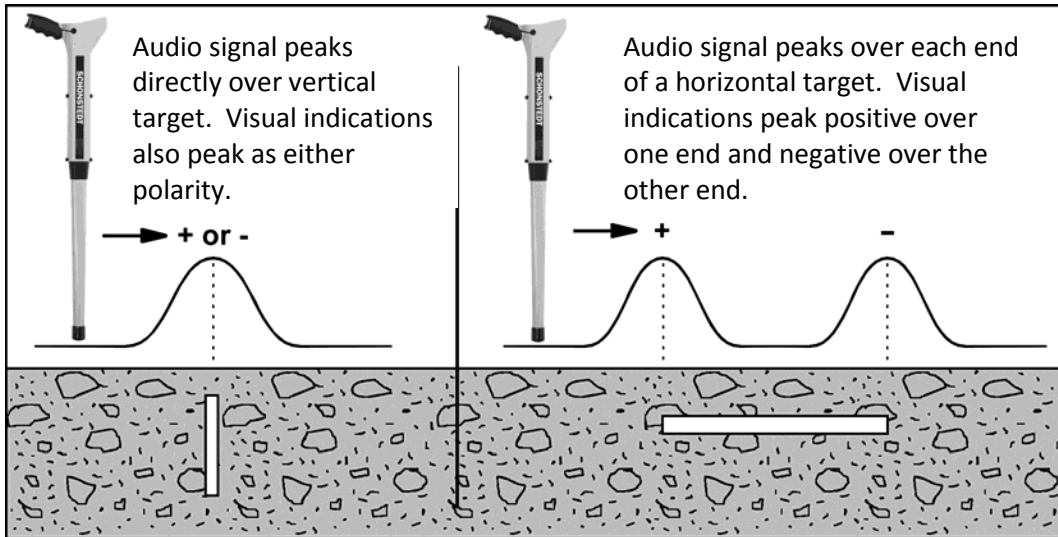

Figure 11: Signals from Vertical and Horizontal Targets

After you have detected the presence of a target, hold the locator vertically and slowly move it back and forth in an "X" pattern while listening to the audio response and observing the bar graph indicator. For a given gain setting the number of bars will be greatest when the locator is directly over a vertical target, and over the ends of a horizontal target. The "X" pattern, as shown in Figure 12, is ideal for pinpointing small objects. A 1-1/4 inch PK nail buried up to 8 inches can be located very precisely with this technique.

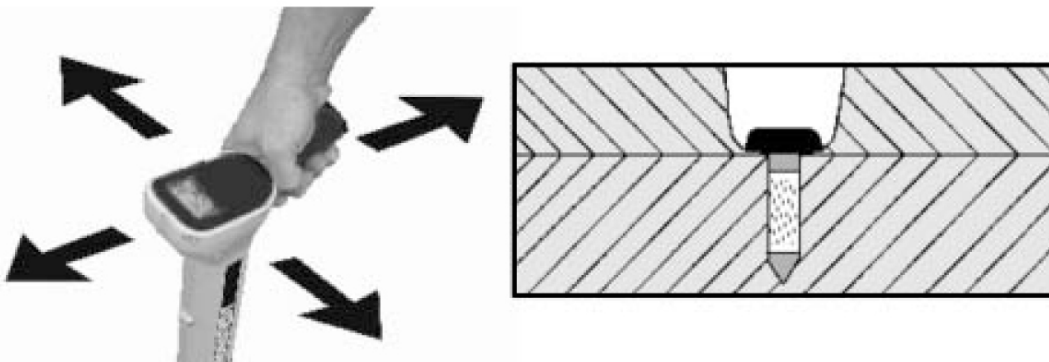

Figure 12: The "X" pattern provides precision locating.

If you are looking for a corner marker and detect two or three signals in the same general vicinity, raise the locator several inches above the ground, or decrease the gain setting before you get a shovel. Any signal that disappears when the locator is held higher, or the gain is decreased, is probably coming from a smaller target. The signal from a rusty bolt or other small item (see Figure 13) is much weaker than the signal from a larger target, such as an 18-inch length of 3/4 inch rebar which can be located at depths up to 7 feet.

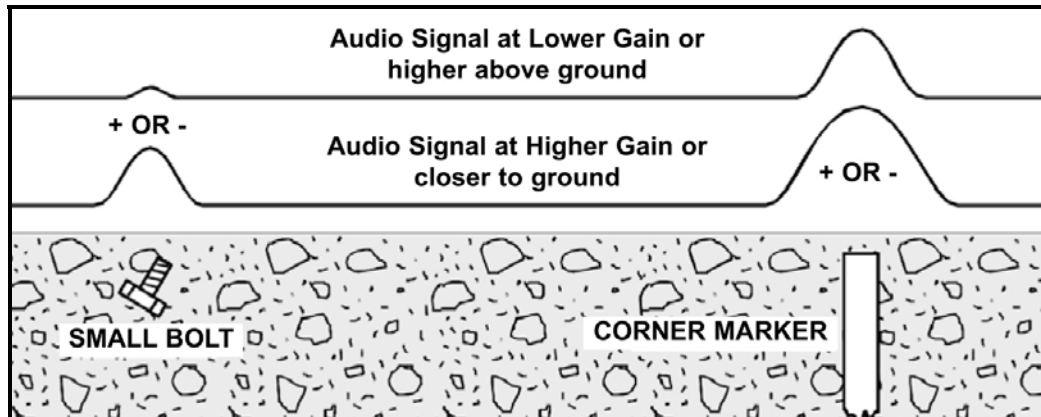

Figure 13: Decreasing the gain eliminates unwanted signals.

Strongly Magnetized Markers

A strongly magnetized marker at or near the surface provides a weaker indication on both sides of the marker that could be mistaken for the marker.

The heavy line in Figure 14 represents the increase and decrease in the audio and bar graph indications as you move the locator over a marker. Between points **A** and **B** the signals increase slightly and then decrease. Just beyond **B** the signals increase rapidly, peak directly over the marker and then decrease at point **C**. From **C** to **D** the signals increase and decrease again. So if you do not move the locator completely across the marker you might assume that the weaker indication on either side of the marker is its location. The two weaker indications occur because the locator is extremely sensitive to the magnetic field components parallel to its long axis. At points **B** and **C** the field is perpendicular to the locator so no significant audio or bar graph indications are produced at these points.

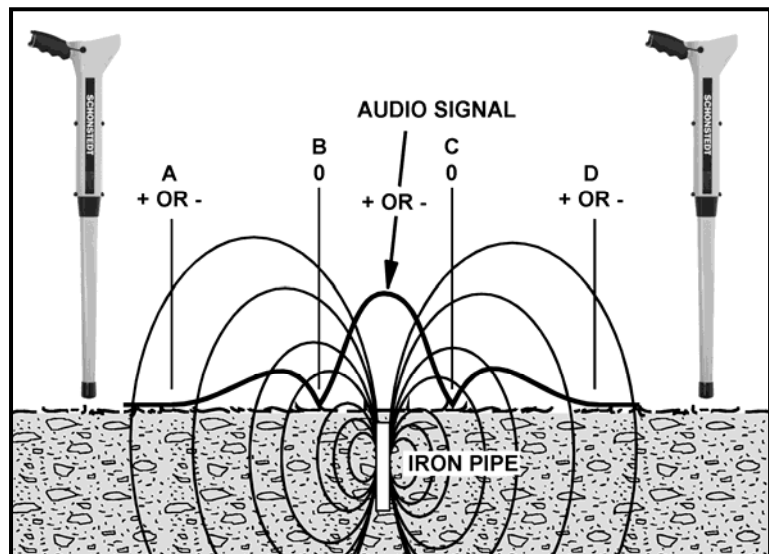

Figure 14: Signal Pattern from a Strongly Magnetized Marker

Correct Stake Orientation

When placing stakes, correct orientation is important.

For checking purposes, the orientation of the pin relative to the locator is shown in Figure 15. Check the pin with one orientation. Then rotate the pin 180°. The orientation which gives the largest reading is the one that should be used. This reading should be positive in the Northern Hemisphere, and negative in the Southern Hemisphere.

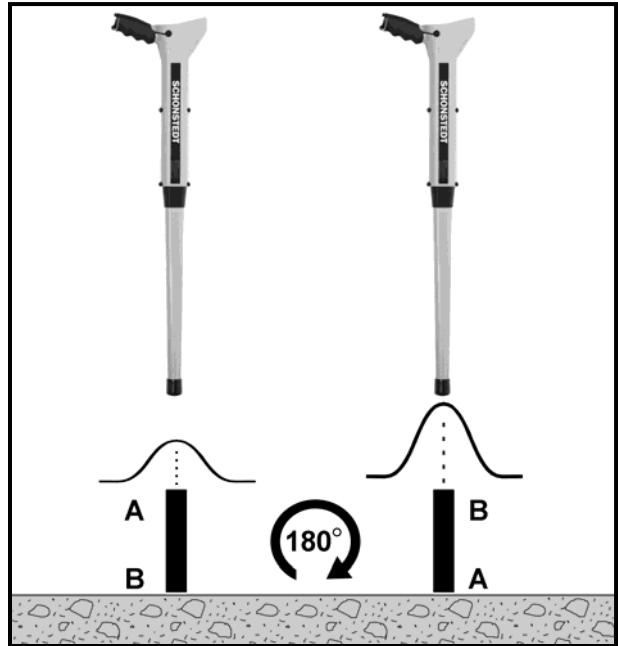

Figure 15: Checking a Stake's Orientation

An iron pin has two types of magnetization. One is the magnetization induced by the Earth's magnetic field. The induced magnetization is always downward in the Northern Magnetic Hemisphere and produces a positive output no matter which end of the stake is driven into the ground. The other type of field is the permanent magnetization which is fixed to the pin. For maximum detection, the stake should be driven into the ground such that the permanent magnetization is in the same direction as the induced magnetization.

Locating Manholes, Septic Tanks and Well Casings

The magnetic field is strongest at the edge of a shallow manhole cover. You can easily trace the edges of covers near the surface. Locating depth ranges up to 8 feet.

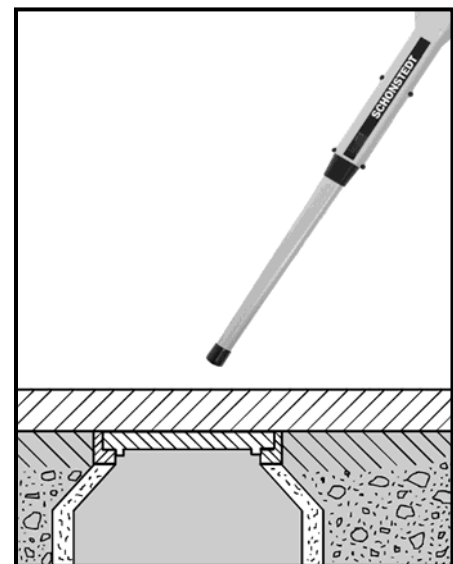

Figure 16: Locating Manhole Covers

The great length of a well casing provides a strong field at the surface that makes it easy to locate casings buried up to 15 feet deep.

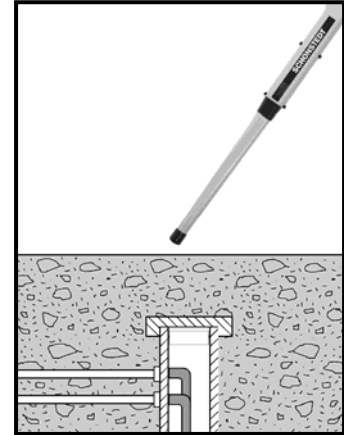

Figure 17: Locating Water Well Casings

The MAGGIE® can also be used to precisely locate the metal handles or reinforcing bars on septic tank covers at depths up to 4 feet.

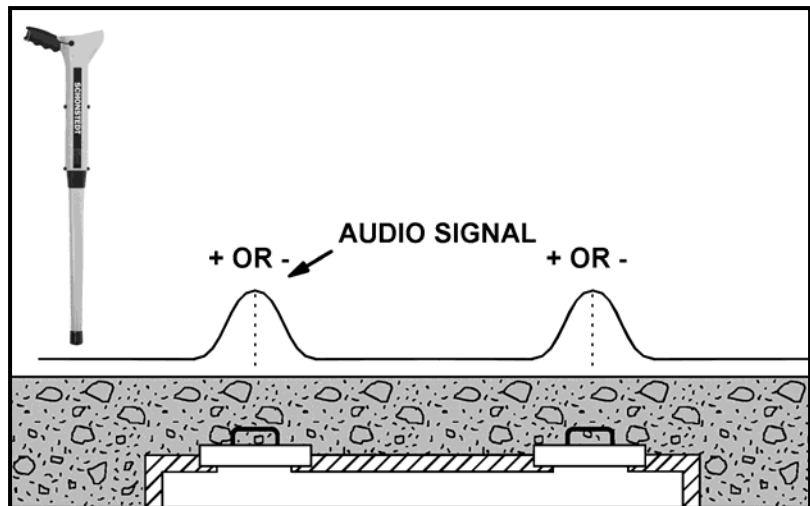

Figure 18: Signal Patterns provided by Septic Tank Covers

Locating and Tracing Barbed Wire

You can often trace barbed wire (from old fence lines) buried just beneath the surface. Even if the wire is only a trail of rust, it can still be detected near the surface. Tip the locator a little lower than usual - but not parallel with the ground.

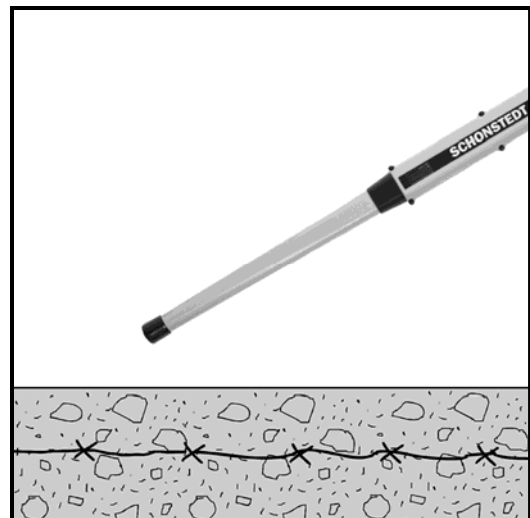
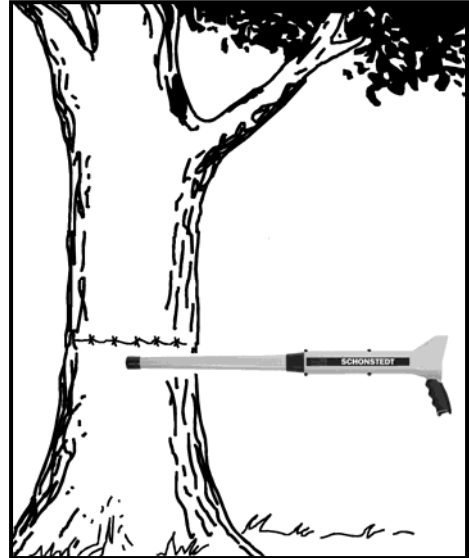

Figure 19: Tracing Barbed Wire

Examine trees for bench marks and bits of embedded barbed wire. Hold the locator parallel with the direction of the wire.

Figure 20: Tracing Pieces of Barbed Wire Embedded in Trees



Searching Areas along a Chain Link Fence

Searching in the vicinity of a chain link fence requires a reduced sensitivity setting and some control over the orientation of the locator. Position the locator horizontally with its long axis perpendicular to the fence as illustrated in Figure 21. This insures that the upper sensor is kept away from the fence.



Figure 21: Searching in the Vicinity of a Chain Link Fence

Perform the search by slowly moving the locator forward along the fence while also moving it to the right and to the left. This technique allows you to search an area several feet wide as you move forward. Listen for an abrupt drop in the signal (as shown by the null in Figure 22) that will occur when the lower sensor, located 1-1/2 inches from the end of the locator, is directly over the stake. Any variation in the position of the locator will produce an abrupt rise in the frequency of the signal.

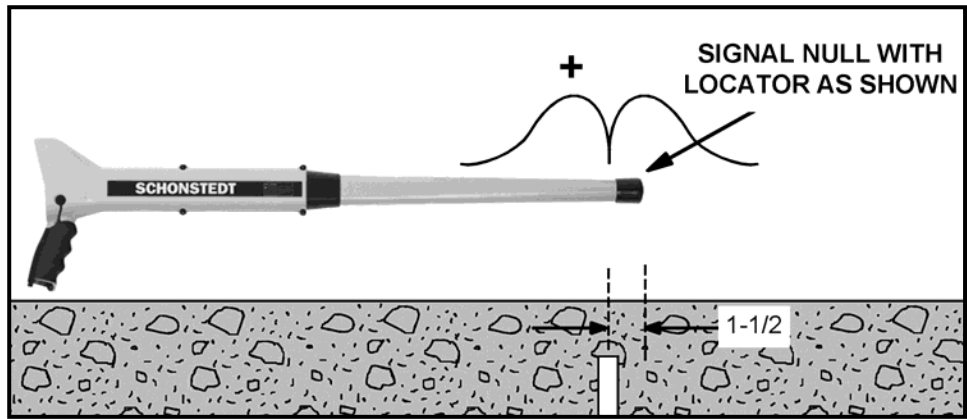

Figure 22: Abrupt Drop of Signal while Searching along a Chain Link Fence

Locating Valve Boxes

Both the valve and its casing, when iron, provide strong magnetic fields, which make them easy to locate. Plastic enclosures containing magnets (which are typically used with non-ferrous valve boxes) are easily located at depths of 6 feet or more.

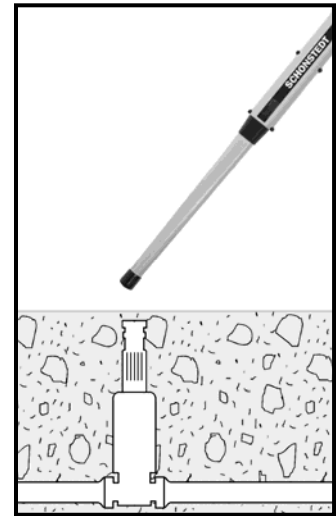

Figure 23: Locating Valve Boxes and Casings

Locating Cast-Iron Pipes

Cast-iron pipes produce the strongest magnetic signals at their joints.

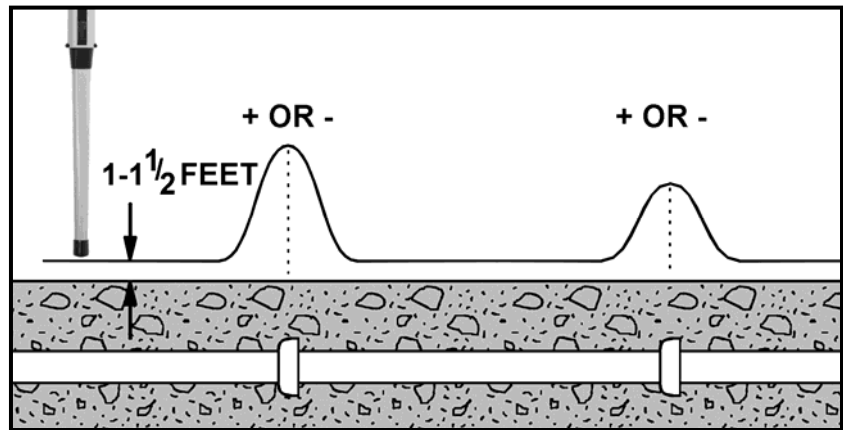

Figure 24: Signal patterns provided by Cast-Iron Pipes

After an initial sweep search identifies the general direction of the pipe, the steel pipe joints or transition points can be more accurately traced by the following procedure:

1. Set the Sensitivity control for maximum (XH indication).
2. Hold the locator vertically approximately 1 to 1-1/2 feet above the surface.
3. Walk along without turning or tilting the locator.
4. Mark the locations where the maximum signal levels occur.
5. Return to an area of maximum signal strength and hold the locator several inches above the surface. The sensitivity will probably have to be reduced during this second pass. Four-inch pipes joints and transition points can be located at depths up to 9 feet.

Locating Steel Drums

As shown in Figure 25, the MAGGIE®'s signal pattern will vary depending on the vertical or horizontal orientation of the drum and also how deep it is buried.

A fifty-five gallon drum can be located at depths up to 8 feet.

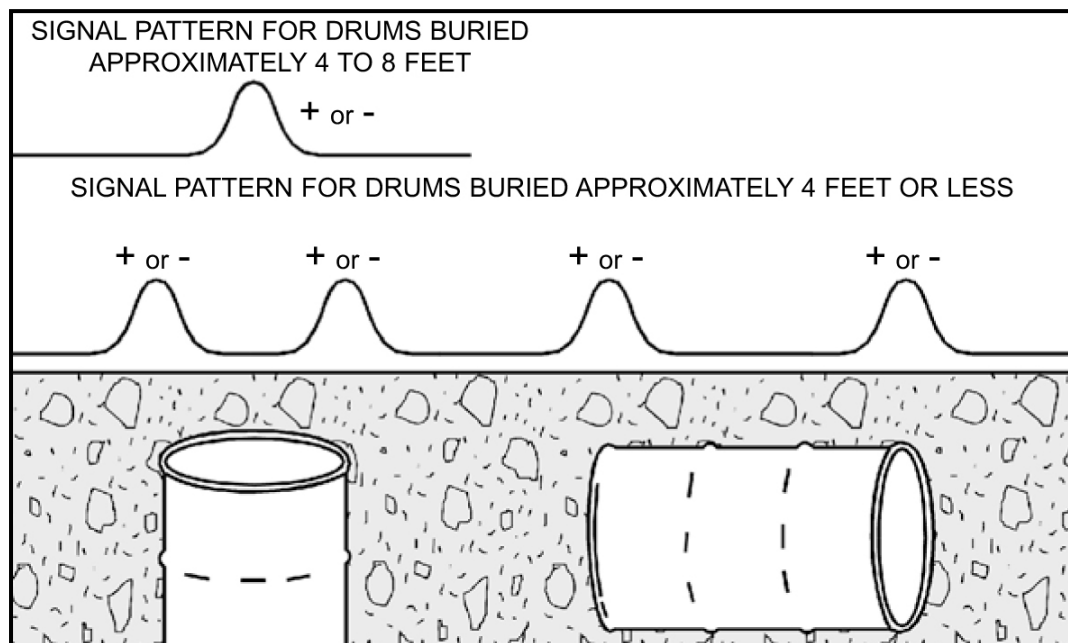

Figure 25: Signal Patterns provided by Steel Drums

Locating Ordnance and Weapons

The versatile, lightweight, cost-effective MAGGIE® is also designed to aid EOD technicians and law enforcement officers during area search operations.

Figure 26: Basic signal patterns from vertical and horizontal targets help to determine target orientation.

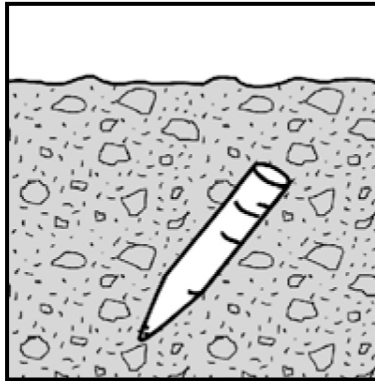
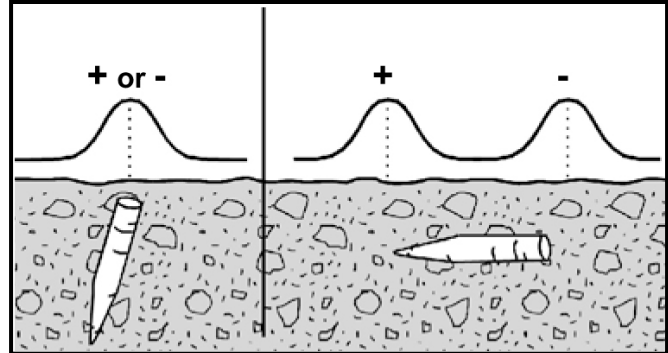

Figure 27: A 175mm projectile can be located up to 4 feet deep.

Figure 28: An 81mm mortar can be located up to 12 inches deep.

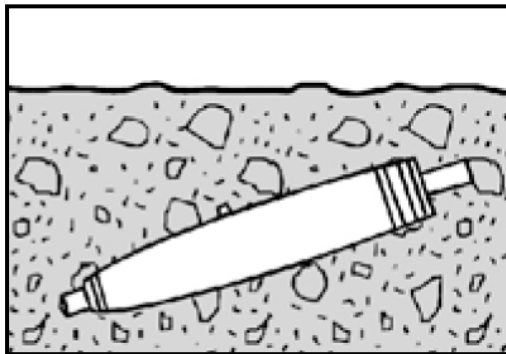
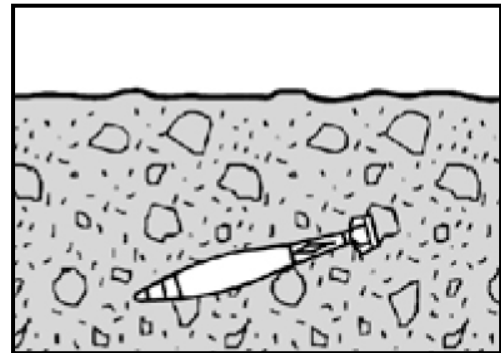
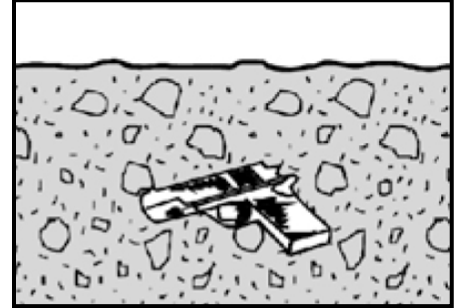

Figure 29: MK81 low drag bombs can be located up to 7 feet deep.

Figure 30: A discarded hand gun can be located up to 12 inches deep.



Other Notes

1. A burbling sound indicates the presence of an energized power line or the presence of 50/60Hz. This will not influence the meter indication unless associated with a magnetic structure.
2. The instrument will not respond to non-ferrous metals such as gold, silver, copper, brass and aluminum.

SECTION VII: SPECIFICATIONS

(Specifications subject to change without notice)

Output:	Audio: Frequency increases or decreases with signal strength (gradient field intensity). Range: 30 to 4000 Hz. Visual: Expanding bar-graphs and +/- signs indicate polarity and signal strength. Digital readout shows gradient field intensity expressed in milligauss (mG). Range: 0 to 500 mG
Battery Indicator	4-Segment LCD – 100-75, 75-50, 50-25, <25 % of battery voltage
Gain	4-Level LCD - Low (L), Medium (M), High (H), Extra High (XH)
Volume	3 Levels, Muted, Medium and Maximum
Input Power	Supplied by one 9V battery
Battery Life	24 Hours (intermittent usage)
Operating Temperature	-13° F to 140° F (-25° C to 60° C)
Water and Dust Resistance	Rated IP54, when operated with earphone jack plug (provided)
Overall Length	32.5 in (~83 cm)
Nominal Sensor Spacing	20 in (~50 cm)
Weight	Approximately 2.6 Lb. (1.2 Kg)
Construction Material	High impact ABS



This device complies with part 15 of the FCC Rules. Operation is subject to the following two conditions: (1) this device may not cause harmful interference, and (2) this device must accept any interference received, including interference that may cause undesired operation.



Application of Council Directive(s):
2004/108/EC

Standard(s) to which Conformity is Declared:
EN 61326:2013, CISPR 11:2009

SECTION VIII: TECHNICAL SUPPORT

Schonstedt offers technical support and sales support. For any reason regarding usage and application please contact our technical support team at 888-367-7014.

SECTION IX: WARRANTY / SERVICE INFORMATION

Limited Warranty:

Schonstedt Instrument Company (Schonstedt) warrants each product of its manufacture to be free from defects in material and workmanship subject to the following terms and conditions. The warranty is effective for 7 years* after the shipment by Schonstedt to the original purchaser. Please complete the warranty registration card and send back to Schonstedt Instrument Company.

Schonstedt's obligation under the warranty is limited to servicing or adjusting any product returned to the factory for this purpose and to replacing any defective part thereof. Such product must be returned by the original purchaser, transportation charges prepaid, with a description of the defect in writing. If the fault has been caused by misuse or abnormal conditions of operation, repairs will be billed. Specifically, this warranty does not cover product that has been subject to inundation by fire, water or other liquid intrusion, or units that have been damaged or compromised due to repair, alteration or modification by anyone other than an authorized repair representative. Prior to a repair being performed by Schonstedt, a cost estimate will be submitted and no work will be completed until authorized by the customer. Batteries are specifically excluded under the warranty and should be addressed to the manufacturer of batteries in question.

Schonstedt shall not be liable for any injury to persons or property or for any other special or consequential damages sustained or expenses incurred by reason of the use of any Schonstedt product.

* For Military & EOD applications, the warranty is 1 year.

Service Information:

If your locator needs service, please return it to the factory along with the following information: Name, Address, Telephone, Fax number, Where Purchased, Date, and Description of Trouble(s). An estimate will be provided prior to service work being done.

FOR SERVICE OR REPAIR

Please ship locator (in its case) to:

Laserman Technologies

60 Knutsford Street Fremantle WA 6160

or call: 08 9335 1718

or email: team@laserman.com.au

SECTION X: PARTS DIAGRAM

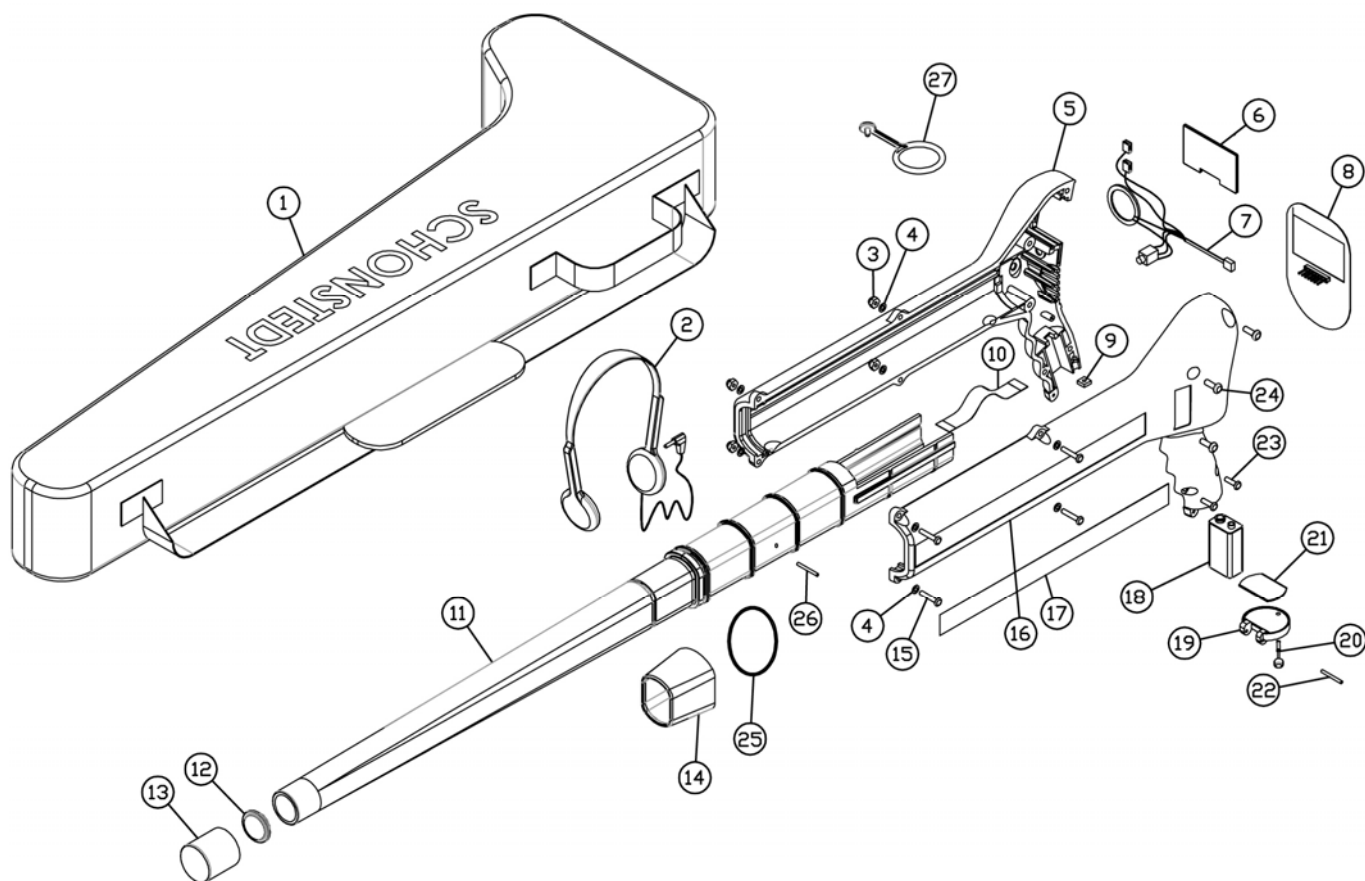

<u>Item</u>	<u>Part No</u>	<u>Description</u>	<u>Item</u>	<u>Part No</u>	<u>Description</u>
1	MA50000	SOFT CASE	15	S51113-NP	SCREW, #6-32 X 3/4
2	XT40000	HEADSET (OPTIONAL)	16	XT11200	DISPLAY HOUSING, LEFT
3	N51111	CAP NUT, #6-32	17	XT23003	SIDE LABEL, CO/PRODUCT
4	WI6P	LOCK WASHER, #6	18	B11013	BATTERY, 9V
5	XT11100	DISPLAY HOUSING, RIGHT	19	XT13101	BATTERY DOOR
6	PC11800	DISPLAY LENS	20	XT13200	CAPTIVE SCREW
7	PC11803	XTPC PIEZO ASSY	21	XT13300	GASKET
8	MA26000	MAGGIE MEMBRANE SWITCH	22	P23500	ROLL PIN, 3/32
9	N45000	SQUARE NUT, #6-32	23	S51006	SCREW, #6-32 X 1/2
10	MA11500	RIBBON CABLE	24	S51008	SCREW, #8-32 X 1/2
11	MA12100	TUBE	25	MA10004	O-RING
12	206750	END CAP	26	MA23504	BRASS PIN
13	208212	CRUTCH TIP	27	208605	XT HOUSING PLUG
14	MA11308	BOOT			