

# DEWALT®

## A WHOLE NEW LEVEL



## DEWALT® LASERS

DEWALT® LASERS CATALOGUE 2017/2018

www.**DEWALT**.com

### GUARANTEED TOUGH.®



**DEWALT**

**DEWALT**®

**SERVICE** ™



# DEWALT offers an outstanding guarantee for professional users of our lasers

## **30 DAY** NO RISK SATISFACTION GUARANTEE

If you are not completely satisfied with the performance of your DEWALT laser, simply return it to the point of purchase within 30 days for a full refund or exchange. Product must be complete as purchased and proof of purchase must be produced. Spare parts and Accessories are excluded unless failed under warranty.

## **1 YEAR** FREE SERVICE CONTRACT

If you require maintenance or service for your DEWALT laser within 12 months of purchase, you are entitled to one service free of charge, undertaken at an authorised DEWALT repair agent. Proof of purchase must be produced. Includes labour. Spare parts and Accessories are excluded, unless failed under warranty. Calibration is not included as part of our 1 year free service contract.

## **3 YEAR** LIMITED WARRANTY

In the unlikely event that your DEWALT laser becomes defective due to faulty materials or workmanship within 3 years of purchase, DEWALT guarantees to replace all defective parts free of charge or - at our discretion - replace the unit free of charge. In order to make a claim, you will need to submit proof of purchase to the seller or an authorised DEWALT repair agent.

This is provided that the product has not been misused and has been subject to fair wear and tear. Our warranty covers products purchased within Australia & New Zealand from authorised distributors. Products purchased outside of, or parallel imported into Australia or New Zealand, are not covered under our local Australia & New Zealand warranty.

Any attempt by anyone other than an authorised service repair agent to service a laser during the warranty period will invalidate the warranty for said laser. Calibration is not included under our 3 year limited warranty

For Full Terms and Conditions visit:  
[www.DEWALT.com.au](http://www.DEWALT.com.au) / [www.DEWALT.co.nz](http://www.DEWALT.co.nz)





# CROSS LINE LASERS

## DW088K-XE DEWALT® CROSS LINE LASER

A super tough self levelling cross line laser with selectable horizontal and vertical lines. Drop tested to 2m and includes a cut away face to increase ceiling coverage. Ideal for all levelling applications. Includes integrated magnetic pivot bracket.



### Cross line and return

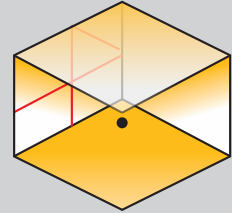

### Applications Guide

- Suspended Ceilings
- Stud Walling & Room Layout
- Kitchen / Wall Unit Installation
- General Levelling up to 50m (with detector)
- Tiling
- Interior Trim Carpentry
- Flooring & Decking

Specifications	
Type	Cross line
Levelling Type	Self
Laser Class	2
Accuracy (line)	0.3mm/m
Compensation Range	± 4°
Levelling Time	≤ 3s
Working Range	10m
Screw Thread for Adapter	1/4"
Working Range with Detector	50m
Batteries (Alkaline unless otherwise noted)	3 x AA
Battery Life (all lasers on)	20 hours
Operating Temperature	-10°C > 50°C
IP Rating	IP54



### Kit Contents

Cross line laser. Hard carry case. 3 X AA batteries. Ceiling bracket

Code	Description	Barcode
DW088K-XE	DEWALT® CROSS LINE LASER	5035048390085

# CROSS LINE LASERS

## DW088CG-XJ DEWALT® GREEN BEAM CROSS LINE LASER

Green beam version of the super tough DW088K. Selectable horizontal and vertical lines. Drop tested to 2m and includes a cut away face to increase ceiling coverage. An ideal all rounder. True green diode is 4x brighter than traditional red beam lasers. Includes magnetic pivot bracket.



### Cross line and return

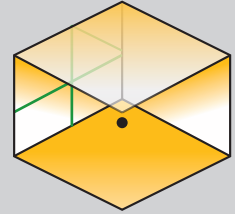

### Applications Guide

- Suspended Ceilings
- Stud Walling & Room Layout
- Kitchen / Wall Unit Installation
- General Levelling up to 50m (with detector)
- Tiling
- Interior Trim Carpentry
- Flooring & Decking

**GREEN BEAM**  
**4X VISIBILITY**



Specifications	
Type	Cross line
Levelling Type	Self
Laser Class	2
Accuracy (line)	0.3mm/m
Compensation Range	± 4°
Levelling Time	≤ 3s
Working Range	15m
Screw Thread for Adapter	1/4"
Working Range with Detector	50m
Batteries (Alkaline unless otherwise noted)	3 x AA
Battery Life (all lasers on)	20 hours
Operating Temperature	-10°C > 50°C
IP Rating	IP54



### Kit Contents

Cross line laser. Hard carry case. 3 X AA batteries.

Code	Description	Barcode
DW088CG-XJ	DEWALT® GREEN BEAM CROSS LINE LASER	5035048669600

# CROSS LINE LASERS

## DW089K-XE DEWALT® TWIN CROSS LINE LASER

Combination twin cross lines and a super bright red beam make the DW089 the tradies favourite. A tough magnesium housing protects the diodes while the micro adjustment wheel and wall mounting bracket make this laser ideal for suspended ceilings and drywall.



### 2x Cross line with plumb bob

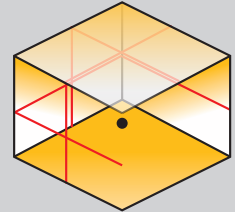

### Applications Guide

- Suspended Ceilings
- Stud Walling & Room Layout
- Kitchen / Wall Unit Installation
- General Levelling up to 50m (with detector)
- Tiling
- Interior Trim Carpentry
- Flooring & Decking

Specifications	
Type	Twin Cross
Levelling Type	Self
Laser Class	2
Accuracy (line)	0.3mm/m
Compensation Range	± 4°
Leveling Time	≤ 3s
Working Range	15m
Screw Thread for Adapter	1/4"
Working Range with detector	50m
Batteries (Alkaline unless otherwise noted)	4 x AA
Battery Life (all lasers on)	10 hrs
Operating Temperature	-10°C > 50°C
IP Rating	IP54



### Kit Contents

Cross line laser. Hard carry case. 4 X AA batteries. Ceiling bracket

Code	Description	Barcode
DW089K-XE	DEWALT® TWIN CROSS LINE LASER	5035048382165

# CROSS LINE LASERS

## DCE0822D 1G-XE DEWALT® GREEN BEAM CROSS LINE LASER WITH PLUMB – 10.8V COMPATIBLE

A rugged cross line laser that combines selectable cross lines with plumb function. Includes an integrated magnetic bracket. Uses the latest in TRUE GREEN DIODE technology to produce a beam that is 4 x brighter than traditional red beam lasers. Ideal for all levelling applications and floor to ceiling transfer work. Comes complete with a 10.8V battery and charger.



**GREEN BEAM**  
4X VISIBILITY



**1x Cross line with plumb bob**

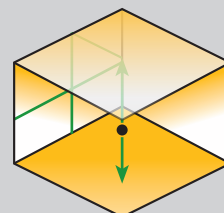

### Applications Guide

- Suspended Ceilings
- Stud Walling & Room Layout
- Kitchen / Wall Unit Installation
- General Levelling up to 50m (with detector)
- Tiling
- Interior Trim Carpentry
- Flooring & Decking
- Floor to Ceiling Transfer
- Metal Stud Wall Tracking
- Ceiling Anchor Positioning
- Plumb / Horizontal Drilling Locations For Vertical Pipe & Duct
- Downlighters



Specifications	
Type	Cross with plumb
Levelling Type	Self
Laser Class	2
Accuracy (dot)	0.2mm/m
Accuracy (line)	0.3mm/m
Compensation Range	± 4°
Levelling Time	≤ 3s
Working Range	15m (Line)/30m (Dot)
Screw Thread for Adapter	1/4"
Working Range with Detector	60m
Batteries (Alkaline unless otherwise noted)	10.8v (included)
Battery Life (all lasers on)	10 hours
Operating Temperature	-10°C > 50°C
IP Rating	IP65

### Kit Contents

Cross line laser. Hard carry case. Glasses. Target. Ceiling bracket. 10.8V 2.0Ah battery. Charger.

Code	Description	Barcode
DCE0822D 1G-XE	DEWALT® 10.8V GREEN BEAM CROSS LINE LASER WITH PLUMB	5035048667002

# MULTI LINE LASERS

## DW0811-XJ DEWALT® 360° CROSS LINE LASER

A tough self levelling laser that gives a full 360° horizontal line around the room as well as an additional vertical line for cross line applications. The supplied mini stand allows small increment height adjustments, making this laser ideal for kitchen fitting, tiling, suspended ceilings etc.



**Horizontal 360° beam with vertical line**

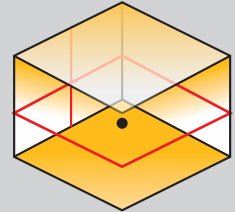

### Applications Guide

- Suspended Ceilings
- Stud Walling & Room Layout
- Kitchen / Wall Unit Installation
- General Levelling up to 50m (with detector)
- Tiling
- Interior Trim Carpentry
- Flooring & Decking
- HVAC
- Dado / Chair Rails
- Decorating

Specifications	
Type	360° + Cross
Levelling Type	Self
Laser Class	1
Accuracy (line)	0.4mm/m
Compensation Range	± 4°
Levelling Time	≤ 3s
Screw Thread for Adapter	1/4" / 5/8"
Working Range	10m (Rad.) / 20m (Dia.)
Working Range with Detector	50m
Batteries (Alkaline unless otherwise noted)	3 x AA
Battery Life (all lasers on)	8 hours
Operating Temperature	-10°C > 50°C
IP Rating	IP54



### Kit Contents

Multiline laser. Hard carry case. 3 X AA batteries. Adjustable mini stand / bracket

Code	Description	Barcode
DW0811-XJ	DEWALT® 360° + CROSS LINE LASER	5035048475942



# MULTI LINE LASERS

## DCE089LR-XJ DEWALT® 3 X 360° CROSS LINE LASER – 10.8V COMPATIBLE

A triple diode laser that emits 3 x full 360° red lines for full room coverage. Twin cross points also give plumb. Comes complete with a blank 10.8V battery pack that allows use with standard AA batteries, or for extended working life – use with a 10.8V DEWALT battery pack (available separately). Ideal for all applications.



### 3x 360° line

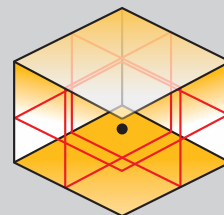

### Applications Guide

- Suspended Ceilings
- Stud Walling & Room Layout
- Kitchen / Wall Unit Installation
- General Levelling up to 50m (with detector)
- Tiling
- Interior Trim Carpentry
- Flooring & Decking
- HVAC
- Dado / Chair Rails
- Decorating
- Floor to Ceiling Transfer
- Metal Stud Wall Tracking
- Ceiling Anchor Positioning
- Plumb / Horizontal Drilling
- Locations For Vertical Pipe & Duct
- Downlighters



Specifications	
Type	Line x 3x 360°
Levelling Type	Self
Laser Class	2
Accuracy (line)	0.3mm/m
Compensation Range	± 4°
Levelling Time	≤ 3s
Screw Thread for Adapter	1/4" / 5/8"
Working Range	15m (Rad.)/30m (Dia.)
Working Range with Detector	100m (Dia.)
Batteries (Alkaline unless otherwise noted)	4 x AA / 10.8V
Battery Life (all lasers on)	14 hours
Operating Temperature	-10°C > 50°C
IP Rating	IP65

### Kit Contents

Multiline laser. Hard carry case. 4 X AA batteries. & Battery pack adaptor. Ceiling bracket

Code	Description	Barcode
DCE089LR-XJ	DEWALT® 3X360° 10.8V LASER	5035048489666

# MULTI LINE LASERS

## DCE089D1G-XE DEWALT® 3 X 360° CROSS LINE LASER – GREEN BEAM - 10.8V COMPATIBLE

A triple diode laser that emits 3 x full 360° green lines for full room coverage. Twin cross points also give plumb. Uses the latest in TRUE GREEN DIODE technology to produce a beam that is 4 x brighter than traditional red beam lasers. Comes complete with a 10.8V battery and charger and is deal for all applications.

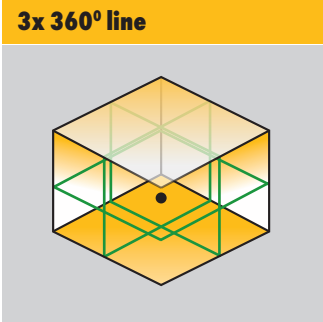

- ### Applications Guide
- Suspended Ceilings
  - Stud Walling & Room Layout
  - Kitchen / Wall Unit Installation
  - General Levelling up to 50m (with detector)
  - Tiling
  - Interior Trim Carpentry
  - Flooring & Decking
  - HVAC
  - Dado / Chair Rails
  - Decorating
  - Floor to Ceiling Transfer
  - Metal Stud Wall Tracking
  - Ceiling Anchor Positioning
  - Plumb / Horizontal Drilling Locations For Vertical Pipe & Duct
  - Downlighters

Specifications	
Type	Line x 3x 360°
Levelling Type	Self
Laser Class	2
Accuracy (line)	0.3mm/m
Compensation Range	± 4°
Levelling Time	≤ 3s
Screw Thread for Adapter	1/4" / 5/8"
Working Range	20m (Rad.) 40m (Dia.)
Working Range with Detector	100m (Dia.)
Batteries (Alkaline unless otherwise noted)	10.8V
Battery Life (all lasers on)	14 hours
Operating Temperature	-10°C > 50°C
IP Rating	IP65



**Kit Contents**  
 Multiline laser. Hard carry case. 10.8V battery & charger. Ceiling bracket. Laser glasses. Laser target.

Code	Description	Barcode
DCE089D1G-XE	DEWALT® 3 X 360 LASER – GREEN BEAM	5035048489635

# ROTARY LASERS

## DCE074NR-XJ DEWALT® 18V ROTARY LASERS – RED BEAM (BARE)

A range of new jobsite tough rotary laser levels ideal for room and site layouts. Power comes courtesy of the DEWALT® 18V battery platform and offers runtime of up to 56 hours (5Ah battery - battery sold separately). Comes complete with Tstak storage box and accessories. Drop tested to 2m. DEWALT® XR FLEXVOLT™ Compatible.



### Horizontal 360° beam with vertical spot

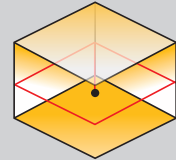

### Vertical rotary 360° beam

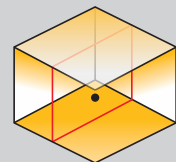

### Slope +/- 10%

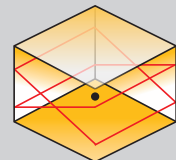

### Applications Guide

- Suspended Ceilings
- Stud Walling & Room Layout
- Kitchen / Wall Unit Installation
- General Levelling up to 457m (with detector)
- Tiling
- Interior Trim Carpentry
- Flooring & Decking
- Concrete Forming
- Site Layout
- Excavation
- Landscaping



Specifications	
Type	Rotary
Levelling Type	Self
Laser Class	2
Plumb	Up only
Slope Mode	Single plane
Speeds	0/60/250/600 RPM
Scan Mode	Yes
Accuracy (line/rotary)	3mm @ 30m
Compensation Range	± 8°
Screw Thread for Adapter	5/8"
Working Range	45m
Working Range with Detector	457m (Dia.)
Batteries (Alkaline unless otherwise noted)	18V DEWALT
Battery Life (all lasers on)	1.5Ah = 17 Hours 2Ah = 22 Hours 3Ah = 33 Hours 5Ah = 56 hours
Operating Temperature	-10°C > 50°C
IP Rating	IP54

### Kit Contents

Rotary laser. Tstak case. Detector. Laser target. Glasses. Ceiling bracket.

Code	Description	Barcode
DCE074NR-XJ	DEWALT® DCE074 18V ROTARY LASER – BARE UNIT	5035048658048



# ROTARY LASERS

## DCE079D 1G-XE DEWALT® 18V ROTARY LASER – GREEN BEAM

Green beam rotary laser featuring a TRUE GREEN DIODE. Beam is 4x more visible to the naked eye, making it ideal for use in bright conditions. 2m drop tested and IP67 rated they have been designed for use in the toughest of conditions. Has increased range, power and accuracy over the DCE074 and features dual plane slopes for site layout jobs. Power comes courtesy of the Dewalt 18V battery platform and offers runtime of up to 42 hours (5Ah battery). Comes complete with Tstak storage box, 2.0Ah battery, charger and accessories. DEWALT® XR FLEXVOLT™ Compatible.

**GREEN BEAM**  
**4X VISIBILITY**



**Horizontal 360° beam with vertical spot**

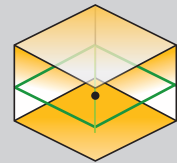

**Vertical rotary 360° beam**

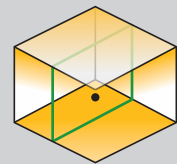

**Dual Plane Slope +/- 10%**

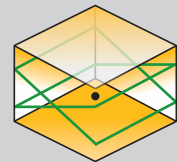

Specifications	
Type	Rotary
Levelling Type	Self
Laser Class	2
Plumb	Up / Down
Slope Mode	Dual plane
Speeds	0/60/250/600 RPM
Scan Mode	Yes
Accuracy (line/rotary)	1.5mm @ 30m
Compensation Range	± 8°
Screw Thread for Adapter	5/8"
Working Range	76m
Working Range with Detector	600m (Dia.)
Batteries (Alkaline unless otherwise noted)	18V DEWALT
Battery Life (all lasers on)	1.5Ah = 14 Hours 2Ah = 19 Hours 3Ah = 29 Hours 5Ah = 48 hours
Operating Temperature	-10°C > 50°C
IP Rating	IP67

### Applications Guide

- Suspended Ceilings
- Stud Walling & Room Layout
- Kitchen / Wall Unit Installation
- General Levelling up to 600m (with detector)
- Tiling
- Interior Trim Carpentry
- Flooring & Decking
- Concrete Forming – Slope Forming
- Site Layout
- Excavation
- Landscaping



### Kit Contents

Rotary laser. Tstak case. Detector & bracket. Laser target. Glasses. 2.0Ah battery. Charger. Remote control. Ceiling bracket.

Code	Description	Barcode
DCE079D 1G-XE	DEWALT® DCE079 18V Rotary Laser – w/ Battery & Charger – Green Beam	5035048657980

# LASER MEASURING

## DW03101-XJ DEWALT® 100M LASER DISTANCE MEASURE

A jobsite tough laser distance measure . Covers the full range of functions including Pythagoras, stake out and memory functions . Accurate to 1.0mm over 100m maximum distance.



Specifications	
Model	100m
Measuring Type	Laser
Laser Class	2
Accuracy	1.0mm/m
Distance	100m
Length	YES
Area	YES
Volume	YES
Continuous Measure	YES
Bluetooth	NO
Stake Out	YES
Pythagoras	YES
Hidden Height	YES
Add / Subtract	YES
Corner piece	YES
Inclinometer	YES
Case	YES
Memory	20 Readings
Backlit	YES
Triangular Area	YES
Partial Height	YES
IP Rating	IP54

### Kit Contents

Laser distance measure. Soft carry case. Batteries.

Code	Description	Barcode
DW03101-XJ	DEWALT® 100M LASER DISTANCE MEASURE	5035048448502

# LASER MEASURING

## DW03050-XJ DEWALT® 50M LASER DISTANCE MEASURE

A jobsite tough laser distance measure . Covers basic functions. Accurate to 1.5mm over 50m maximum distance.



Specifications	
Model	50m
Measuring Type	Laser
Laser Class	2
Accuracy	1.5mm/m
Distance	50m
Length	YES
Area	YES
Volume	YES
Continuous Measure	NO
Bluetooth	NO
Stake Out	NO
Pythagoras	NO
Hidden Height	NO
Add / Subtract	YES
Corner piece	NO
Inclinometer	NO
Case	YES
Memory	5 Readings
Backlit	YES
Triangular Area	NO
Partial Height	NO
IP Rating	IP54

### Kit Contents

Laser distance measure. Soft carry case. Batteries.

Code	Description	Barcode
DW03050-XJ	DEWALT® 50M LASER DISTANCE MEASURE	5035048448496



# LASER MEASURING

## DW033-XJ DEWALT® 30M LASER DISTANCE MEASURE

A simple, rugged 30m distance measure that makes quick estimates of distance as simple as pushing a button. Features digital tape measure function. Units in metric and imperial.



Specifications	
Model	30m
Measuring Type	Laser
Accuracy (line/rotary)	3.0mm/m
Distance	30m
Length	YES
Continuous Measure	YES
Memory	1 Reading
Backlit	YES
IP Rating	IP54

### Kit Contents

Laser distance measure. Batteries.

Code	Description	Barcode
DW033-XJ	DEWALT® 30M LASER DISTANCE MEASURE	5035048657676

## DW030PL-XJ DEWALT® 9M POCKET LASER DISTANCE MEASURE

Probably the smallest laser distance measure in the world. Powered by an internal lithium battery and USB rechargeable. Ideal for quick estimates and measuring. Suitable for all trades.



Specifications	
Model	9m
Measuring Type	Laser
Accuracy (line/rotary)	6.0mm @ 9m
Distance	9m
Length	YES
Memory	1 Reading

### Kit Contents

Laser distance measure. USB charging cable.

Code	Description	Barcode
DW030PL-XJ	DEWALT® 9M POCKET LASER DISTANCE MEASURER	5035048669747

# LASER ACCESSORIES

## DEWALT® TRIPOD – 1/4"

- Light duty tripod for use with lasers with 1/4" threads
- Working height 600 - 1700mm



Code	Description	Barcode
DE0881-XE	DEWALT® TRIPOD – 1/4"	5035048401088

## DEWALT® SITE TRIPOD – 5/8"

- Aluminium construction grade tripod for use with rotaries and larger 5/8" lasers
- Working height 1000mm - 1700mm



Code	Description	Barcode
DE0736-XJ	DEWALT® CONSTRUCTION TRIPOD	5035048101841

## DEWALT® CROSS LINE LASER DETECTORS

- For use with compatible cross line lasers up to 50m
- Includes mounting bracket



Code	Description	Barcode
DE0892-XE	DEWALT® CROSS LINE DETECTOR - RED	5035048390078
DE0892G-XJ	DEWALT® CROSS LINE DETECTOR - GREEN	5035048642351

## DEWALT® LASER TARGETS

- Enhances visibility and aids in targeting



Code	Description	Barcode
DE0730-XJ	DEWALT® RED TARGET	5035048101797
DE0730G-XJ	DEWALT® GREEN TARGET	5035048642368

## DEWALT® GRADING ROD

- 1.2 - 4.0m



Code	Description	Barcode
DE0734-XJ	DEWALT® GRADING ROD	5035048101858

## DEWALT® LASER GLASSES

- Enhances visibility



Code	Description	Barcode
DW0714	DEWALT® LASER GLASSES - RED	028877368290
DE0714G-XE	DEWALT® LASER GLASSES - GREEN	5035048642382

**GUARANTEED TOUGH.®**

DEWALT® DEALER:

DEWALT® AU  
810 Whitehorse Road, Box Hill, Victoria, 3128  
Telephone: 1800 338 002 | Fax: 1800 080 898

**www.DEWALT.com**

The yellow and black colour scheme is used on DeWALT® Power Tools and Accessories as a trademark. DeWALT® reserves the right to revise product offerings & specifications at any time without notice.

**MY DEWALT®**