

374 FC/375 FC/376 FC/ 902 FC

Clamp Meter

Calibration Manual

LIMITED WARRANTY AND LIMITATION OF LIABILITY

Each Fluke product is warranted to be free from defects in material and workmanship under normal use and service. The warranty period is three years and begins on the date of shipment. Parts, product repairs, and services are warranted for 90 days. This warranty extends only to the original buyer or end-user customer of a Fluke authorized reseller, and does not apply to fuses, disposable batteries, or to any product which, in Fluke's opinion, has been misused, altered, neglected, contaminated, or damaged by accident or abnormal conditions of operation or handling. Fluke warrants that software will operate substantially in accordance with its functional specifications for 90 days and that it has been properly recorded on non-defective media. Fluke does not warrant that software will be error free or operate without interruption.

Fluke authorized resellers shall extend this warranty on new and unused products to end-user customers only but have no authority to extend a greater or different warranty on behalf of Fluke. Warranty support is available only if product is purchased through a Fluke authorized sales outlet or Buyer has paid the applicable international price. Fluke reserves the right to invoice Buyer for importation costs of repair/replacement parts when product purchased in one country is submitted for repair in another country. Fluke's warranty obligation is limited, at Fluke's option, to refund of the purchase price, free of charge repair, or replacement of a defective product which is returned to a Fluke authorized service center within the warranty period.

To obtain warranty service, contact your nearest Fluke authorized service center to obtain return authorization information, then send the product to that service center, with a description of the difficulty postage and insurance prepaid (FOB Destination). Fluke assumes no risk for damage in transit. Following warranty repair, the product will be returned to Buyer, transportation prepaid (FOB Destination). If Fluke determines that failure was caused by neglect, misuse, contamination, alteration, accident, or abnormal condition of operation or handling, including overvoltage failures caused by use outside the product's specified rating, or normal wear and tear of mechanical components, Fluke will provide an estimate of repair costs and obtain authorization before commencing the work. Following repair, the product will be returned to the Buyer transportation prepaid and the Buyer will be billed for the repair and return transportation charges (FOB Shipping Point).

THIS WARRANTY IS BUYER'S SOLE AND EXCLUSIVE REMEDY AND IS IN LIEU OF ALL OTHER WARRANTIES, EXPRESS OR IMPLIED, INCLUDING BUT NOT LIMITED TO ANY IMPLIED WARRANTY OF MERCHANTABILITY OR FITNESS FOR A PARTICULAR PURPOSE. FLUKE SHALL NOT BE LIABLE FOR ANY SPECIAL, INDIRECT, INCIDENTAL OR CONSEQUENTIAL DAMAGES OR LOSSES, INCLUDING LOSS OF DATA, ARISING FROM ANY CAUSE OR THEORY.

Since some countries or states do not allow limitation of the term of an implied warranty, or exclusion or limitation of incidental or consequential damages, the limitations and exclusions of this warranty may not apply to every buyer. If any provision of this Warranty is held invalid or unenforceable by a court or other decision-maker of competent jurisdiction, such holding will not affect the validity or enforceability of any other provision..

Fluke Corporation	Fluke Europe B.V.
P.O. Box 9090	P.O. Box 1186
Everett, WA 98206-9090	5602 BD Eindhoven
U.S.A.	The Netherlands

Contents

Title	Page
Introduction	1
How to Contact Fluke	1
Safety Information	2
The Product	4
374 FC/375 FC/376 FC Electrical Specifications	4
AC Current via Jaw	4
AC Current via Flexible Current Probe	4
Position Sensitivity	5
DC Current	5
AC Voltage	5
DC Voltage	5
mV dc (375 FC and 376 FC)	5
Frequency via Jaw	6
Frequency via Flexible Current Probe	6
Resistance	6
Capacitance	6
902 FC Electrical Specifications	6
Mechanical Specifications	7
Environmental Specifications	7
Performance Tests	8
Calibration Adjustment	9
Calibration Setup	11
VAC Adjustment Procedure	12
VDC/mVDC Adjustment Procedure	13
Ohm/Cap Adjustment Procedure	13
AAC Adjustment Procedure (374 FC, 375 FC, 376 FC)	14
AAC Adjustment Procedure (902 FC)	14
ADC Adjustment Procedure (374 FC, 375 FC, 376 FC)	14
uADC Adjustment Procedure (902 FC)	14
ROGO Adjustment Procedure (374 FC, 375 FC, 376 FC)	15
Temperature Adjustment Procedure (902 FC)	15
902 FC Temperature Zero Procedure	15
Maintenance	15
Clean the Product	15
Battery Replacement	15
Replacement Parts	16

Introduction

⚠⚠ Warning

To prevent electric shock or personal injury, read the *Safety Information* before you use the Product.

This manual provides all the information necessary to perform basic maintenance and make calibration adjustments for the 374 FC/375 FC/376 FC and the 902 FC Clamp Meters (the Product). All figures show the 376 FC unless noted.

For complete operating instructions, refer to the *375 FC/375 FC/376 FC Users Manual* and the *902 FC Users Manual* at www.fluke.com.

How to Contact Fluke

To contact Fluke, use one of these telephone numbers:

- Technical Support USA: 1-800-44-FLUKE (1-800-443-5853)
- Calibration/Repair USA: 1-888-99-FLUKE (1-888-993-5853)
- Canada: 1-800-36-FLUKE (1-800-363-5853)
- Europe: +31 402-675-200
- Japan: +81-3-6714-3114
- Singapore: +65-6799-5566
- China: +86-400-810-3435
- Anywhere in the world: +1-425-446-5500

Or, visit Fluke's website at www.fluke.com.

To register your product, visit <http://register.fluke.com>.

To view, print, or download the latest manual supplement, visit <http://us.fluke.com/usen/support/manuals>.

Safety Information

A **Warning** identifies hazardous conditions and procedures that are dangerous to the user. A **Caution** identifies conditions and procedures that can cause damage to the Product or the equipment under test.

Warning

To prevent possible electrical shock, fire, or personal injury:

- Carefully read all instructions.
- Read all safety information before you use the Product.
- Use the Product only as specified, or the protection supplied by the Product can be compromised.
- Do not use the Product around explosive gas, vapor, or in damp or wet environments.
- Do not use the Product if it operates incorrectly.
- Do not use the Product if it is altered or damaged.
- Disable the product if it is damaged.
- Use only correct measurement category (CAT), voltage, and amperage rated probes, test leads, and adapters for the measurement.
- Do not exceed the Measurement Category (CAT) rating of the lowest rated individual component of a Product, probe, or accessory.
- Comply with local and national safety codes. Use personal protective equipment (approved rubber gloves, face protection, and flame-resistant clothes) to prevent shock and arc blast injury where hazardous live conductors are exposed.
- Before each use, examine the Product. Look for cracks or missing pieces of the clamp housing or output cable insulation. Also look for loose or weakened components. Carefully examine the insulation around the jaws.
- Do not use test leads if they are damaged. Examine the test leads for damaged insulation and measure a known voltage.
- Do not touch voltages >30 V ac rms, 42 V ac peak, or 60 V dc.
- Do not measure current while the test leads are in the input jacks.
- Do not apply more than the rated voltage, between the terminals or between each terminal and earth ground.
- De-energize the circuit or wear personal protective equipment in compliance with local requirements before you apply or remove the Flexible Current Probe.
- Measure a known voltage first to make sure that the Product operates correctly.
- Limit operation to the specified measurement category, voltage, or amperage ratings.
- The battery door must be closed and locked before you operate the Product.
- Connect the common test lead before the live test lead and remove the live test lead before the common test lead.
- Remove all probes, test leads, and accessories before the battery door is opened.
- Keep fingers behind the finger guards on the probes.
- Hold the Product behind the tactile barrier.
- Replace the batteries when the low battery indicator shows to prevent incorrect measurements.
- Do not use the HOLD function to measure unknown potentials. When HOLD is turned on, the display does not change when a different potential is measured.

- **Disconnect power and discharge all high-voltage capacitors before you measure resistance, continuity, capacitance, or a diode junction.**
- **Remove the input signals before you clean the Product.**
- **Use only specified replacement parts.**
- **When batteries are changed, ensure that the calibration seal in the battery compartment is not damaged. If damaged, the Product may not be safe to use.**
- **Return the Product to Fluke for replacement of the seal.**
- **Do not use in CAT III or CAT IV environments without the protective cap of test probe, The protective cap decreases the expose probe metal < 4mm. This decreases the possibility of arc flash from short circuits.**
- **Do not place magnet inside Category IV panel. Place it outside the panel instead.**

For safe operation and maintenance of the Product:

- **Repair the Product before use if the battery leaks.**
- **Have an approved technician repair the Product.**

⚠ Caution

To prevent possible damage to the Product or to equipment under test:

- **Use the correct terminals, function, and range for measurements.**
- **Clean the case and accessories with a damp cloth and mild detergent only. Do not use abrasives or solvents.**

Note

The Measurement Category (CAT) and voltage rating of any combination of test probe, test probe accessory, current clamp accessory, and the Product is the LOWEST rating of any individual component.

Symbols used on the Product and in this manual are explained in Table 1.

Table 1. Symbols















Symbol	Description
	Consult user documentation.
	WARNING. RISK OF DANGER.
	WARNING. HAZARDOUS VOLTAGE. Risk of electric shock.
	Do not apply around or remove from uninsulated hazardous live conductors without taking additional protective measures.
	Application around and removal from uninsulated hazardous live conductors is permitted.
	Earth
	Double Insulated
	AC (Alternating Current)
	DC (Direct Current)
	Both direct and alternating current
	Certified by TÜV SÜD Product Service.
	Conforms to relevant Australian EMC standards.
	Certified by CSA Group to North American safety standards.
	Conforms to European Union directives.
CAT II	Measurement Category II is applicable to test and measuring circuits connected directly to utilization points (socket outlets and similar points) of the low-voltage MAINS installation.
CAT III	Measurement Category III is applicable to test and measuring circuits connected to the distribution part of the building's low-voltage MAINS installation.

Table 1. Symbols (cont.)

Symbol	Description
CAT IV	Measurement Category IV is applicable to test and measuring circuits connected at the source of the building's low-voltage MAINS installation.
	This product complies with the WEEE Directive marking requirements. The affixed label indicates that you must not discard this electrical/electronic product in domestic household waste. Product Category: With reference to the equipment types in the WEEE Directive Annex I, this product is classed as category 9 "Monitoring and Control Instrumentation" product. Do not dispose of this product as unsorted municipal waste.

The Product

⚠ ⚠ Warning

To prevent possible electrical shock, fire, or personal injury:

- When measuring current with the Jaw, keep fingers behind the Tactile Barrier ①.

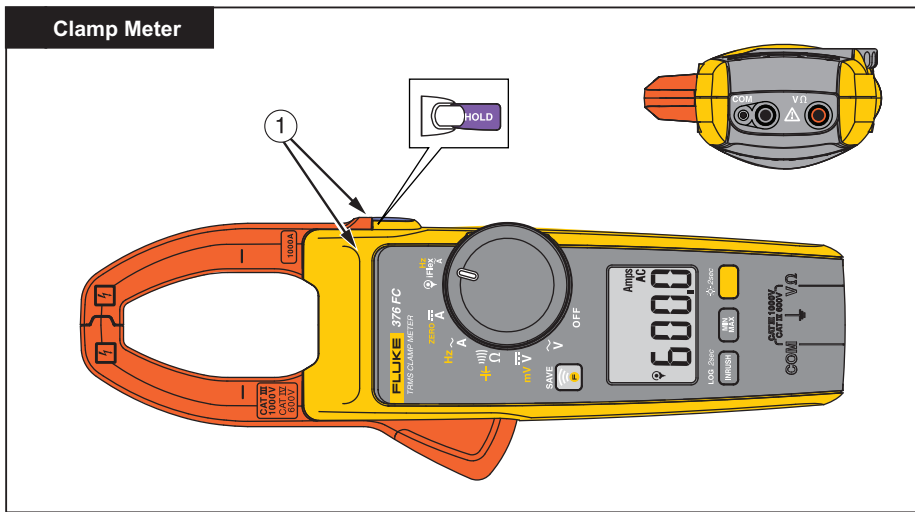

Figure 1. The Product

fig01.eps

374 FC/375 FC/376 FC Electrical Specifications

AC Current via Jaw

Range

374 FC and 375 FC.....	600.0 A
376 FC	999.9 A
Resolution	0.1 A
Accuracy	2 % ±5 digits (10 Hz to 100 Hz)
	2.5 % ±5 digits (100 to 500 Hz)

Crest Factor (50 Hz/60 Hz)

376 FC	3 @ 500 A
	2.5 @ 600 A
	1.42 @ 1000 A
374 FC and 375 FC.....	2.5 @ 350 A
	1.42 @ 600 A

Note: Add 2 % for C.F. > 2

AC Current via Flexible Current Probe

Range.....	2500 A
Resolution	0.1 A (≤999.9 A)
	1 A (≤ 2500 A)
Accuracy	3 % ±5 digits (5 Hz to 500 Hz)

Crest Factor (50 Hz/60 Hz) 3.0 at 1100 A (375 FC and 376 FC only)
 2.5 at 1400 A
 1.42 at 2500 A
 Add 2 % for C.F. >2

Position Sensitivity

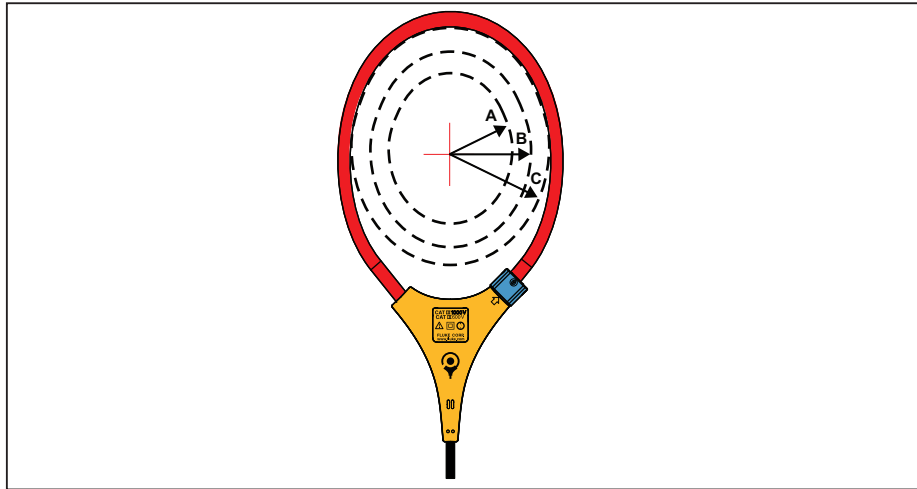

Figure 2. Position Sensitivity

ghn12.eps

Distance from Optimum	i2500-10 Flex	i2500-18 Flex	Error
A	0.5 in (12.7 mm)	1.4 in (35.6 mm)	±0.5 %
B	0.8 in (20.3 mm)	2.0 in (50.8 mm)	±1.0 %
C	1.4 in (35.6 mm)	2.5 in (63.5 mm)	±2.0 %
Measurement uncertainty assumes centralized primary conductor at optimum position, no external electrical or magnetic field, and within operating temperature range.			

DC Current

Range
 374 FC and 375 FC 600.0 A
 376 FC 999.9 A
 Resolution 0.1 A
 Accuracy 2 % ±5 digits

AC Voltage

Range 1000 V
 Resolution 0.1 V (≤600.0 V)
 1 V (≤1000 V)
 Accuracy 1.5 % ±5 digits (20 Hz to 500 Hz)

DC Voltage

Range 1000 V
 Resolution 0.1 V (≤600.0 V)
 1 V (≤1000 V)
 Accuracy 1 % ±5 digits

mV dc (375 FC and 376 FC)

Range 500.0 mV
 Resolution 0.1 mV
 Accuracy 1 % ±5 digits

Mechanical Specifications

Size (L x W x H)	
374 FC/375 FC/376 FC.....	249 mm x 85 mm x 45 mm
902FC	230 mm x 83.7 mm x 45.4 mm
Weight	
374 FC/375 FC/376 FC.....	410 g
902 FC	382 g

Environmental Specifications

Operating Temperature.....	-10 °C to +50 °C
Storage Temp	
374 FC/375 FC/376 FC.....	-40 °C to +60 °C
902 FC	-30 °C to +60 °C
Operating Humidity	Non condensing (<10 °C)
	≤90 % RH (at 10 °C to 30 °C)
	≤75 % RH (at 30 °C to 40 °C)
	≤45 % RH (at 40 °C to 50 °C)
Operating Altitude	2000 meters
Storage Altitude	12 000 meters
Safety	
374 FC/375 FC/376 FC.....	IEC 61010-1, Pollution Degree 2
	IEC 61010-2-032: CAT III 1000V / CAT IV 600V
	IEC 61010-2-033: CAT III 1000V / CAT IV 600V
902 FC	IEC 61010-1, Pollution Degree 2
	IEC 61010-2-032: CAT III 600 V / CAT IV 300 V
	IEC 61010-2-033: CAT III 600 V / CAT IV 300 V
Intrusion Protection (IP) Rating	IEC 60529: IP30
Radio Frequency Certification.....	FCC ID:T68-FBLE IC:6627A-FBLE
Wireless Radio Frequency Range	2412 MHz to 2462 MHz
Output Power	<100 mW
Electromagnetic Compatibility (EMC)	
International	IEC 61326-1: Portable, Electromagnetic Environment, IEC 61326-2-2, CISPR 11: Group 1, Class A
<i>Group 1: Equipment has intentionally generated and/or uses conductively-coupled radio frequency energy that is necessary for the internal function of the equipment itself.</i>	
<i>Class A: Equipment is suitable for use in all establishments other than domestic and those directly connected to a low-voltage power supply network that supplies buildings used for domestic purposes. There may be potential difficulties in ensuring electromagnetic compatibility in other environments due to conducted and radiated disturbances.</i>	
<i>Caution: This equipment is not intended for use in residential environments and may not provide adequate protection to radio reception in such environments.</i>	
<i>Emissions that exceed the levels required by CISPR 11 can occur when the equipment is connected to a test object.</i>	
<i>The equipment may not meet the immunity requirements of this standard when test leads and/or test probes are connected.</i>	
Temperature Coefficients.....	Add 0.1 x specified accuracy for each °C above 28 °C or below 18 °C

Performance Tests

Performance tests make sure that the Product operates within the published specifications. Do the performance tests periodically and after service or repair. If the Product fails any part of the verification test, repair, and/or calibration adjustments are required. See *Calibration Adjustment*.

In this section the Product is called the UUT (unit under test). Use these verification performance tests to make sure the values indicated on the UUT correspond, as closely as possible, with the actual measurement values.

For each test:





1. Set the UUT to the appropriate function.
2. Connect the UUT to the Calibrator.
3. Set the Calibrator output.
4. Compare the results to Table 2. (Where X = not applicable.)

The test passes if the UUT reads between the upper and lower limit.

Table 2. Performance Tests

Function	Calibrator Output	374 FC	375FC	376 FC	902 FC	Meter Reading Limit	
						Lower Limit	Upper limit
\tilde{V} VAC	20 V, 20 Hz	√	√	√	X	19.2	20.8
	10 V, 50 Hz	√	√	√	√	9.4	10.7
	500 V, 50 Hz	√	√	√	√	492.0	508.0
	1000 V, 50 Hz	√	√	√	X	980	1020
	10 V, 400 Hz	√	√	√	√	9.4	10.7
	500 V, 400 Hz	√	√	√	√	492.0	508.0
\bar{V} VDC	-1000	√	√	√	X	-1015	-985
	-10	√	√	√	√	-10.6	-9.4
	10	√	√	√	√	9.4	10.6
	500	√	√	√	√	494.5	505.5
	1000	√	√	√	X	985	1015
mV \bar{V} mVDC	50 mV	X	√	√	X	49.0 mV	51.0 mV
	500 mV	X	√	√	X	494.5 mV	505.5 mV
	-500 mV	X	√	√	X	-505.5 mV	-494.5 mV
Ω Ohms	0 Ω	√	√	√	√	-0.5 Ω	0.5 Ω
	10 Ω	√	√	√	√	9.4 Ω	10.6 Ω
	300 Ω	√	√	√	√	296.5 Ω	303.5 Ω
	3000 Ω	√	√	√	√	2965 Ω	3035 Ω
	30 k Ω	X	√	√	√	29.65 k Ω	30.35 k Ω
$\mu\Omega$ Capacitance	5 μF	√	√	√	√	4.6 μF	5.5 μF
	90 μF	√	√	√	√	88.7 μF	91.3 μF
	500 μF	√	√	√	√	491 mF	509 μF
\tilde{A} AAC with 50 turns coil	2 A, 50 Hz	√	√	√	√	97.5	102.5
	12 A, 50 Hz	√	√	√	√	587.5	612.5
	19.5 A, 50 Hz	X	X	√	X	955	995

Table 2. Performance Tests (cont.)

Function	Calibrator Output	374 FC	375 FC	376 FC	902 FC	Meter Reading Limit	
						Lower Limit	Upper limit
 ADC with 50 turns coil	-19.5 A	X	X	√	X	-995 A	-955 A
	-12 A	√	√	√	X	-612.5 A	-587.5 A
	-0.2 A	√	√	√	X	-10.7 A	-9.3 A
	0.2 A	√	√	√	X	9.3 A	10.7 A
	2 A	√	√	√	X	97.5 A	102.5 A
	12 A	√	√	√	X	587.5 A	612.5 A
	19.5 A	X	X	√	X	955.0 A	995.0 A
 Hz iFLEX iFlex Current Probe (with simulation)	3 mV, 50 Hz	√	√	√	X	96.5 A	103.5 A
	27 mV, 50 Hz	√	√	√	X	872.5 A	927.5 A
	60 mV, 50 Hz	√	√	√	X	1935 A	2065 A
	75 mV, 50 Hz	√	√	√	X	2420 A	2580 A
	750 mV, 500 Hz	√	√	√	X	2420 A	2580 A
 Hz iFLEX iFlex Current Probe (with 50 turns r-coil)	0.2 A, 50 Hz	√	√	√	X	9.2 A	10.8 A
	10 A, 50 Hz	√	√	√	X	484.5 A	515.5 A
	18 A, 50 Hz	√	√	√	X	872.5 A	927.5 A
	6 A, 440 Hz	√	√	√	X	290.5 A	309.5 A
 μADC	0 μA	X	X	X	√	-0.5 μA	0.5 μA
	10 μA	X	X	X	√	9.4 μA	10.6 μA
	200 μA	X	X	X	√	197.5 μA	202.5 μA
	-200 μA	X	X	X	√	-202.5 μA	-197.5 μA
 Temperature	-40 °C	X	X	X	√	-41.2 °C	-38.8 °C
	0 °C	X	X	X	√	-0.8 °C	0.8 °C
	50 °C	X	X	X	√	48.7 °C	51.3 °C
	400 °C	X	X	X	√	395.2 °C	404.8 °C

Calibration Adjustment

Use the calibration procedures to adjust the Product so that the values shown on the Product correspond as closely as possible with the actual measured values. Table 3 is a list of the equipment required for the calibration adjustment.

Table 3. Required Equipment

Equipment	Required Characteristics	Recommended Model
Calibrator	4.5-digit resolution	Fluke 55xxA Calibrator
Wired coil	50 turns	5500A/COIL
Test Lead for iFlex	--	PN 666602
Test Lead for other	--	PN 2070140
Power Supply	+3.0 V	Common power supply or a 2 x AA or AAA battery container



Static Awareness



Semiconductors and integrated circuits can be damaged by electrostatic discharge during handling. This notice explains how to minimize damage to these components.

1. Understand the problem.
2. Learn the guidelines for proper handling.
3. Use the proper procedures, packaging, and bench techniques.

Follow these practices to minimize damage to static sensitive parts.

Warning

**To prevent electric shock or personal injury.
De-energize the product and all active circuits
before opening a product enclosure, touching or
handling any PCBs or components.**



- Minimize handling.
- Handle static-sensitive parts by non-conductive edges.
- Do not slide static-sensitive components over any surface.
- When removing plug-in assemblies, handle only by non-conductive edges.
- Never touch open-edge connectors except at a static-free work station.

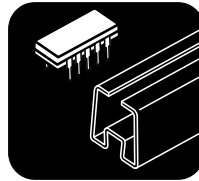

- Keep parts in the original containers until ready for use.
- Use static shielding containers for handling and transport.
- Avoid plastic, vinyl, and Styrofoam® in the work area.

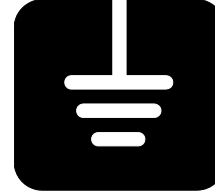

- Handle static-sensitive parts only at a static-free work station.
- Put shorting strips on the edge of the connector to help protect installed static-sensitive parts.
- Use anti-static type solder extraction tools only.
- Use grounded-tip soldering irons only.

Calibration Setup

To set up the Product for calibration:

1. Turn the Product over and use a flat-head screwdriver to remove the battery compartment screw. See Figure 3.
2. Remove the battery door.
3. Remove the batteries.

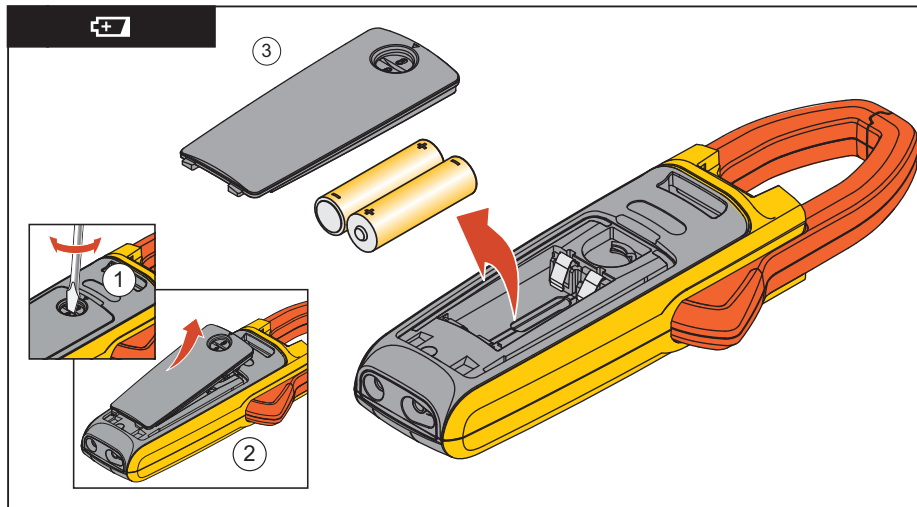

Figure 3. Remove Batteries

fig02.eps

4. Remove the calibration sticker.
5. Connect the Power Supply to the Product battery terminals.
6. Turn on the Product.
7. Use a small jumper to short the two pads together under the calibration sticker. See Figure 4.

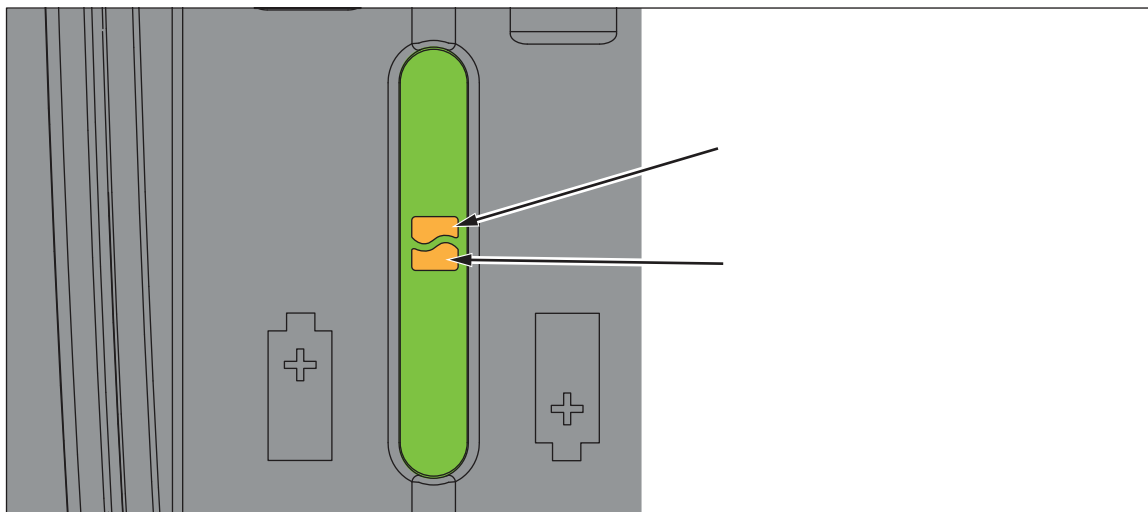
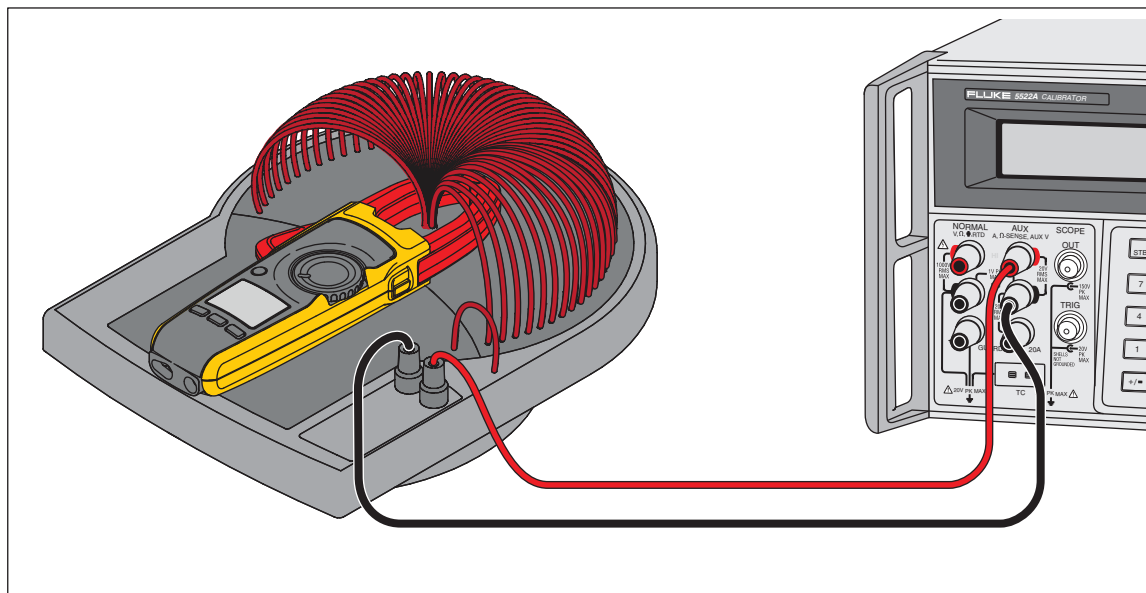

Figure 4. Calibration Activation

ghn51.eps



8. To setup the current calibration see Figure 5.





ghn50.eps

Figure 5. Current Calibration Setup

9. For each calibration adjustment:
 - a. Turn the rotary knob to select the function.
 - b. Apply the required output from the source to the Product.
 - c. Wait until each applied output stabilizes.

On the 37x FC Products, push  to confirm the value and move to the next step in the Adjustment Procedure. When you have completed all the steps, push  to save the data to NVRAM storage.

On the 902 FC Products, push  to confirm the value and move to the next step in the Adjustment Procedure. When you have completed all the steps, push  to save the data to NVRAM storage.

10. To view the target calibration point, push .
11. When calibration is complete:
 - a. Remove the power supply.
 - b. Replace the batteries.
 - c. Replace the battery compartment door and tighten the battery compartment screw.

VAC Adjustment Procedure

Step	LCD Display	374 FC	375 FC	376 FC	902 FC	Calibrator Output
1	C-00	√	√	√	√	0 V, 0 Hz
2	C-01	√	√	√	√	600 V, 50 Hz
3	C-02	√	√	√	√	300 V, 50 Hz
4	C-03	√	√	√	√	300 V, 100 Hz
5	C-04	√	√	√	√	300 V, 200 Hz
6	C-05	√	√	√	√	300 V, 300 Hz
7	C-06	√	√	√	√	300 V, 400 Hz
8	C-07	√	√	√	√	300 V, 500 Hz
9	Save	√	√	√	√	STBY

VDC/mVDC Adjustment Procedure

Step	LCD Display	374 FC	375 FC	376 FC	902 FC	Calibrator Output
1	C-08	√	√	√	√	0 V
2	C-09	√	√	√	√	600 V
3	C-10	√	√	√	√	0 V
4	C-11	√	√	√	√	0.5 V
5	Save	√	√	√	√	STBY

Ohm/Cap Adjustment Procedure

Step	LCD Display	374 FC	375 FC	376 FC	902 FC	Calibrator Output
1	C-12	√	√	√	√	0 Ω
2	C-13	√	√	√	√	600 Ω
3	C-14	√	√	√	√	660 Ω
4	C-15	√	√	√	√	6000 Ω
5	C-16	√	√	√	√	6600 Ω
6	C-17	√	√	√	√	60 000 Ω
7	C-18	√	√	√	√	0.1 μF
8	C-19	√	√	√	√	0.5 μF
9	C-20	√	√	√	√	1.5 μF
10	C-21	√	√	√	√	110 μF
11	C-22	√	√	√	√	500 μF
12	C-23	√	√	√	√	1000 μF
13	Save	√	√	√	√	STBY

AAC Adjustment Procedure (374 FC, 375 FC, 376 FC)

Step	LCD Display	374 FC	375 FC	376 FC	Calibrator Output
1	C-24	√	√	√	0 A, 0 Hz
2	C-25	√	√	√	8 A, 50 Hz
3	C-26	√	√	√	3 A, 50 Hz
4	C-27	√	√	√	3 A, 100 Hz
5	C-28	√	√	√	3 A, 200 Hz
6	C-29	√	√	√	3 A, 300 Hz
7	C-30	√	√	√	3 A, 400 Hz
8	C-31	√	√	√	3 A, 440 Hz
9	Save	√	√	√	STBY

AAC Adjustment Procedure (902 FC)

Step	LCD Display	Calibrator Output
1	C-24	0 A, 0 Hz
2	C-25	3 A, 50 Hz
3	C-26	8 A, 50 Hz
4	C-27	3 A, 50 Hz
5	C-28	3 A, 100 Hz
6	C-29	3 A, 200 Hz
7	C-30	3 A, 300 Hz
8	C-31	3 A, 400 Hz
9	C-32	3 A, 440 Hz
10	Save	STBY

ADC Adjustment Procedure (374 FC, 375 FC, 376 FC)

Step	LCD Display	374 FC	375 FC	376 FC	Calibrator Output
1	C-32	√	√	√	0 A
2	C-33	√	√	√	10 A
3	Save	√	√	√	STBY

uADC Adjustment Procedure (902 FC)

Step	LCD Display	902 FC	Calibrator Output
1	C-32	√	0 A
2	C-33	√	200 μA
3	Save	√	STBY

ROGO Adjustment Procedure (374 FC, 375 FC, 376 FC)



Step	LCD Display	374 FC	375 FC	376 FC	Calibrator Output
1	C-34	√	√	√	0 V, 0 Hz
2	C-35	√	√	√	60 mV, 50 Hz
3	C-36	√	√	√	30 mV, 50 Hz
4	C-37	√	√	√	60 mV, 100 Hz
5	C-38	√	√	√	120 mV, 200 Hz
6	C-39	√	√	√	180 mV, 300 Hz
7	C-40	√	√	√	240 mV, 400 Hz
8	C-41	√	√	√	300 mV, 500 Hz
9	Save	√	√	√	STBY

Temperature Adjustment Procedure (902 FC)

Step	LCD Display	902 FC	Calibrator Output
1	C-35	√	0 V, 0 Hz
2	C-36	√	0.02 V, 0 Hz
3	Save	√	STBY

902 FC Temperature Zero Procedure

After you do the temperature adjustment (See *Temperature Adjustment Procedure (902 FC)*), you must zero the temperature.

1. Insert the K-type thermocouple connector to attach the 5522A and the Product.
2. Turn off the Product and wait 20 minutes.
3. Turn on the Product.
4. Use a small probe to push the calibration button.
5. Turn the control knob to .
6. Push  twice, until the LCD shows C-37.

Step	LCD Display	902 FC	Calibrator Output
1	C-37	√	0 °C
2	Save	√	STBY

Maintenance

This section contains basic maintenance procedures.

Clean the Product

⚠ Caution

To prevent possible damage to the Product or to equipment under test, do not use abrasive cleaners. They will damage the case.

To clean the Product, use a cloth with a mild cleaning solution.

Battery Replacement

⚠⚠ Warning

To prevent possible electrical shock, fire, or personal injury, and to prevent incorrect measurements, replace the batteries when the low battery indicator shows.

Replacement Parts

Replacement parts and accessories are listed in Tables 4. To order parts and accessories, see *How to Contact Fluke*.

Table 4. Replacement Parts and Accessories

Fluke Part Number	Description	Quantity
4696918	Battery Door Assembly	1
3752958	Soft Case (374 FC/375 FC/376 FC)	1
1997276	Soft Case(902 FC)	1
4705494	User Manual (374 FC/375 FC/376 FC)	1
4748982	User Manual (902 FC)	1
376756	Battery (AA 1.5 V)	2
855742	TL75 test leads	1
3798105	Fluke i2500-18 Rogowski coil	1
1997234	Thermocouple Assembly, K-Type,Beaded, Molded Dual Banana Plug (80BK)	1
4744076	FLUKE-374 FC,DECAL CELL	1
4744083	FLUKE-375 FC,DECAL CELL	1
4698317	FLUKE-376 FC,DECAL CELL	1