

Manual Supplement

Manual Title: 80 Series V Users
Part Number: Web-Only
Print Date: May 2004
Revision/Date: 2, 11/08

Supplement Issue: **8**
Issue Date: 7/18
Page Count: 7

This supplement contains information necessary to ensure the accuracy of the above manual.

Change #1

On page 42, Table 9, replace the AC72 with:

AC172	Alligator Clips for use with TL175 test lead set.
-------	---------------------------------------------------

Change #2, 55804, 62912, 64090, 509, 167

On page 2, under the **Safety Information**, delete the bullets and move the last sentence on page 5, prior to Table 1:

















Electrical symbols used on the Meter and in the manual are explained in Table 1.

On page 4, add the following to the **Cautions**:

- For best mechanical performance, the Product must remain in the holster at all times.

On page 5, replace Table 1 with:

Table 1. Electrical Symbols

	AC (Alternating Current)		Earth ground
	DC (Direct Current)		Fuse
	Hazardous voltage. Risk of electric shock.		Conforms to European Union directives.
	Risk of Danger. Important information. See Manual.		Conforms to relevant North American Association directives.
	Battery. Low battery when displayed.		Double insulated
	Continuity test or continuity beeper tone.		Capacitance
	Conforms to relevant South Korean EMC Standards.		Inspected and licensed by TÜV Product Services.
	Consult user documentation.		Conforms to relevant Australian EMC standards.
CAT II	Measurement Category II is applicable to test and measuring circuits connected directly to utilization points (socket outlets and similar points) of the low-voltage MAINS installation.		
CAT III	Measurement Category III is applicable to test and measuring circuits connected to the distribution part of the building's low-voltage MAINS installation.		
CAT IV	Measurement Category IV is applicable to test and measuring circuits connected at the source of the building's low-voltage MAINS installation.		

On page 40, replace Table 8 with:

Table 8. Replacement Parts (cont.)

Item	Description	Qty.	Fluke Part or Model Number
AC172	Alligator Clip, Black	1	3970052
AC172	Alligator Clip, Red	1	3970041
TL175	Test Lead Set	1	3967971
MP81	Thermocouple Assembly, K-Type, Beaded, Molded Dual Banana Plug, Coiled	1	1273113
MP390-391	Access Door Fastener	2	948609
NA	Tiltstand	1	2074040
U5	LCD, 4.5 DIGIT, TN, Transflective, Bar Graph, OSPR80	1	2065213
CR6	Lightpipe	1	2074057
S2	Keypad	1	2105884
TM1	80 Series V Multi-Language Safety Information	1	4271753
TM2	80 Series V Quick Reference Card	1	2101986

On page 41, replace Figure 12 with:

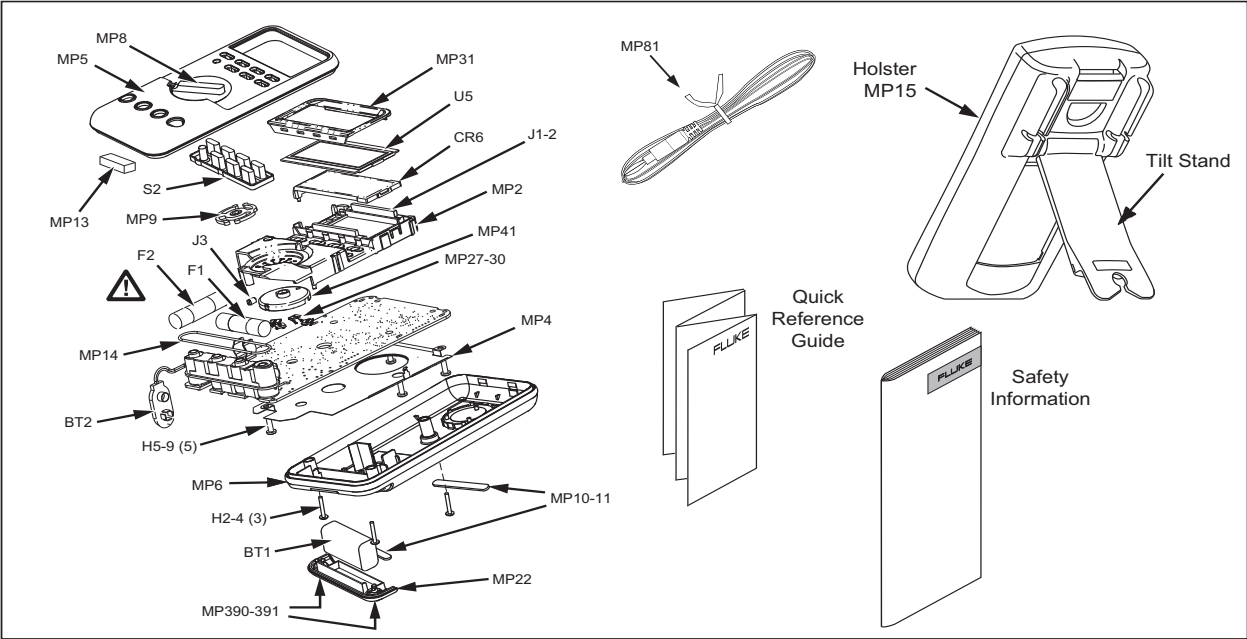

aom015c.eps

Figure 12. Replacement Parts

On page 43, replace the **General Specifications**, with:

General Specifications

Maximum Voltage between any Terminal and Earth Ground: 1000 V rms

Fuse Protection for mA or μ A inputs: 0.44 A, 1000 V, IR 10 kA

Fuse Protection for A input: 11 A, 1000 V, IR 17 kA

Display: Digital: 6000 counts updates 4/sec; (Model 87 also has 19,999 counts in high-resolution mode).

Analog Bargraph: 33 segments, updates 40/sec. Frequency: 19,999 counts, updates 3/sec at > 10 Hz

Temperature: Operating: -20 °C to +50 °C; Storage: -40 °C to +60 °C

Altitude: Operating: 2000 m; Storage: 10,000 m

Temperature Coefficient: 0.05 x (specified accuracy)/ °C (< 18 °C or > 28 °C)

Safety IEC 61010-1: Pollution Degree 2
IEC 61010-2-033: CAT IV 600 V / CAT III 1000 V

Electromagnetic Compatibility (EMC)

International IEC 61326-1: Portable Electromagnetic Environment; IEC 61326-2-2
CISPR 11: Group 1, Class A

Group 1: Equipment has intentionally generated and/or uses conductively-coupled radio frequency energy that is necessary for the internal function of the equipment itself.

Class A: Equipment is suitable for use in all establishments other than domestic and those directly connected to a low-voltage power supply network that supplies buildings used for domestic purposes. There may be potential difficulties in ensuring electromagnetic compatibility in other environments due to conducted and radiated disturbances.

Caution: This equipment is not intended for use in residential environments and may not provide adequate protection to radio reception in such environments.

Emissions that exceed the levels required by CISPR 11 can occur when the equipment is connected to a test object.

Korea (KCC).....Class A Equipment (Industrial Broadcasting & Communication Equipment)

Class A: Equipment meets requirements for industrial electromagnetic wave equipment and the seller or user should take notice of it. This equipment is intended for use in business environments and not to be used in homes.

USA (FCC).....47 CFR 15 subpart B. This product is considered an exempt device per clause 15.103.

Relative Humidity: 0 % to 90 % (0 °C to 35 °C); 0 % to 70 % (35 °C to 55 °C)

Battery Type: 9 V, NEDA 1604 or IEC 6F22

Battery Life: 400 hrs typical with alkaline (with backlight off)

Size (HxWxL): 1.25 in x 3.41 in x 7.35 in (3.1 cm x 8.6 cm x 18.6 cm)

Size with Holster and Flex-Stand: 2.06 in x 3.86 in x 7.93 in (5.2 cm x 9.8 cm x 20.1 cm)

Weight: 12.5 oz (355 g)

Weight with Holster and Flex-Stand: 22.0 oz (624 g)

On page 44, under ***Detailed Specifications***, prior to Table 10 add:

All ranges unless otherwise noted: In an RF field of 3 V/m total accuracy = specified accuracy + 20 counts, except 600 µA dc range total accuracy = specified accuracy + 60 counts. Temperature not specified.

Some mobile devices that transmit RF energy may transmit levels that far exceed 3 V/m and may damage sensitive electronic circuits. To insure the best performance, do not allow a device that is transmitting RF energy in excess of 3 V/m to be within 30 cm of the meter while in use.

Change #3, 573

On page 48, Table 14, replace note 4 with:

4. Δ >10 A accuracy is unspecified. Duty cycle: 10 A continuous up to 35 °C, 20 minutes on, 5 minutes off 35 °C to 55 °C; >10 A to 20 A, 30 seconds on, 5 minutes off.

Change #4, 606

On page 39, in Table 8, remove the MP14 row from the table. This Part Number 831933 is no longer a replaceable part.

On page 41, in Figure 12, remove the MP14 from the Replaceable Parts.