

FLUKE®

714C

Thermocouple Calibrator

Users Manual

January 2014

© 2014 Fluke Corporation. All rights reserved. Specifications are subject to change without notice.

All product names are trademarks of their respective companies.

LIMITED WARRANTY AND LIMITATION OF LIABILITY

This Fluke product will be free from defects in material and workmanship for three years from the date of purchase. This warranty does not cover fuses, disposable batteries, or damage from accident, neglect, misuse, alteration, contamination, or abnormal conditions of operation or handling. Resellers are not authorized to extend any other warranty on Fluke's behalf. To obtain service during the warranty period, contact your nearest Fluke authorized service center to obtain return authorization information, then send the product to that Service Center with a description of the problem.

THIS WARRANTY IS YOUR ONLY REMEDY. NO OTHER WARRANTIES, SUCH AS FITNESS FOR A PARTICULAR PURPOSE, ARE EXPRESSED OR IMPLIED. FLUKE IS NOT LIABLE FOR ANY SPECIAL, INDIRECT, INCIDENTAL OR CONSEQUENTIAL DAMAGES OR LOSSES, ARISING FROM ANY CAUSE OR THEORY. Since some states or countries do not allow the exclusion or limitation of an implied warranty or of incidental or consequential damages, this limitation of liability may not apply to you.

Fluke Corporation
P.O. Box 9090
Everett, WA 98206-9090
U.S.A.

Fluke Europe B.V.
P.O. Box 1186
5602 BD Eindhoven
The Netherlands

Table of Contents

Title	Page
Introduction	1
How to Contact Fluke	1
Safety Information	3
Safe Working Practices	3
Standard Equipment.....	5
Input and Output Terminals	7
Keys	9
Display	11
Auto Power-Off.....	13
Auto Backlight-Off	13
Display Contrast Adjustment	13
Magnet Mounting and Hanging Strap.....	14
Measure mA Current and Activate Loop Power Supply	15
Measure mA Current	15
Activate Loop Power Supply.....	15
Measure Temperature.....	16
Use Thermocouples	16
Set Temperature Unit	16
Simulate Thermocouples.....	20

Scale mA Channel to Temperature.....	22
Set 0 % and 100 % Output Parameters.....	22
Step and Ramp Modes.....	23
Select Step or Ramp Mode.....	23
Set Step and Ramp Range.....	23
Auto Storage of Settings.....	23
Replace the Batteries.....	24
Maintenance.....	25
Clean the Product.....	25
Service Center Calibration or Repair.....	25
Replacement Parts.....	26
Specifications.....	28
Thermocouple mV Input.....	28
Thermocouple mV Output.....	28
Thermocouple mA Input.....	28
Thermocouple Input and Output.....	29
Loop Power Supply.....	31
General Specifications.....	32

List of Tables

Table	Title	Page
1.	Summary of Source and Measure Functions	2
2.	International Symbols	4
3.	Input/Output Terminals and Connectors	8
4.	Key Functions	10
5.	Elements on the Display	12
6.	Thermocouple Types Accepted	17
7.	Replacement Parts	26

List of Figures

Figure	Title	Page
1.	Standard Equipment.....	6
2.	Input/Output Terminals and Connectors.....	7
3.	Keys	9
4.	Elements of a Typical Display	11
5.	Magnet Mounting with Hanging Strap	14
6.	Connections for Supplying Loop Power	15
7.	Measure Temperature with a Thermocouple.....	19
8.	Connections for Simulating a Thermocouple.....	21
9.	Replace the Batteries	24
10.	Replacement Parts.....	27

Introduction

The Fluke 714C Thermocouple Calibrator (the Product) is a handheld, battery-operated instrument that measures and sources a variety of thermocouples. It also has an isolated channel to measure 4-20 mA (with loop power option). See Table 1.

How to Contact Fluke

To contact Fluke, call one of the following telephone numbers:

- Technical Support USA: 1-800-44-FLUKE (1-800-443-5853)
- Calibration/Repair USA: 1-888-99-FLUKE (1-888-993-5853)

- Canada: 1-800-36-FLUKE (1-800-363-5853)
- Europe: +31 402-675-200
- Japan: +81-03-6714-3114
- Singapore: +65-6799-5566
- Mainland China: +86-400-810-3435
- Anywhere in the world: +1-425-446-5500

Or, visit Fluke's website at www.fluke.com.

To register your product, visit <http://register.fluke.com>.

To see, print, or download the latest manual supplement, visit <http://us.fluke.com/usen/support/manuals>.

Table 1. Summary of Source and Measure Functions

Function	Measure	Source
Thermocouple and mV	Types E, J, K, T, B, R, S, L, U, N, C (W5Re/W26Re), BP, XK, G, D, P, M and mV	
Other functions	Loop power supply, Step, Ramp	

Safety Information

A **Warning** identifies conditions and procedures that are dangerous to the user. A **Caution** identifies conditions and procedures that can cause damage to the Product or the equipment under test.

International electrical symbols used on the Product and in this manual are explained in Table 2.

Safe Working Practices

Review the safety information and comply with the safe working practices.

⚠⚠ Warning

To prevent possible electrical shock, fire, or personal injury:









- **Carefully read all instructions.**
- **Read all safety Information before you use the Product.**
- **Use the Product only as specified, or the protection supplied by the Product can be compromised.**
- **Do not use the Product around explosive gas, vapor, or in damp or wet environments.**
- **Never apply more than 30 V between any two terminals, or between any terminal and earth ground.**

- **Do not connect any test leads to voltages above 30 V when used with the product, even if ratings above 30 V appear on the test leads.**
- **Do not use and disable the Product if it is damaged.**
- **The battery door must be closed and locked before you operate the Product.**
- **Remove all probes, test leads, and accessories before the battery door is opened.**
- **Remove the input signals before you clean the Product.**
- **Have an approved technician repair the Product.**
- **Replace the batteries when the low battery indicator shows to prevent incorrect measurements.**

For safe operation and maintenance of the Product:

- **Repair the Product before use if the battery leaks.**
- **Remove the batteries if the Product is not used for an extended period of time, or if stored in temperatures above 50 °C. If the batteries are not removed, battery leakage can damage the Product.**

Table 2. International Electrical Symbols

	Earth Ground		Battery
	Conforms to relevant Australian Standards.		Risk of danger. Important information. See Manual.
	Inspected and licensed by TÜV Product Services.		Conforms to European Union directives.
CAT II	MEASUREMENT CATEGORY II is applicable to test and measuring circuits connected directly to utilization points (socket outlets and similar points) of the low voltage MAINS installation.	CAT III	MEASUREMENT CATEGORY III is applicable to test and measuring circuits connected to the distribution part of the building's low-voltage MAINS installation.
CAT IV	MEASUREMENT CATEGORY IV is applicable to test and measuring circuits connected at the source of the building's low voltage MAINS installation.		Conforms to relevant North American Safety Standards.
	This product complies with the WEEE Directive (2002/96/EC) marking requirements. The affixed label indicates that you must not discard this electrical/electronic product in domestic household waste. Product Category: With reference to the equipment types in the WEEE Directive Annex I, this product is classed as category 9 "Monitoring and Control Instrumentation" product. Do not dispose of this product as unsorted municipal waste. Go to Fluke's website for recycling information.		

Standard Equipment

The items listed below and shown in Figure 1 are included with your Product. If the Product is damaged or something is missing, contact the place of purchase immediately. To order replacement parts or spares, see the user-replaceable parts list in Table 7.

- AC175 alligator clips (1 set)
- TL75 test leads (1 set)
- TC Cap for TC hole
- Mini standard TC plugs (with 80cm TC wire) package (Including Type K)
- 4 AA batteries
- Magnet Strap TPAK
- *712C/714C Safety Sheet*
- *714C Quick Reference Guide*
- *714C Users Manual (available on Fluke's website)*

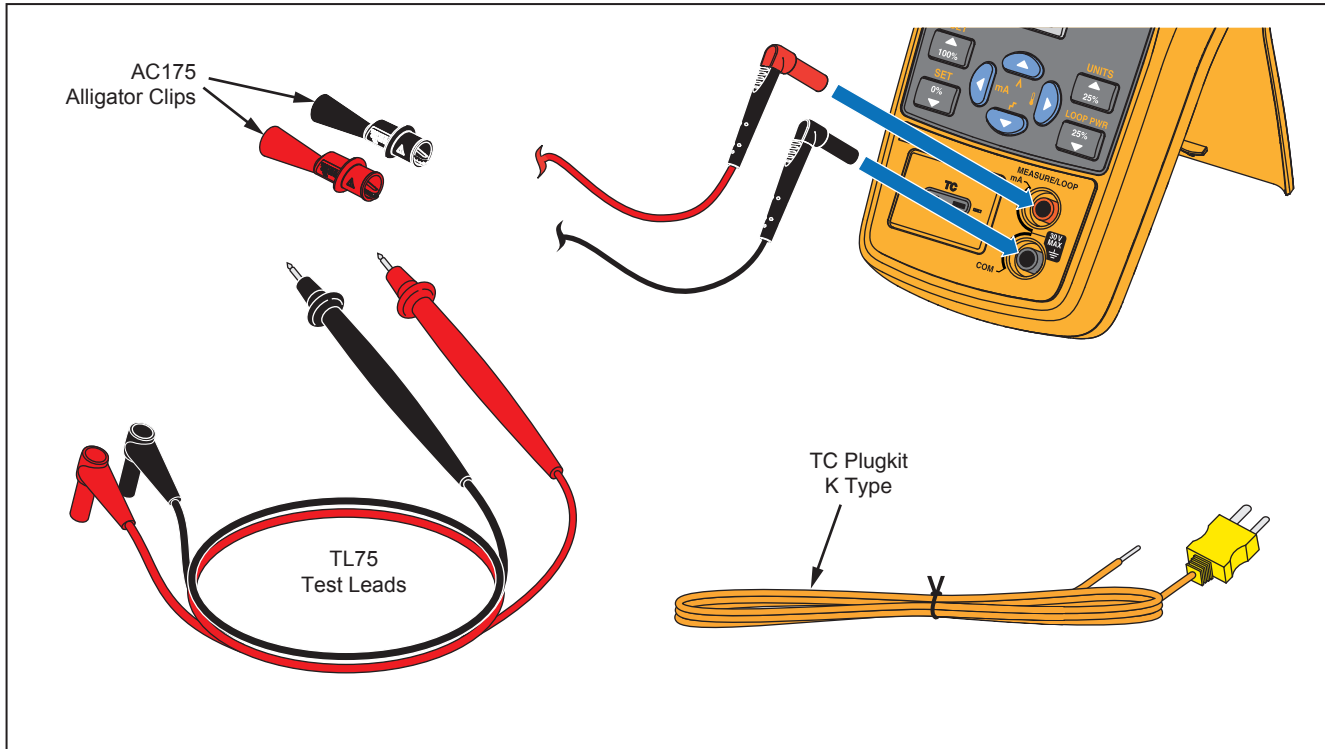
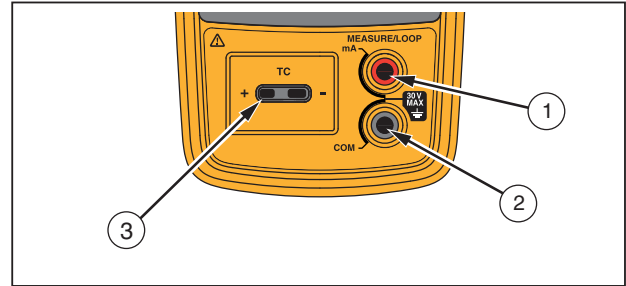

Figure 1. Standard Equipment

hnj01.eps

Input and Output Terminals

Figure 2 shows the input and output terminals on the Product. Table 3 explains their use.



hnj02.eps

Figure 2. Input/Output Terminals and Connectors

Table 3. Input/Output Terminals and Connectors

No.	Name	Description
①, ②	MEASURE mA terminals	Input terminals for measuring current and supplying loop power.
③	TC input/output	Terminal for measuring or simulating thermocouples. This terminal accepts a miniature polarized thermocouple plug with flat, in-line blades spaced 7.9 mm (0.312 in.) center to center.

Keys

The Product has keys for different purposes. Some keys have secondary functions that are available when SHIFT already shows on the display.









Figure 3 shows the Product keys and Table 4 explains their use.



hnj03.eps

Figure 3. Keys

Table 4. Key Functions

No.	Name	Description
①		Turns the power on or off.
②		Shifts to secondary function when pushed before other keys (Shift mode).
③		Turns backlight on or off.
④		Increments output by 25 % of span. Secondary function: toggles between temperature units (°C or °F.).
⑤		Decreases output by 25 % of span. Secondary function: activates a 24 V loop power supply.
⑥		Up/down arrow increases or decreases the source level. Cycles through different options. Secondary functions: Enters Ramp or Step mode. Left/right arrow cycles through and highlights the field to be edited. In contrast adjustment mode; left- lightens contrast, right- darkens contrast. Secondary functions: Left arrow enters mA measurement; right arrow enters temperature measurement.
⑦		Sets a source value to 100 % or 0 % of span. Secondary function: enables automatic value span of 100 % or 0 %.
⑧		Shifts between Measure and Source modes.
⑨		Selects TC (thermocouple) measurement and sourcing function.

Display

Figure 4 shows the elements of a typical display. Table 5 describes the elements.

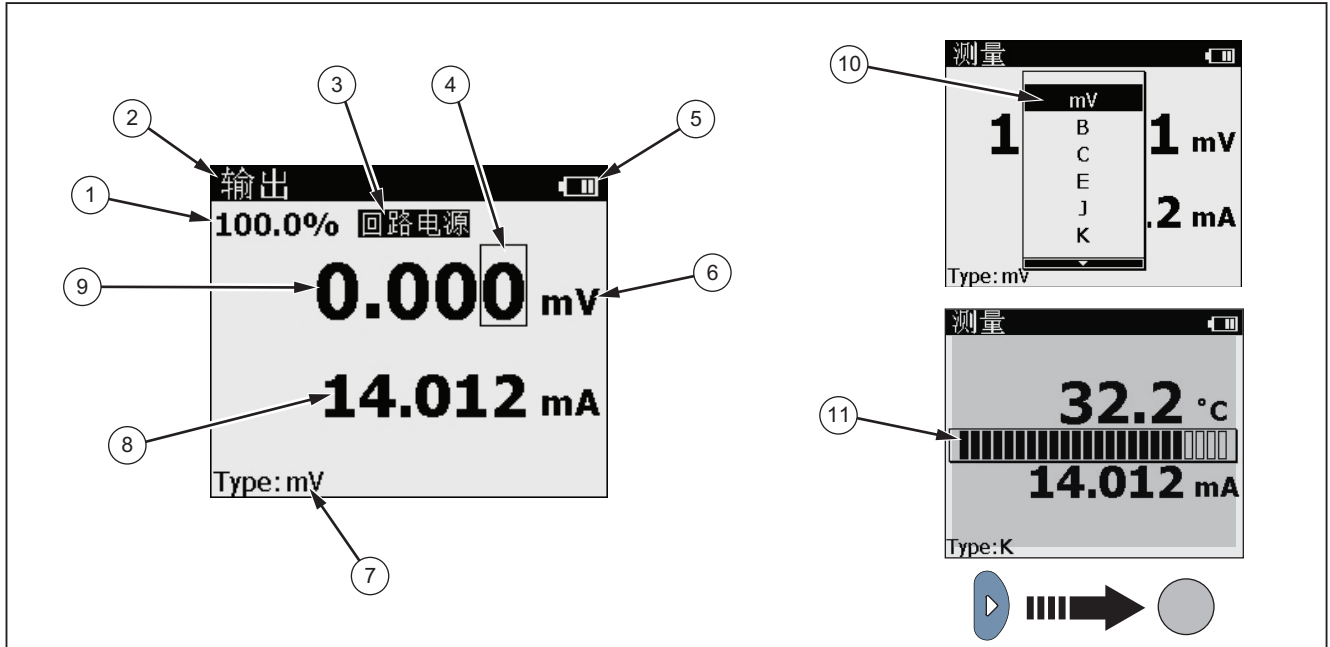

Figure 4. Elements of a Typical Display

hnj15.eps

Table 5. Elements on the Display

Item No.	Description
①	100 % of value span
②	Source or Measure mode
③	LOOP POWER icon
④	Selected digit that can be edited
⑤	Battery usage status
⑥	Unit of voltage
⑦	Selected TC type
⑧	mA reading
⑨	Voltage reading
⑩	TC type list
⑪	Display contrast bar

Auto Power-Off

The Product provides an auto power-off function to save power. When the auto power-off mode is enabled, the Product automatically powers off after 15 minutes of inactivity.

To enable the auto power-off mode:

1. Push .
2. When SHIFT shows on the display, push TC TYPE.
3. In the displayed setting list, highlight the **Auto poweroff** option, and then use **▶** to select this option.

To disable the the auto power-off mode:

1. Push .
2. When SHIFT shows on the display, push TC TYPE.
3. In the displayed setting list, highlight the **Auto poweroff** option, and then use **▶** to deselect this option.

Display Contrast Adjustment

The Product allows you to adjust the display contrast.

To adjust the display contrast:

1. Push MEASURE SOURCE until Measure shows on the display.
2. Push **▶** to darken contrast, or **◀** to lighten contrast.

Auto Backlight-Off

The Product provides an auto backlight-off function to save power. When the auto backlight-off mode is enabled, the backlight automatically turns off after 2 minutes of inactivity.

To enable the auto backlight-off mode:

1. Push .
2. When SHIFT shows on the display, push TC TYPE.
3. In the displayed setting list, highlight the **Auto backlight off** option, and then use **▶** to select this option.

To disable the the auto backlight-off mode:

1. Push .
2. When SHIFT shows on the display, push TC TYPE.
3. In the displayed setting list, highlight the **Auto backlight off** option, and then use **▶** to deselect this option.

Magnet Mounting and Hanging Strap

The Product has a magnet on the rear of the unit. It is removable. This magnet enables users to mount the Product on metal environment and free their hands.

In addition, this Product has a hanging strap on the magnet. Besides its hanging purpose, the strap connects the magnet and the Product to avoid losing the magnet. This strap is also removable.

Figure 5 shows the magnet mounting of the Product with the hanging strap.

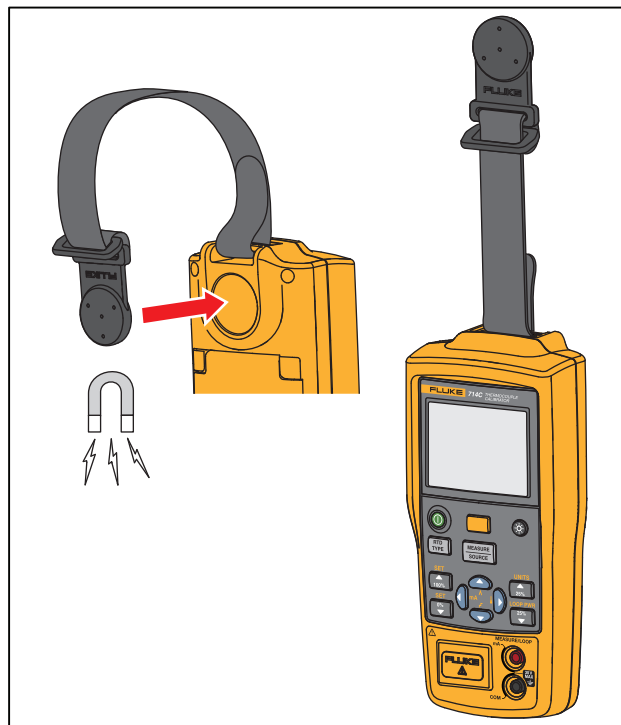

hnj16.eps

Figure 5. Magnet Mounting with Hanging Strap

Measure mA Current and Activate Loop Power Supply

The Product lets you measure mA current. It also has a loop power function that activates a 24 V supply in series with the current measuring circuit. This allows you to test a transmitter when it is disconnected from plant wiring.

⚠ Caution



To prevent impact to the measurement function, do not use the Product to measure current near strong magnetic fields.

Measure mA Current

To measure mA current, connect the Product to the transmitter current terminals, as shown in Figure 6.

Activate Loop Power Supply

To activate loop power supply:

1. Push .
2. When SHIFT shows on the display, push .

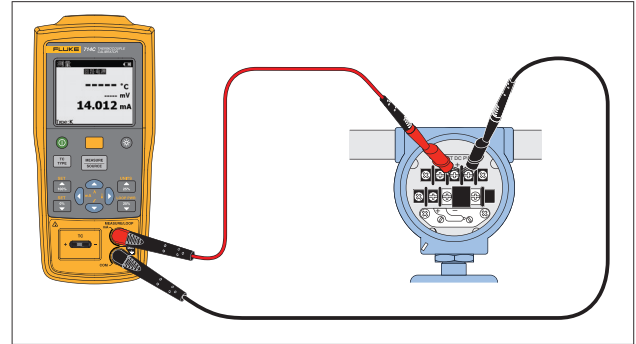

An internal 24 V loop power turns on.



hnj06.eps

Figure 6. Connections for Supplying Loop Power

To turn off loop power supply:

1. Push .
2. When SHIFT shows on the display, push .

The internal 24 V loop power turns off.

Measure Temperature

Use Thermocouples

The Product supports 17 standard thermocouples, including types E, N, J, K, T, B, R, S, L, U, C (W5Re/W26Re), BP, XK, G, D, P, or M. Table 6 summarizes the ranges and characteristics of the supported thermocouples.



To measure temperature using a thermocouple, proceed as follows:

1. Attach the thermocouple leads to the appropriate TC miniplug, then to the TC input/output as shown in Figure 7.

Note



One pin is wider than the other. Do not try to force a miniplug in the wrong polarization.

If the Product and the thermocouple plug are at different temperatures, wait one minute or more for the connector temperature to stabilize after you plug the miniplug into the TC input/output.

2. If necessary, push  for MEASURE mode.
3. Push  for the TC display. If desired, continue pushing this key to select the desired thermocouple type.

Set Temperature Unit

The Product allows you to select the temperature unit °C or °F.

Push  to switch to shift mode, and push  to set the temperature unit to °C or °F.

The default temperature unit is °C.

Table 6. Thermocouple Types Accepted

Type	Positive Lead Material	Specified Range (°C)	Positive Lead (H) Color		Negative Lead Material
			ANSI*	IEC**	
E	Chromel	-250 to 1000	Purple	Violet	Constantan
N	Ni-Cr-Si	-200 to 1300	Orange	Pink	Ni-Si-Mg
J	Iron	-210 to 1200	White	Black	Constantan
K	Chromel	-200 to 1372	Yellow	Green	Alumel
T	Copper	-250 to 400	Blue	Brown	Constantan
B	Platinum - 30 % Rhodium	600 to 1820	Gray		Platinum - 6 % Rhodium
R	Platinum - 13 % Rhodium	-20 to 1767	Black	Orange	Platinum
S	Platinum - 10 % Rhodium	-20 to 1767	Black	Orange	Platinum
C	Tungsten - 5% Rhenium	0 to 2316	White	None	Tungsten - 26 % Rhenium
L	Iron	-200 to 900			Constantan
U	Copper	-200 to 400			Constantan
BP	90.5 % Ni - 9.5 % Cr	0 to 2500	GOST		56 % Cu - 44 % Ni
			Violet or Black		
XK	95 % W - 5 % Re	-200 to 800	Red or Pink		80 % W - 20 % Re
G	Tungsten	100 to 2315	White		Tungsten - 26 % Rhenium

714C*Users Manual*

D	Tungsten - 3 % Rhenium	0 to 2315	White	Tungsten - 25 % Rhenium
P	Platinel 5355	0 to 1395		Platinel 7674
M	Nickel – 18 % Molybdenum	-50 to 1410		Nickel - 0.8 % Cobalt
<p>*American National Standards Institute (ANSI) device negative lead (L) is always red.</p> <p>**International Electrotechnical Commission (IEC) device negative lead (L) is always white.</p>				

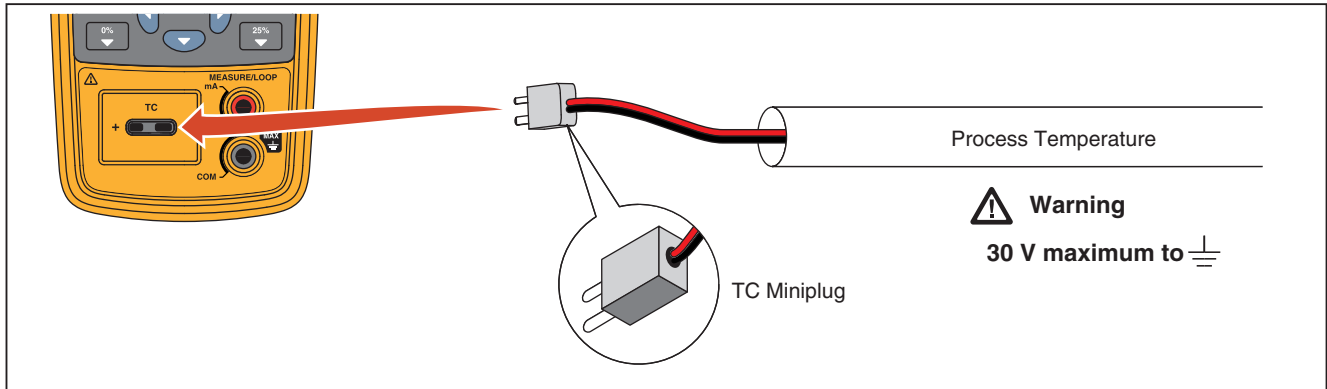

Figure 7. Measure Temperature with a Thermocouple

hnj14.eps







Simulate Thermocouples

Connect the Product TC input/output to the instrument under test with thermocouple wire and the appropriate thermocouple mini-connector (polarized thermocouple plug with flat, in-line blades spaced 7.9 mm [0.312 in] center to center).

Note

One pin is wider than the other. Do not try to force a miniplug in the wrong polarization. Figure 8 shows this connection.

Proceed as follows to simulate a thermocouple:

1. Attach the thermocouple leads to the appropriate TC miniplug, then to the TC input/output as shown in Figure 8.
2. If necessary, push  for Source mode.
3. Push  for the TC display. If desired, continue pushing this key to select the desired thermocouple type or mV.
4. Enter the value you want by pushing  and . Push  and  to select a different digit to edit.

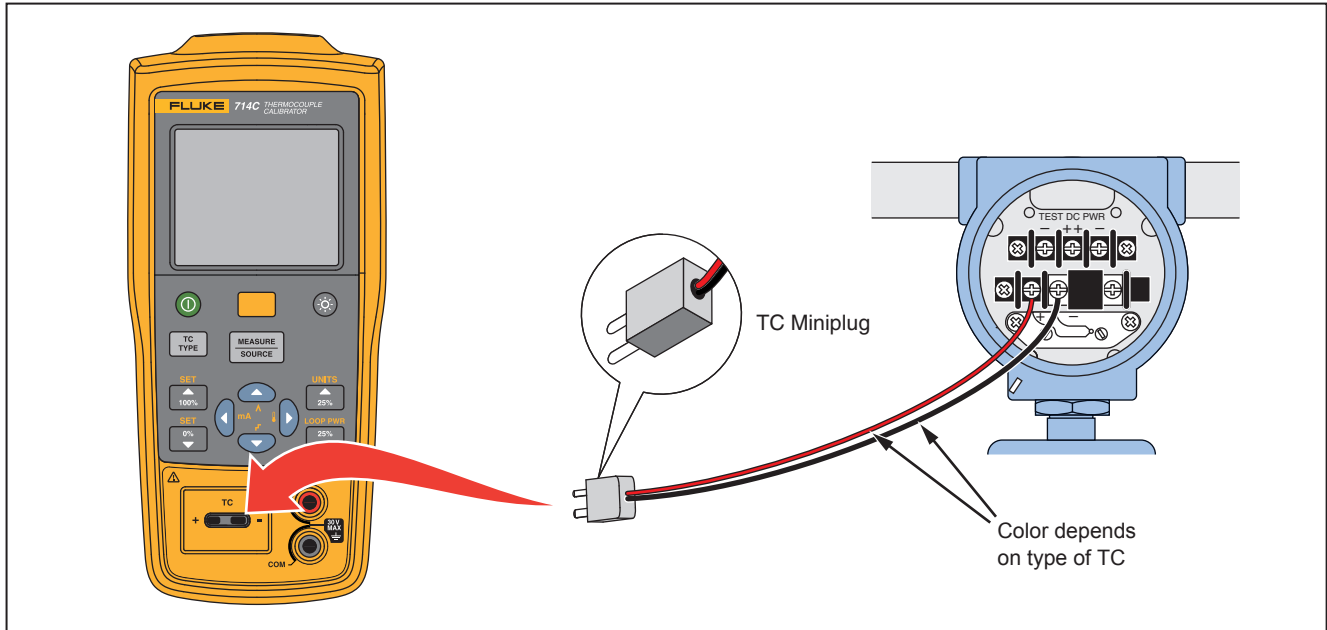

Figure 8. Connections for Simulating a Thermocouple

hnj10.eps

Scale mA Channel to Temperature

The Product provides a function to convert mA current channel reading to temperature reading.

To scale mA channel to temperature:

1. Push .
2. Push **0**.

The temperature reading shows on the display.

To switch back to mA channel:

1. Push .
2. Push **0**.

The mA current reading shows on the display.

Note

Temperature at 4 mA = Span check 0 %

Temperature at 20 mA = Span check 100 %

Set 0 % and 100 % Output Parameters

You must set the 0 % and 100 % points before you can use the step and ramp functions or use mA/temperature conversion. Proceed as follows:

1. If necessary, push for Source mode.
2. Push and use the arrow keys to enter the correct type.
3. Use the arrow keys to adjust the value.
4. Push and (or) to set 100 % and 0 % value.

Note

This function is only available when Source mode is selected.



Step and Ramp Modes

Select Step or Ramp Mode

The Product allows you to set Step and Ramp modes for easier check of points within the linear range in Source mode.

To set the Step or Ramp mode:





1. Push .
2. Use  and  to select Step mode or Ramp mode.

The  or  icon shows on the Product display accordingly.

Note

This function is only available when Source mode is selected.

Set Step and Ramp Range

In Source mode, set the temperature value and hold , , , or  3s to set the Step and Ramp value.

Auto Storage of Settings

The Product automatically stores the latest settings, including the temperature unit, the linear range of mA converting to temperature, and sensor type.

Every time you turn on the Product, it automatically applies the last settings.

Replace the Batteries

Warning

To prevent false readings, which could lead to possible electric shock or personal injury, replace the batteries as soon as the low battery indicator appears.

Figure 9 shows you how to replace the batteries.

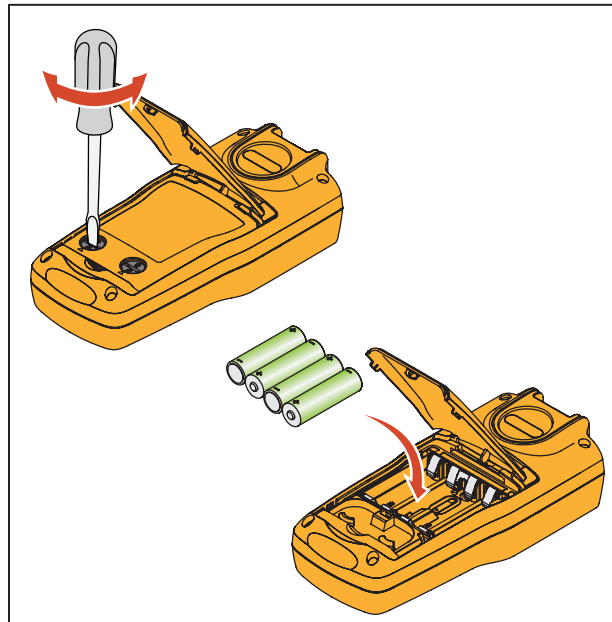

hnh38.eps

Figure 9. Replace the Batteries

Maintenance

Clean the Product

Warning

To prevent personal injury or damage to the Product, use only the specified replacement parts and do not allow water into the case.

Caution

To prevent damage to the plastic lens and case, do not use solvents or abrasive cleansers.

Clean the Product with a soft cloth dampened with water or water and mild soap.

Service Center Calibration or Repair

Calibration, repairs, or servicing not covered in this manual should be performed only by qualified service personnel. If the Product fails, check the batteries first, and replace them if needed.

Verify that the Product is being operated in accordance with the instructions in this manual. If the Product is faulty, send a description of the failure with the Product. Be sure to pack the Product securely, using the original shipping container if it is available. Send the equipment postage paid and insured, to the nearest Service Center. Fluke assumes no responsibility for damage in transit.

To locate an authorized service center, refer to “How to Contact Fluke” at the beginning of the manual.

Replacement Parts

Table 7. Replacement Parts

Item	Description	PN	Qty.
①	Case top	4312903	1
②	Decal on case top	4312926	1
③	TC cap	4369726	1
④	Keypad	4307158	1
⑤	Keypad support	4307112	1
⑥	Screw, M2.2 x 0.8, 5 mm, PAN, Philips	2032777	12
⑦	TC plate	4307381	1
⑧	Screw, M3-0.5 x 5 mm, Philips	2032811	2
⑨	LCD mask	4307251	1
⑩	LCD protect rubber	4307208	1
⑪	LCD	4313462	1

Table 7 lists the part number of each replaceable part. Refer to Figure 10.

⑫	Support LCD gasket	4307213	1
⑬	Case seal rubber	4307186	1
⑭	Case bottom assembly	4307079	1
⑮	Screw, M3, 13.5 mm, PAN, Philips	2388382	6
⑯	Battery door seal rubber	4307199	1
⑰	AA battery	376756	4
⑱	Pad, battery door	4417921	1
⑲	Battery door assembly	4376901	1
⑳	Bail stand	4307093	1
㉑	Quick Reference Guide	4389376	1
㉒	TC plugkit, K type	773135	1
--	Test Leads, not shown	variable ^[1]	1 set
--	Alligator Clips, not shown	variable ^[1]	1 set

[1] See www.fluke.com for more information about the test leads and alligator clips available for your region.

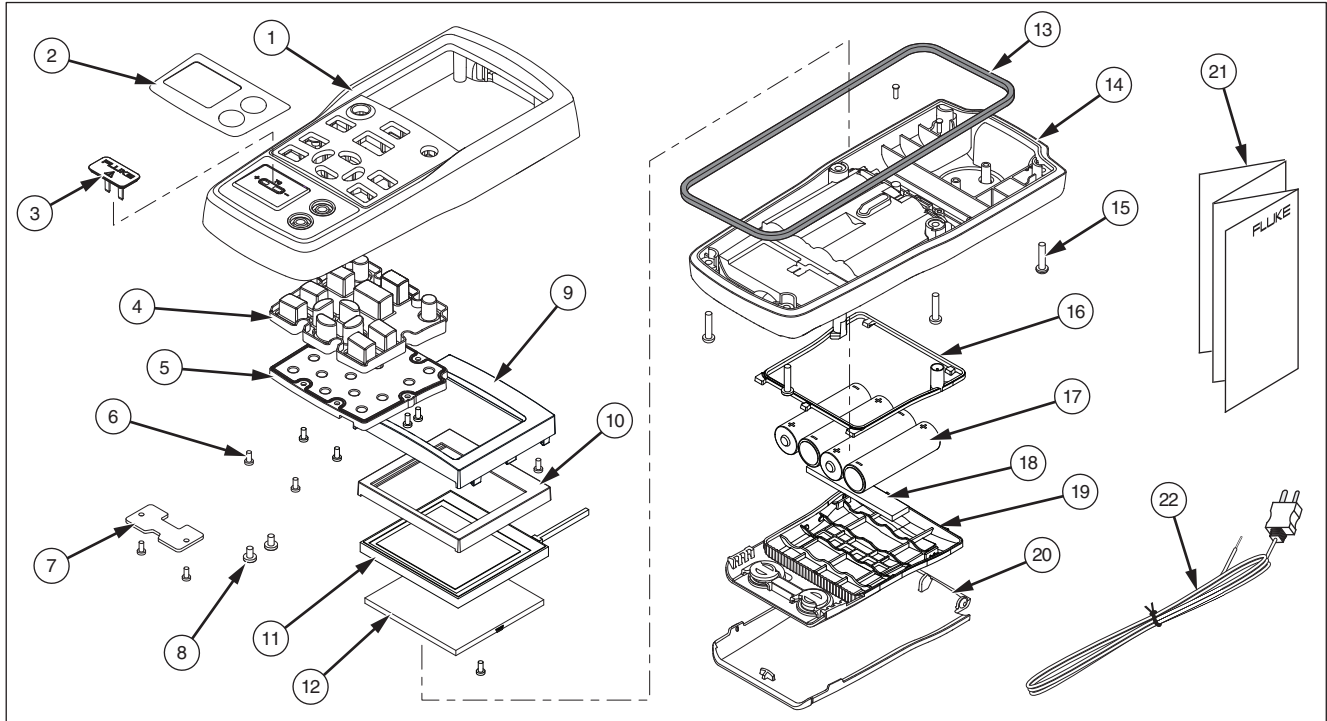

Figure 10. Replacement Parts

hnj46.eps

Specifications

Specifications are based on a one year calibration cycle and apply from +18 °C to +28 °C unless stated otherwise. All specifications assume a 5 minute warmup period.

Thermocouple mV Input

Range	Resolution	Accuracy (% of Reading + Floor)	
		1 year	2 year
-10 mV to 75 mV	0.001 mV	0.015 % + 10 μ V	0.02% + 15 μ V
Temperature coefficient: $\pm(0.002\%$ of reading + 0.002 % of range) /°C (<18°C or >28°C)			

Thermocouple mV Output

Range	Resolution	Accuracy (% of Output +Floor)	
		1 year	2 year
-10 mV to 75 mV	0.01 mV	0.015 % + 10 μ V	0.02 % + 15 μ V
Temperature Coefficient: $\pm(0.002\%$ of output + 0.002 % of range) /°C (<18 °C or >28 °C)			

mA Input

Range	Resolution	Accuracy (% of Reading + Floor)	
		1 year	2 year
0 mA to 24 mA	0.001 mA	0.01 % + 2 μ A	0.02 % + 4 μ A
Temperature Coefficient: $\pm(0.002\%$ of output + 0.002 % of range) /°C (<18 °C or >28 °C)			

Thermocouple Input and Output

TC Type	Range	Measure (°C)		Source (°C)	
		1 year	2 year	1 year	2 year
E	-250 to 200	1.3	2.0	0.6	0.9
	-200 to -100	0.5	0.8	0.3	0.4
	-100 to 600	0.3	0.4	0.3	0.4
	600 to 1000	0.4	0.6	0.2	0.3
N	-200 to -100	1.0	1.5	0.6	0.9
	-100 to 900	0.5	0.8	0.5	0.8
	900 to 1300	0.6	0.9	0.3	0.4
J	-210 to -100	0.6	0.9	0.3	0.4
	-100 to 800	0.3	0.4	0.2	0.3
	800 to 1200	0.5	0.8	0.3	0.3
K	-200 to -100	0.7	1.0	0.4	0.6
	-100 to 400	0.3	0.4	0.3	0.4
	400 to 1200	0.5	0.8	0.3	0.4
	1200 to 1372	0.7	1.0	0.3	0.4
T	-250 to -200	1.7	2.5	0.9	1.4
	-200 to 0	0.6	0.9	0.4	0.6
	0 to 400	0.3	0.4	0.3	0.4

B	600 to 800	1.3	2.0	1.0	1.5
	800 to 1000	1.0	1.5	0.8	1.2
	1000 to 1820	0.9	1.3	0.8	1.2
R	-20 to 0	2.3	2.8	1.2	1.8
	0 to 100	1.5	2.2	1.1	1.7
	100 to 1767	1.0	1.5	0.9	1.4
S	-20 to 0	2.3	2.8	1.2	1.8
	0 to 200	1.5	2.1	1.1	1.7
	200 to 1400	0.9	1.4	0.9	1.4
	1400 to 1767	1.1	1.7	1.0	1.5
C (W5Re/W26Re)	0 to 800	0.6	0.9	0.6	0.9
	800 to 1200	0.8	1.2	0.7	1.0
	1200 to 1800	1.1	1.6	0.9	1.4
	1800 to 2316	2.0	3.0	1.3	2.0
L	-200 to -100	0.6	0.9	0.3	0.4
	-100 to 800	0.3	0.4	0.2	0.3
	800 to 900	0.5	0.8	0.2	0.3
U	-200 to 0	0.6	0.9	0.4	0.6
	0 to 600	0.3	0.4	0.3	0.4
BP	0 to 1000	1.0	1.5	0.4	0.6
	1000 to 2000	1.6	2.4	0.6	0.9
	2000 to 2500	2.0	3.0	0.8	1.2
XK	-200 to 300	0.2	0.3	0.2	0.5
	300 to 800	0.4	0.6	0.3	0.6

**Thermocouple Calibrator
Specifications**

G	100 to 300	1.6	2.4	1.2	1.8
	300 to 1500	1.0	1.5	1.0	1.5
	1500 to 2315	2.0	3.0	1.6	2.4
D	0 to 300	1.6	2.4	1.2	1.8
	300 to 1500	1.0	1.5	1.0	1.5
	1500 to 2315	2.0	3.0	1.6	2.4
P	0 to 1000	1.6	2.4	0.6	0.9
	1000 to 1395	2.0	3.0	0.8	1.2
M	-50 to 100	1.0	1.5	0.4	0.6
	100 to 1000	1.6	2.4	0.6	0.9
	1000 to 1410	2.0	3.0	0.8	1.2

- 1) Sensor inaccuracies not included.
- 2) Accuracy with external cold junction; for internal junction add 0.2 °C
- 3) Temperature scale: ITS-90
Compensation: NIST Monograph 175 for B, R, S, E, J, K, N, T. DIN 43710 for L, U. GOST P 8.585-2001 (Russia) for BP and XK. ASTM E988-96 for C (W5Re/W26Re). ASTM E1751/E1751M – 09ε1 for G, D, P, M
- 4) Resolution: 0.1 °C
- 5) Temperature Coefficient: 0.05 °C/°C (<18 °C or >28 °C)
0.07 °C/°C for C type >1800 °C and for BP type >2000 °C

Loop Power Supply

Open circuit voltage: 24 V ±10 %

Loaded circuit voltage: 18 V minimum at 20 mA current

Short circuit protected

General Specifications

Maximum voltage applied between any terminal and earth ground or between any two terminals:	30 V
Operating temperature	-10 °C to 50 °C
Storage temperature	-20 °C to 60 °C
Operating altitude	2,000 meters
Storage altitude	12,000 meters
Relative Humidity (% RH operating without condensation)	Non condensing 90 % (10 °C to 30 °C) 75 % (30 °C to 40 °C) 45 % (40 °C to 50 °C)
Vibration Requirements	MIL-T-28800E, Class 2
Drop Test Requirements	1 meter
IP Rating	IEC 60529: IP52 (with TC cap)
Electromagnetic Environment	IEC 61326-1, Portable
Safety	IEC 61010-1, Max 30 V to earth, Pollution Degree 2
Power Supply	4 AA NEDA 15A IEC LR6 batteries
Size (H x W x L)	52.5 x 84 x 188.5 mm
Weight	515 g