

Manual Supplement

Manual Title: 1736/1738 Users

Print Date: September 2015

Revision/Date: 1, 7/17

Supplement Issue: **4**

Issue Date: 7/19

Page Count: 10

This supplement contains information necessary to ensure the accuracy of the above manual.

Change #1, 381

On the Cover, add the **BC** Symbol.

On page 4, add the following to the **Symbols** table:

	Conforms to the Appliance Efficiency Regulation (California Code of Regulations, Title 20, Sections 1601 through 1608), for small battery charging systems.
---	---

Change #2, 491

On page 6, replace Figure 1 with:

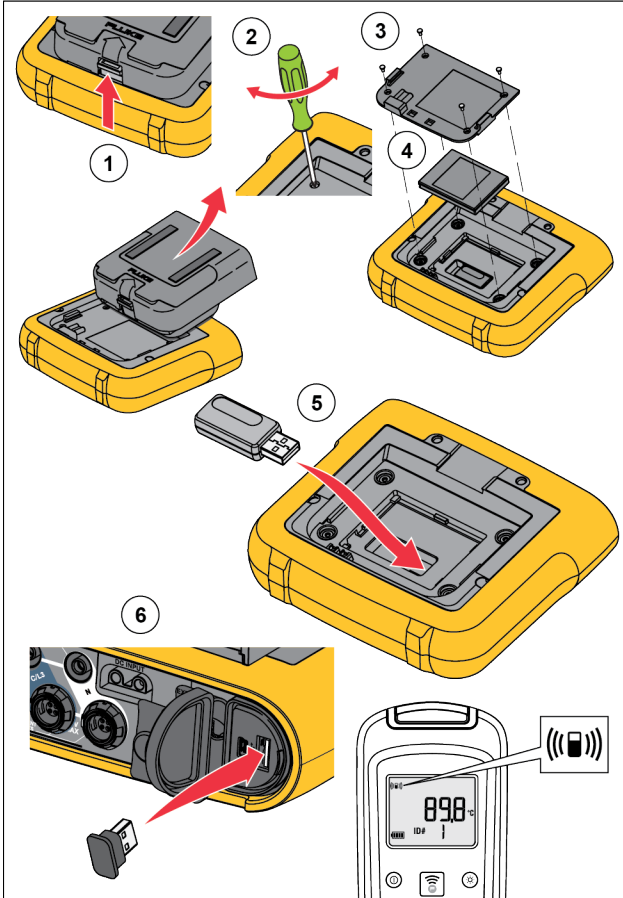

hcf069.eps

Figure 1. Adapter Installation

Change #3, 594

On page 16, replace the **Measurement Line Power Source** section with:

Measurement Line Power Source:

⚠⚠ Warning

To prevent injury, do not touch the metal parts of one test lead when the other is still connected to hazardous voltage.

⚠ Caution

To prevent damage to the Product, make sure the measured voltage does not exceed the input rating of the power supply.

1. Attach the power supply to the Logger.
2. Move the slide-cover on the power supply to access the safety sockets.
3. Connect the short test leads (see Figure 7B & 7C) with the power supply inputs. Make sure to use the non-stackable plugs. The test leads are rated for measurement/overvoltage CAT III 1000 V and CAT IV 600 V.
4. Connect the test leads with the voltage measurement inputs:
 - Connect A/L1 with one input of the power supply.
 - Connect N with the second input of the power supply.

OR

- Connect A/L1 with one input of the power supply.
 - Connect B/L2 with the second input of the power supply.
5. Use the short fan out of the Voltage Test Lead, 3-phase + N. Plug the connector A/L1 into the socket A/L1 of the voltage measurement inputs of the Logger. Repeat this with B/L2, C/L3 and N.

- For measurement connection to the Logger (see Figure 7A):

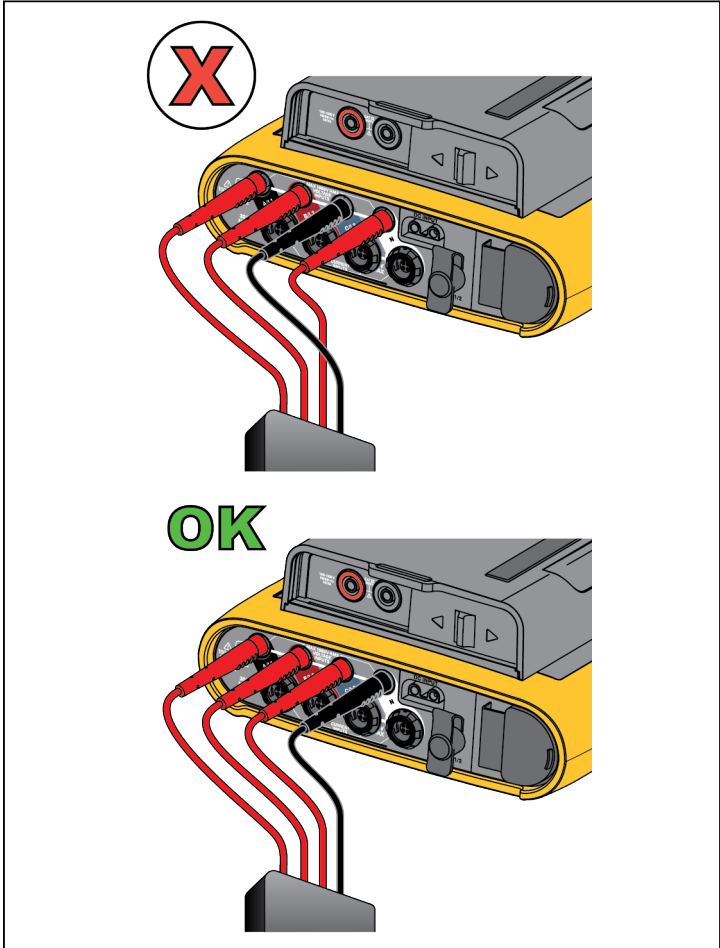

Figure 7A: Measurement connection to the Logger

- To supply power to the Logger from installations with neutral voltage (see Figure 7B):

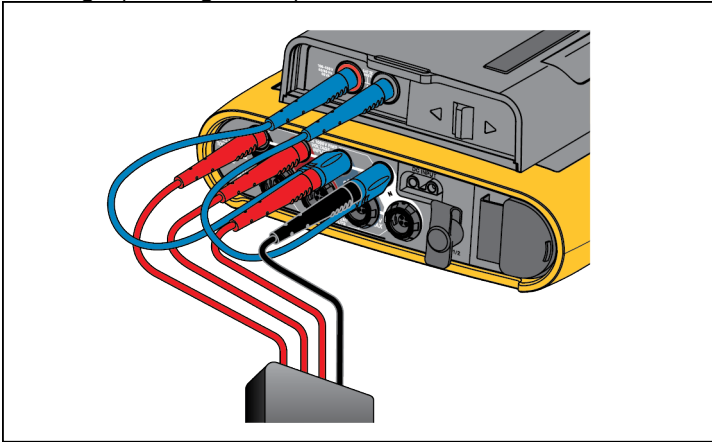

Figure 7B: Measurement with neutral voltage and supplying instrument power.

Note

You must locate and connect an alternate power source to the instrument if the voltage to measure is $<100\text{ V}$ or $>500\text{ V}$. Use the set of 2 m test leads (item 8 in Figure 11) or the supplied power cord.

6. Connect the voltage inputs to the test points.
The Logger automatically turns on and is ready to use in <30 seconds.

- To supply power to the Logger from installations without neutral voltage (see Figure 7C):

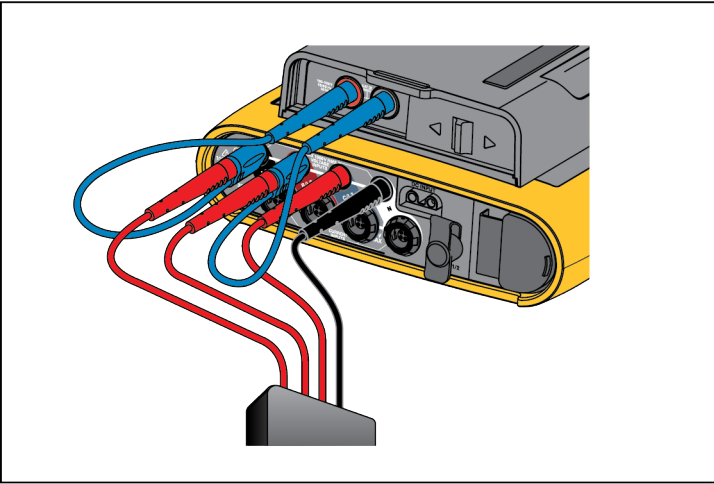

Figure 7C: Measurement without neutral voltage and supplying instrument power.

Note

You must locate and connect an alternate power source to the instrument if the voltage to measure is <100 V or >500 V. Use the set of 2 m test leads (item 8 in Figure 11) or the supplied power cord.

7. Connect the voltage inputs to the test points.
The Logger automatically turns on and is ready to use in <30 seconds.

Change #4, 491, 703

On page 5, replace **Before You Start**, with:

Your purchase includes these items. Carefully unpack and inspect each of the items:

- Energy Logger
- Power Supply
- Voltage Test Lead, 3-phase + N
- 2x Alligator Clips, Blue
- 4x Alligator Clips, Black
- 3x i173x-flex1500 Thin-Flexi Current Probe, 30.5 cm (12 in)
- Set of color-coded Wire Clips
- Mains Power Cable (see Table 2)
- Set of 2 test leads, stack and non-stackable, blue, 18 cm (7 in)
- Set of 2 test leads, non-stackable, blue, 2 m (79 in)
- DC Power Cable
- USB Cable A, Mini-USB
- Soft Storage Bag/Case
- Input Connector Decal (see Table 6)
- Documentation Info Pack (Quick Reference Card, Safety Information)
- USB Flash Drive (includes Users Manual, Fluke Energy Analyze Plus software, and Software Licenses)

Note

The power cord and input connector decal are country specific and vary according to the order destination.

The Energy Logger also includes these items in the standard purchase list:

- WiFi to USB Adapter
- Magnet Hanger Kit
- Set of 4 Magnet Probes for 4 mm Banana Plugs

These items are available for the Energy Logger as optional accessories.

On page 9, replace the first paragraph and Figure 4, with:

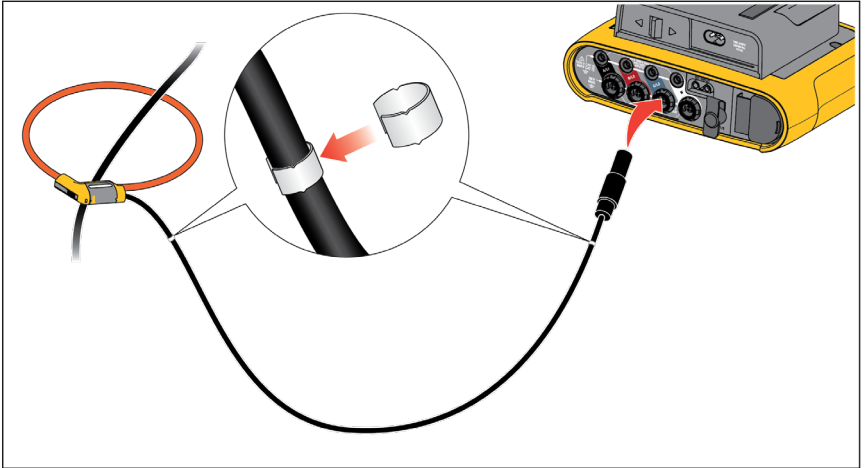

Figure 4. Test Leads with Cable Markers

On page 10, replace Table 3 with:

Table 3. Accessories

Part ID	Description
i17xx-flexi 1500	Thin-Flexi Current Probe (single) 1500 A, 30.5 cm (12 in.)
i17xx-flexi 1500/3PK	Set of 3 Thin-Flexi Current Probes
i17xx-flexi 1500/4PK	Set of 4 Thin-Flexi Current Probes
i17xx-flexi 3000	Thin-Flexi Current Probe (single) 3000 A, 61 cm (24 in.)
i17xx-flexi 3000/3PK	Set of 3 Thin-Flexi Current Probes
i17xx-flexi 3000/4PK	Set of 4 Thin-Flexi Current Probes
i17xx-flexi 6000	Thin-Flexi Current Probe (single) 6000 A, 90.5 cm (36 in.)
i17xx-flexi 6000/3PK	Set of 3 Thin-Flexi Current Probes
i17xx-flexi 6000/4PK	Set of 4 Thin-Flexi Current Probes
i17xx flexi extension cable	Thin-Flexi extension cable (single), 5m (197 in.)
i17xx flexi extension cable/3PK	Set of 3 Thin-Flexi extension cable

i17xx flexi extension cable/4PK	Set of 4 Thin-Flexi extension cable
C17xx	Soft Case
Test Leads 0.18m	0.18 m (7 in.) Test Lead Set, blue
Test Leads 2m with alligator clips	2.0 m (79 in.) Test Lead Set plus 2x alligator clips, blue
Voltage Test Lead 3-phase+N, 2m (79 in.)	3PHVL-17xx Voltage Test Lead 3-phase + N, 2 m (79 in.)
Voltage Test Lead 3-phase+N, 5m (197 in.)	3PHVL-17xx Voltage Test Lead 3-phase + N, 5 m (197 in.)
i40s-EL Current Clamp	40 A (single) Current Clamp
i40s-EL/3PK	Set of 3 Current Clamps, 40 A
i400S-EL	400 A (single) Current Clamp
i400S-EL/3PK	Set of 3 Current Clamps, 400 A
Power Quality Window	PQ-400 Power Quality Window (PQ-400B / PQ-400)
17xx AUX Input Adapter	Auxiliary Input Adapter for up to 2DC voltages (0 V to 10 V and 0 V to 1000 V)
Fused Test Probe Set	Set of 4 Test Probes, three phase, AC285, 1x black, 3x red
MP1-3R Magnet Probe Set	Set of 4 Magnet Probes for 4 mm banana plugs, 1x black, 3x red
BP1730-Battery Pack	BP1730-Battery Pack
Fluke-PQ-Marker	Cable marker set 3 phase + N + PE
Fluke-1730-Hanger Kit	Hanger Kit
Fluke-1732/UPGRADE for EUR/US	Upgrade Kit for 1732 to 1734 (includes: Hanger, Magnet Probes, Bluetooth Adapter, WiFi Adapter, and License Key)
IEEE 519/Report	Software License for IEEE 519 Reporting
FLK-WIFI/BLE	WiFi/BLE to USB Adapter (check with your sales representative for availability)

On page 55, Table 9, replace Ref. 7, 8, 9, and 10 with:

7	Test Leads 0.18 m blue, 1000 V CAT III	1 set	5016873
8	Test Leads 2 M, 2x alligator clips, blue, 1000 V CAT III	1 set	5020006
9	Cable marker	1 set	5046009
10	USB Flash Drive (includes Users Manual, Fluke Energy Analyze Plus software, and Software Licenses)	1	N/A

On page 56, replace Figure 11, with:

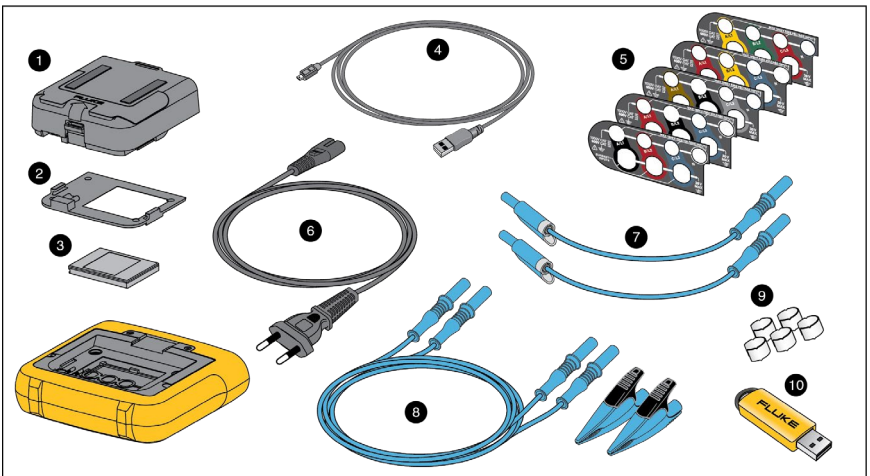

Figure 11. Replacement Parts