

**Product data sheet:
Electric height adjustable desk frame 501-23**

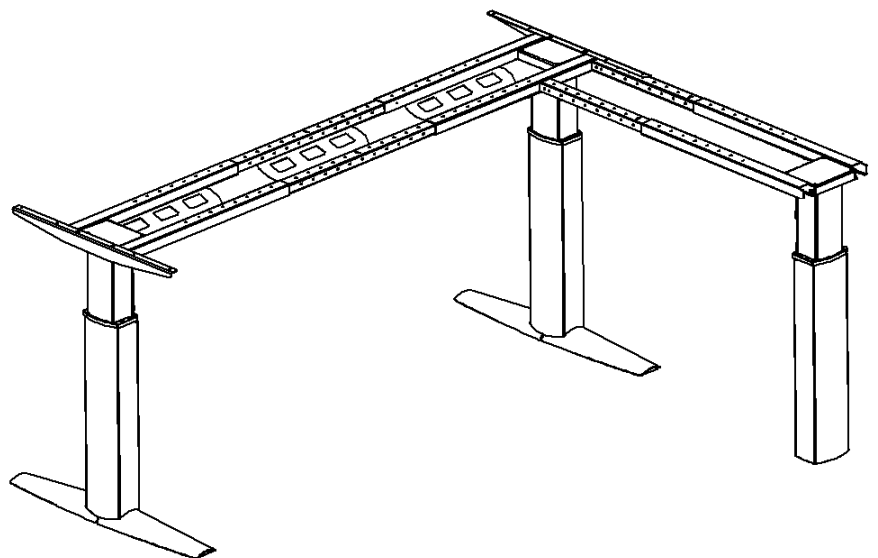
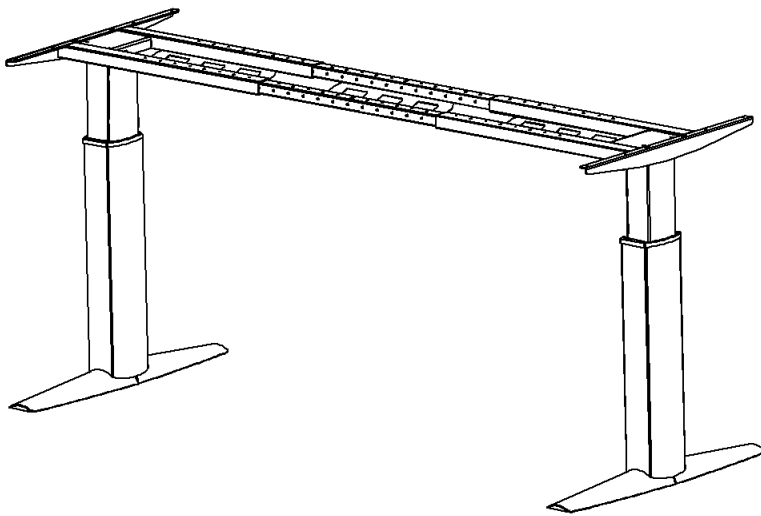
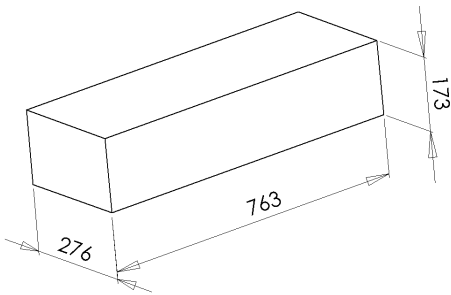

Table of contents

Packing details, 2-column frame	page 3
Packing details, 3-column frame	page 4
Main measures and specifications, 2-column frame	page 5
Main measures and specifications, 3-column frame	page 6
Tabletop drilling, 2-column frames	page 7
Tabletop drilling, 3-column frames	page 8
Assembly and use	page 9
Safety and tests	page 10
Specification, components	page 11

Packing details, 2-column frame

Box Packing



Weight 28 kg

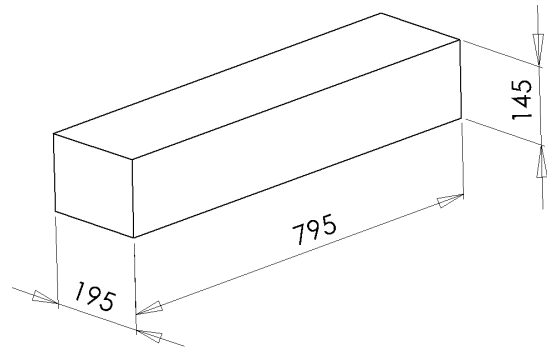

Weight 19 kg



Content of packing

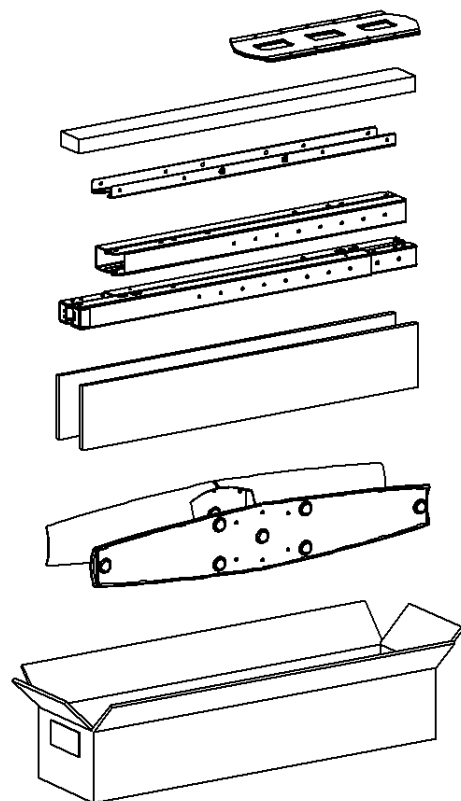
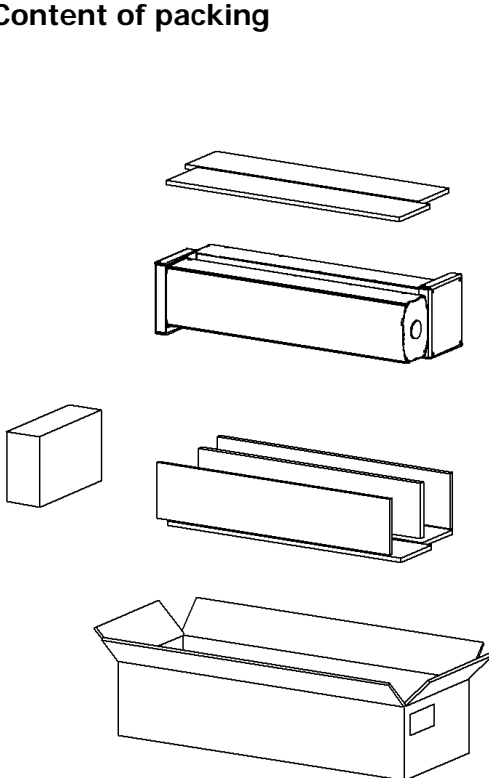

Packing details, 3-column frame

STANDARD 2-COLUMN COLLI'S +

Box Packing

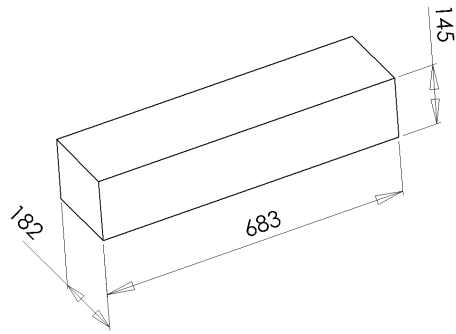

Weight 14 kg

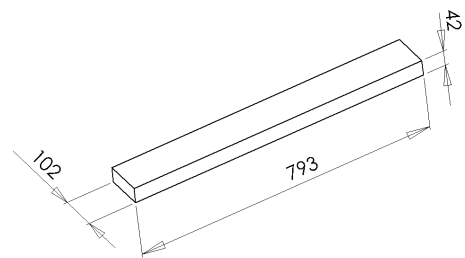

Weight 7 kg



Content of packing

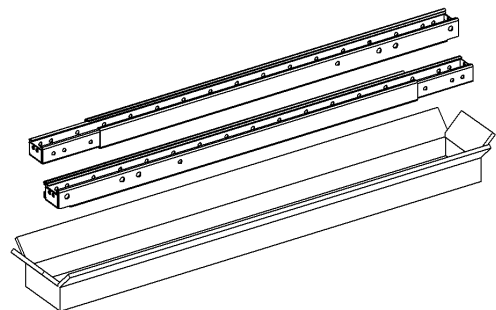
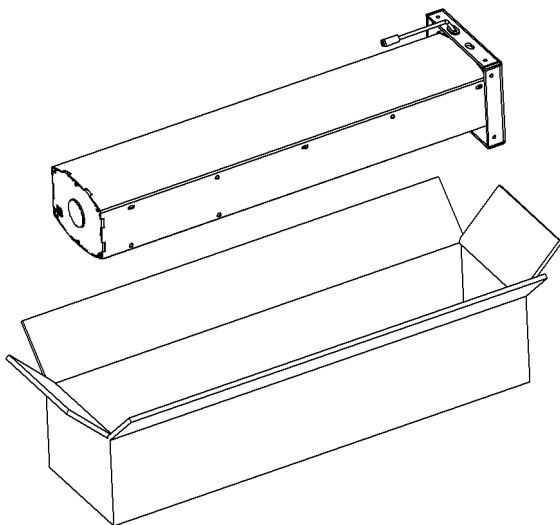

Main measures and specifications, 2-column frame

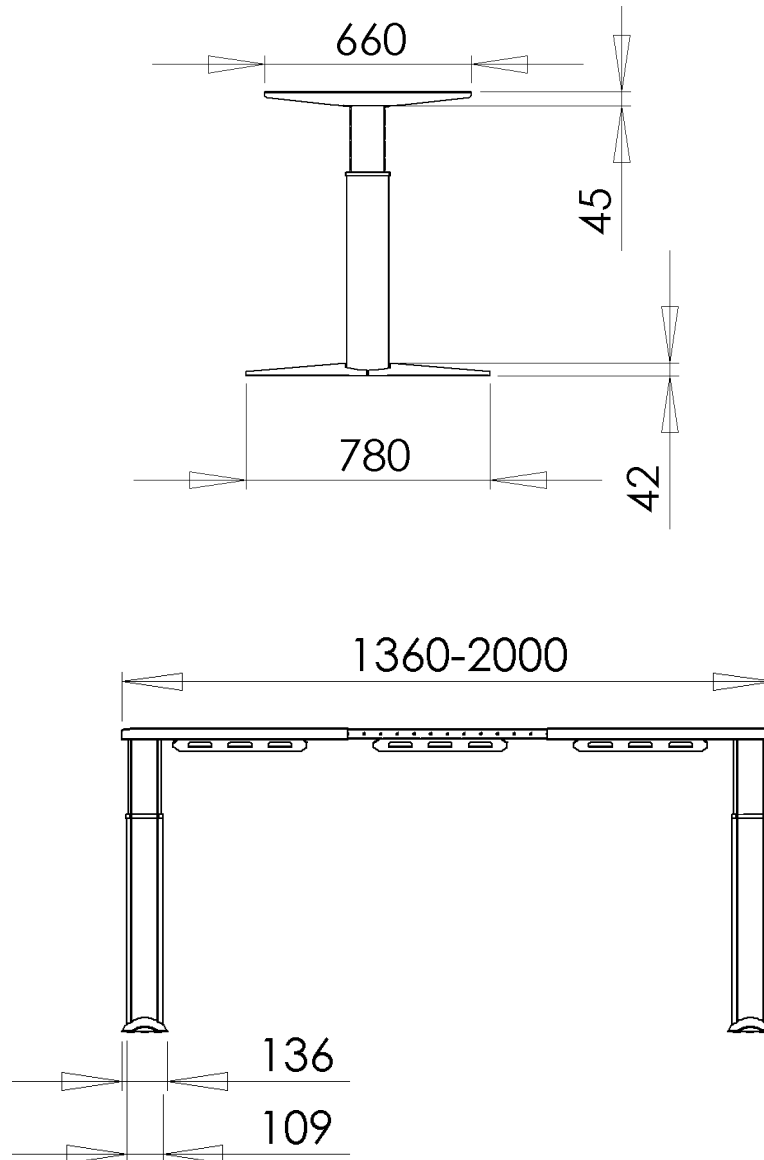

H (height), frame only	66 - 118cm
Lifting capacity, frame	200 kg
Speed	28 mm/sec
	- electronic synchronized

If further documentation needed, please find dwg documentation on the website.

Main measures and specifications, 3-column frame

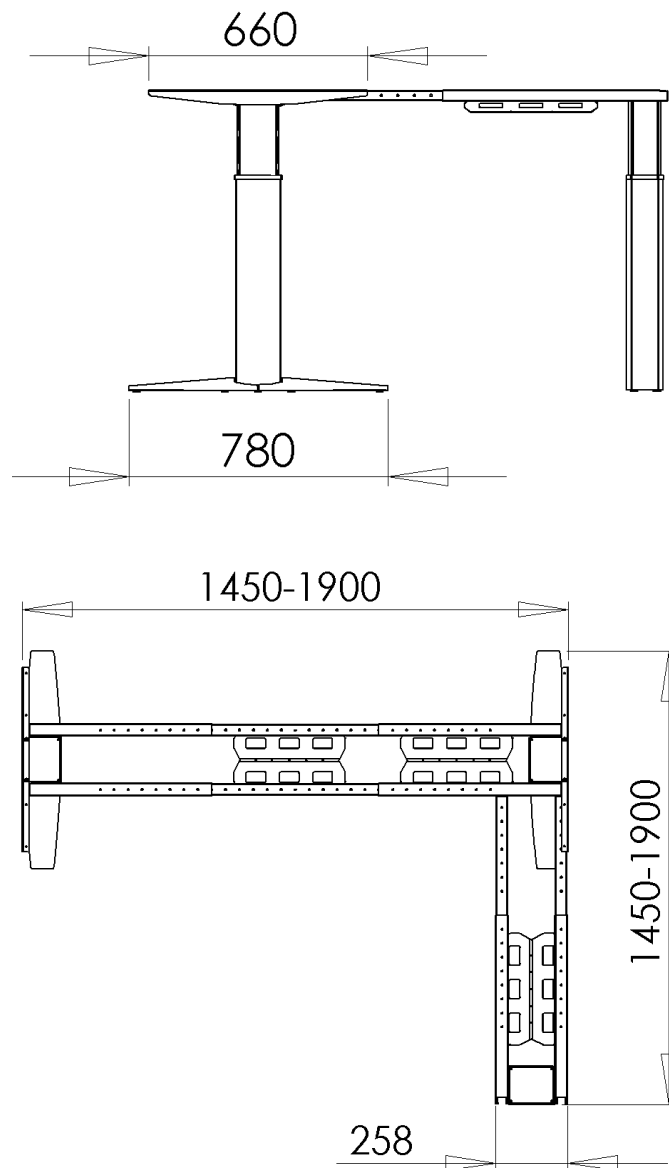

H (height), frame only	66 - 118cm
Lifting capacity, frame	300 kg
Speed	28 mm/sec
	- electronic synchronized

Tabletop drillings, 2-column frames

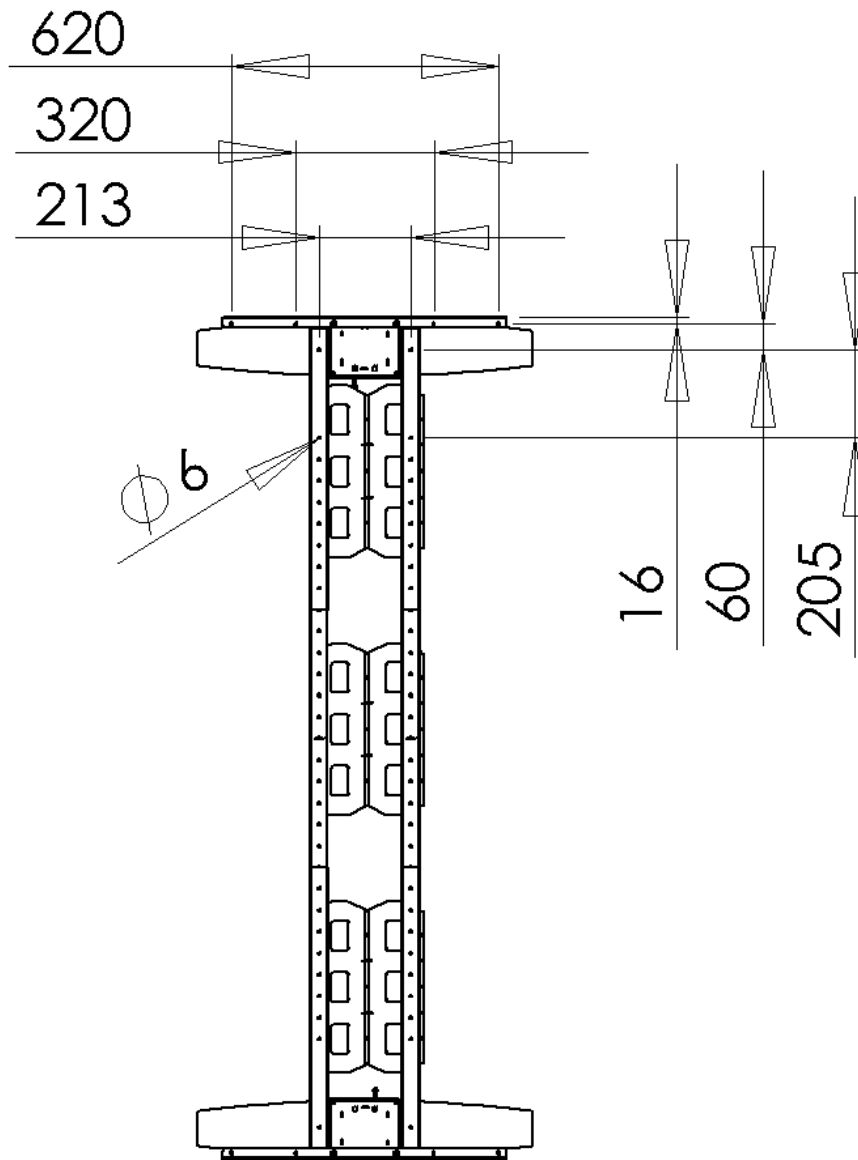

Tabletop drillings, 3-column frames

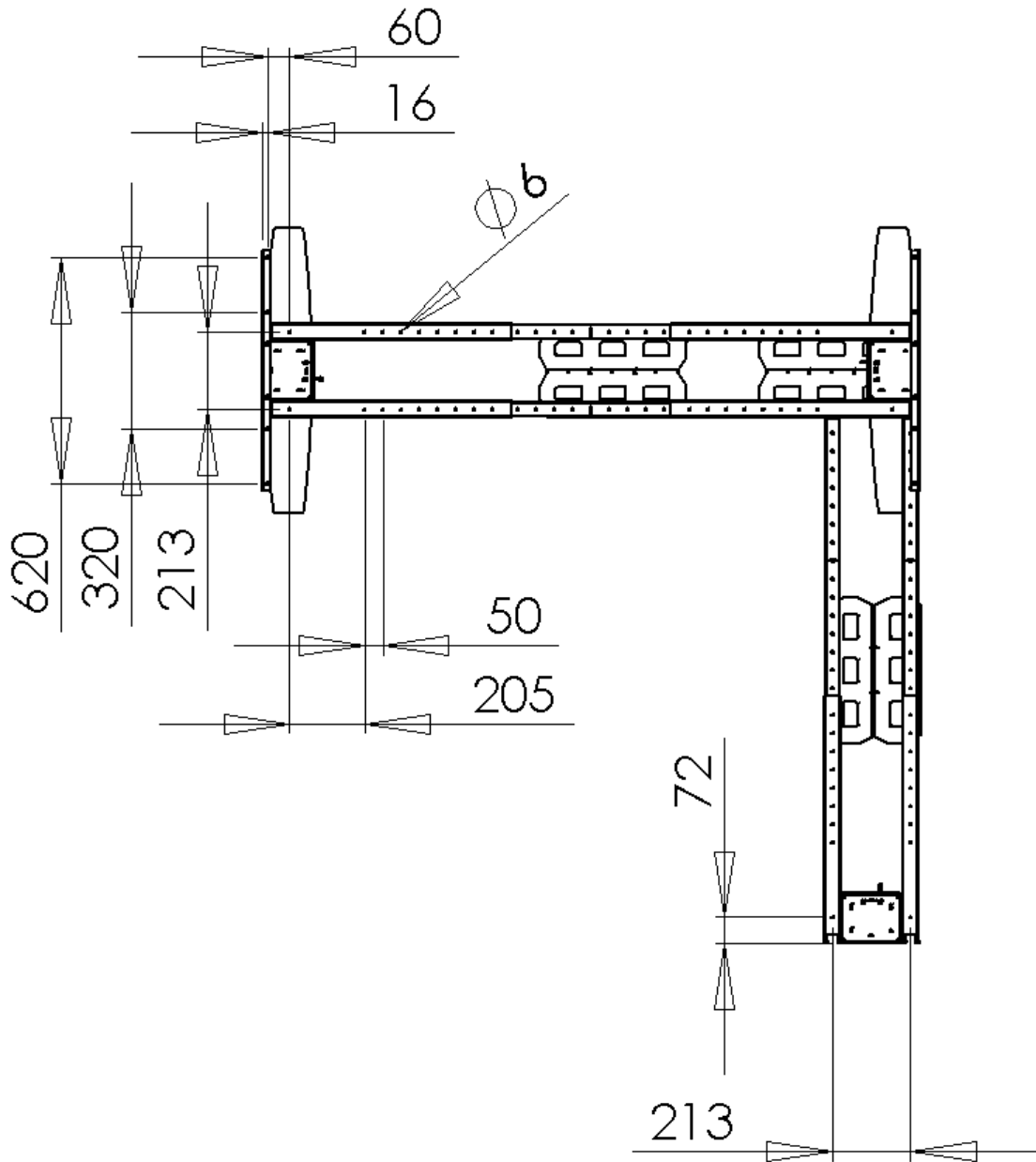

Assembly and use

Along with all products a "Direction for assembly and use" is delivered. In this you will find a detailed description of the way of assembly.



After the frame has been mounted the chosen tabletop is mounted and the operation unit will be possible to fix at the bottom side of the tabletop. This operation unit has two rocker switches.

With rocker switch A and B it is possible to move the tabletop up and down and can be stopped at all levels. For safety reasons it is necessary to push both buttons at the same time for moving the table up and down.

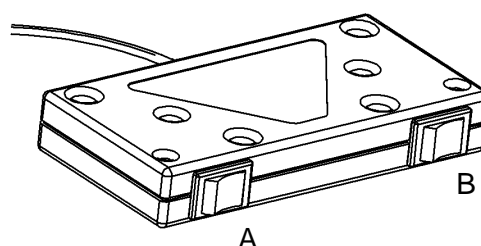

Safety and tests

All products have been tested up against the following norms:

ISO/DIS 8019

DS/ISO 7172

The norms mention above is possible to find at the website in the section “Norms and approvals”.

DECLARATION OF CONFORMITY

We hereby declare, under our sole responsibility that the following products:

- ConSet sit and stand tables product type 501-23

which are covered by this statement, are in conformity with the following standards and other normative documents::

- Counsel Directive 98/37/EF
- Counsel Directive 89/336/EØF with later changes
- Counsel Directive 73/23/EØF with later changes

With reference to the Machinery Directive (98/37/EF) please be aware:

- the sit and stand table is considered a machine and
- the sit and stand table may not be used until it has been assembled and installed according to the instructions.”.

Component specifications

Metal sheet parts:	St 37-2
Gear parts:	St 70-2
Gear motor:	CS no. 314430
Power supply:	100 W AC Power Transformer Consumption: 100 Watts; Standby: Max 0,9 Watts
Plastic components:	PA6, POM
Surface treatment	Visible metal parts powder coated in "alu" colour, RAL9006 and black, RAL 9004 Non visible metal parts are surface treated (e.g. plated)