

BROMIC[®]
HEATING



BROMIC[®]
TUNGSTEN SMART-HEAT

TUNGSTEN
SMART-HEAT™ ELECTRIC

TUNGSTEN SMART-HEAT™ ELECTRIC

Our Tungsten Smart-Heat™ Electric series offers high performance radiant heating to outdoor and semi-enclosed spaces alike, with an industrial design style. It also boasts a high-temperature coating to suit all environments. With a stainless-steel construction, its durable element will emit a soft red glow to create a warm ambience in your space.

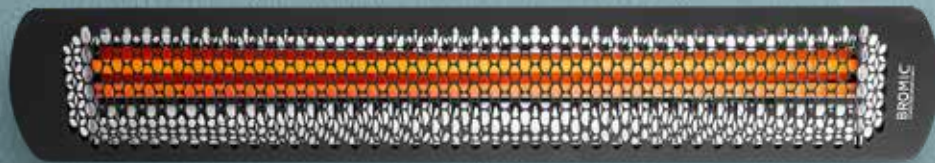

2000W / 3000W / 4000W / 6000W
BLACK

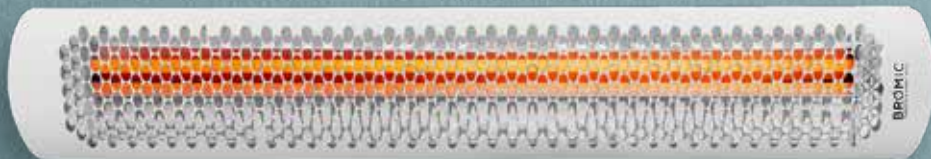

4000W & 6000W
WHITE



HIGH PERFORMANCE
Matte Finish Stainless-Steel
construction

**TOTAL MOUNTING
FLEXIBILITY**

ANGLE BRACKET
Provides precise
directional heat

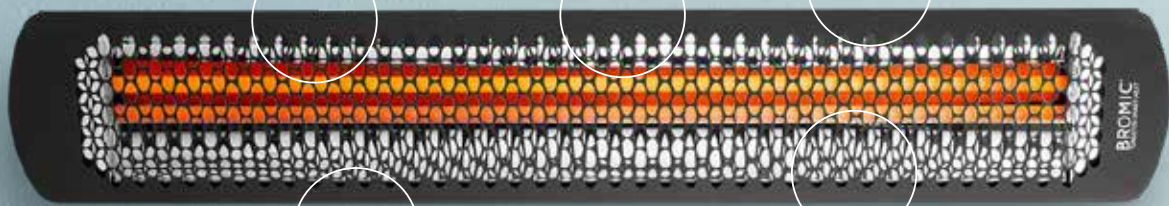

**PATENTED
PERFORMANCE**
Superior wind resistance

UNIQUE DESIGN
Honeycomb fascia facilitates
precise heat distribution





EXTEND YOUR COMFORT OUTDOORS
WITH THE SUPERIOR HEAT AND
AWARD-WINNING DESIGN OF OUR
SMART-HEAT™ OUTDOOR HEATERS.



TUNGSTEN SMART-HEAT™ ELECTRIC

MODEL NUMBER	2000 SERIES	3000 SERIES	4000 SERIES	6000 SERIES
PRODUCT CODE	BH0420030	BH0420031	BH0420032 BH0420012	BH0420033 BH0420013
FUEL TYPE	ELECTRIC	ELECTRIC	ELECTRIC	ELECTRIC
COLOUR	BLACK	BLACK	BLACK WHITE	BLACK WHITE
HEAT AREA	65FT	100FT	130FT	160FT
RATED CURRENT **	240V/8.3A 208V/9.62A 277V/7.22A	240V/12.5A 208V/14.42A 277V/10.83A	240V/16.6A 208V/19.23A 277V/14.44A	240V/25A 208V/28.85A 277V/21.66A
MINIMUM FLOOR CLEARANCE	WALL 72" CEILING 96"		WALL 72" CEILING 96"	

MOUNTING OPTIONS

CEILING MOUNT	✓	✓	✓	✓
CEILING RECESS KIT PRODUCT CODES	BH8180010	BH8180011	BH8180010	BH8180011
WALL MOUNT	✓	✓	✓	✓
RECESSED FLUSH MOUNT	✓	✓	✓	✓
CEILING POLE MOUNT	✓	✓	✓	✓
TUBE SUSPENSION KIT (36") PRODUCT CODE	BH8180012			
FREESTANDING	-	-	-	-

CONTROL OPTIONS

ON OFF	✓	✓	✓	✓
ON OFF PRODUCT CODE	BH3130010-1			
DIMMER	✓	✓	✓	✓
DIMMER PRODUCT CODE	BH3130011-1			
MASTER REMOTE *	✓	✓	✓	✓

Measurements displayed within this document are minimum requirements for installation. Bromic takes no responsibility for incorrect or non-compliant installations. All measurement in this document are displayed in inches.

** Available in varying voltages: 240V, 208V and 277V

* Control up to six zones of heaters with unlimited heaters per zone from a single control. Works with dimming and on/off controllers. Control operates within 100ft of heaters.

PRODUCT MEASUREMENTS

2000W & 4000W

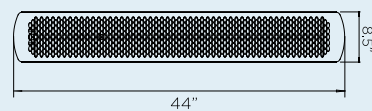

3000W & 6000W

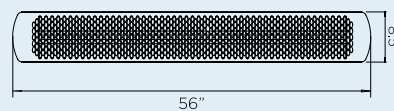

CEILING RECESS

CEILING RECESS FRAME 2000W & 4000W

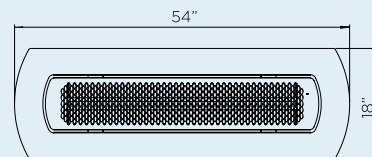

CEILING RECESS FRAME 3000W & 6000W

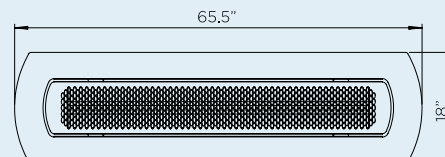

CEILING RECESS

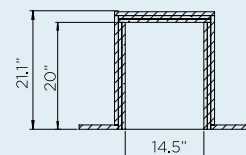

MINIMUM
CEILING CAVITY

2000W & 4000W

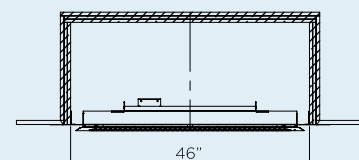

3000W & 6000W

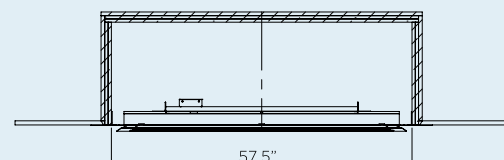

CEILING & WALL MOUNT CLEARANCE

CEILING MOUNT CLEARANCE

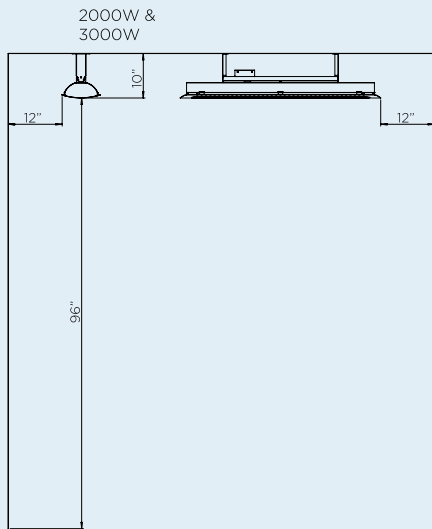

CEILING MOUNT CLEARANCE

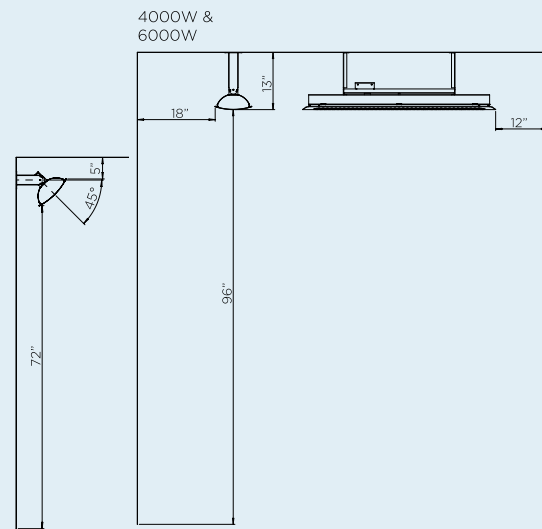

CEILING POLE CLEARANCE

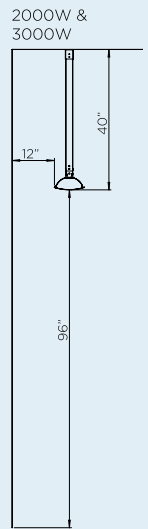
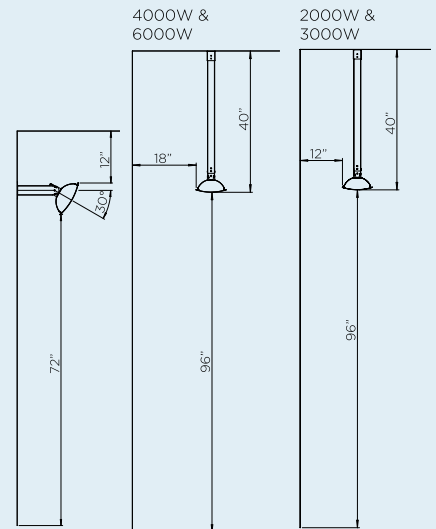

WALL BRACKET (INCLUDED)

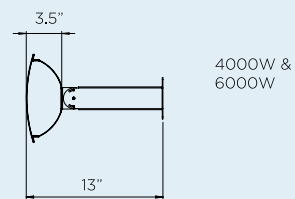
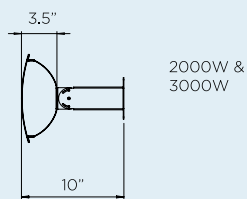

HEAT AREA

2000W SERIES

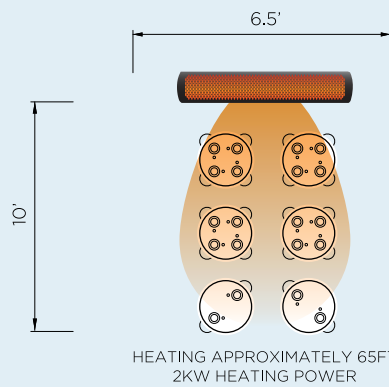

3000W SERIES

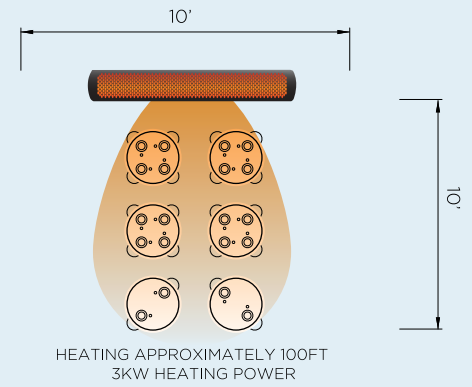

4000W SERIES

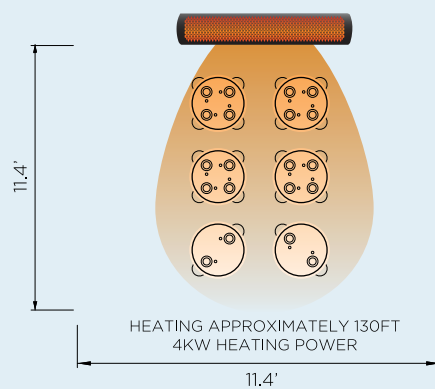

6000W SERIES

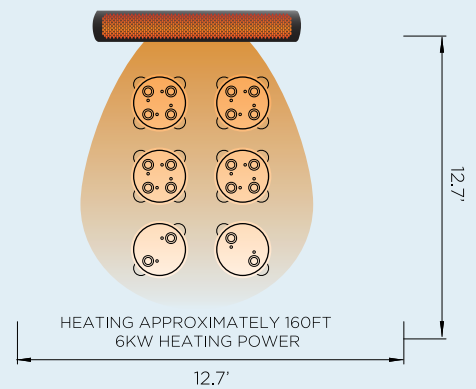

EXPLORE THE POSSIBILITIES

With the Bromic Smart-Heat™ complimentary design service, designing a solution to optimize heating for your outdoor spaces is simple.

Learn more...
bromic.com/designservice

[BROMIC.COM/HEAT](https://bromic.com/HEAT)

ASIA PACIFIC | NORTH AMERICA | EUROPE

Bromic pursues a policy of continuing improvement in design and performance of its products.
The right is therefore reserved to vary specifications without notice.

07.08.2020