

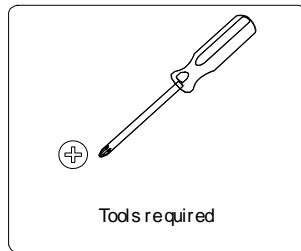

WCC 2442

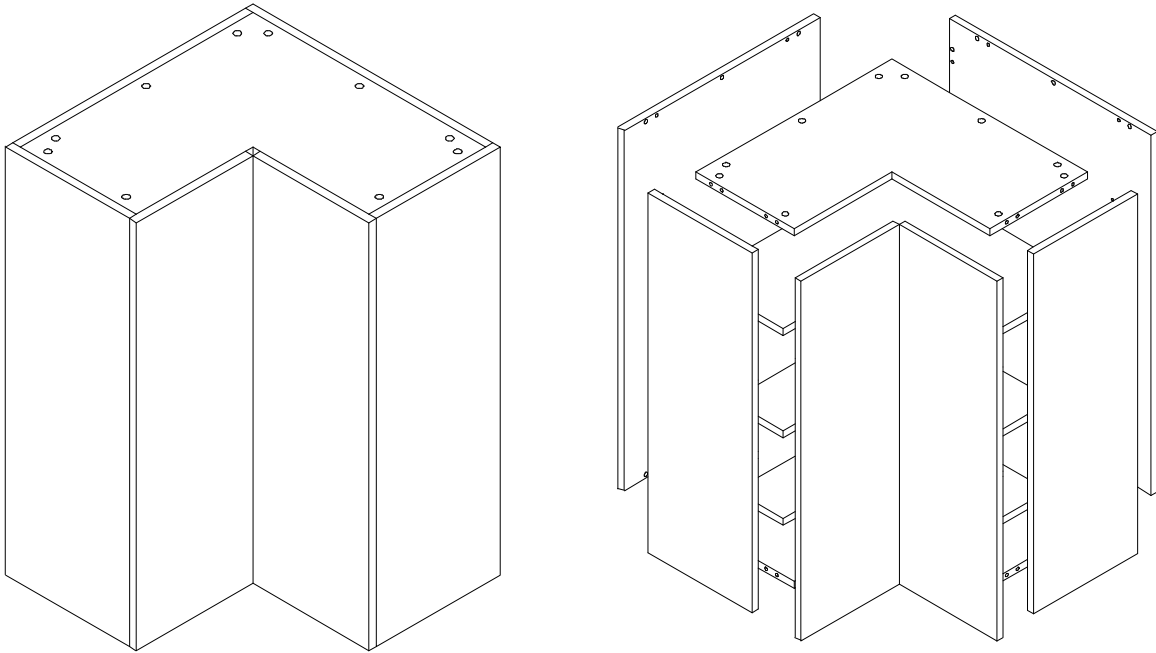

Assembly instructions

- Carefully read the instructions before starting the installation.
- During assembly, please follow all generally accepted safety procedures.
- Check that all appropriate and required plumbing and electrical connections exist.

If you are missing any part, please stop and contact us immediately at 1-800-222-4638 opt.5

CABINETS TO GO!
1-800-CABINET

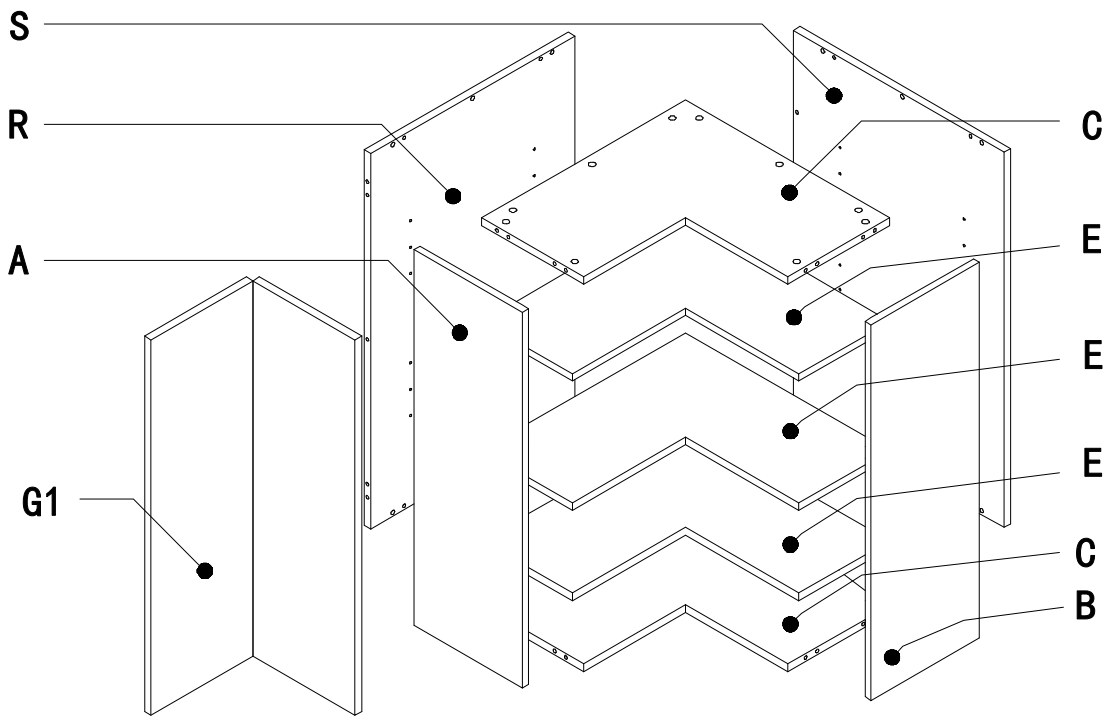
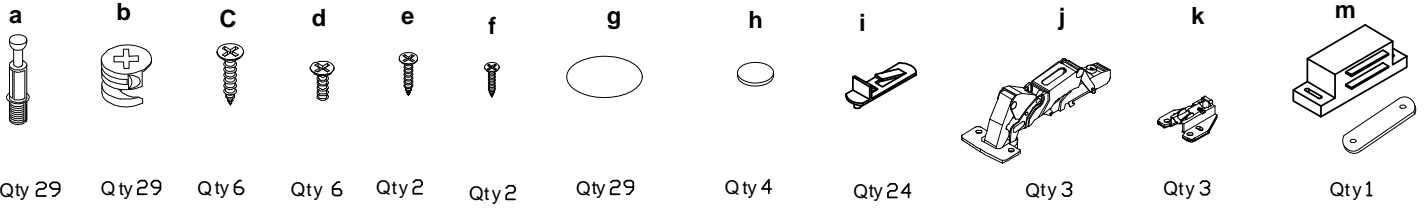

NO.	Item
B	Front Side Panel (right)
A	Front Side Panel (left)
S	Back Side Panel (right)
R	Back Side Panel (left)
C	Bottom panel
E	shelf
G1	door
C	Top panel



Soft Surface

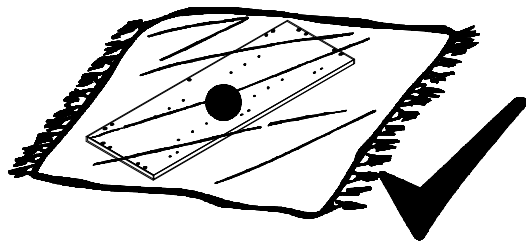

Hard Surface



1

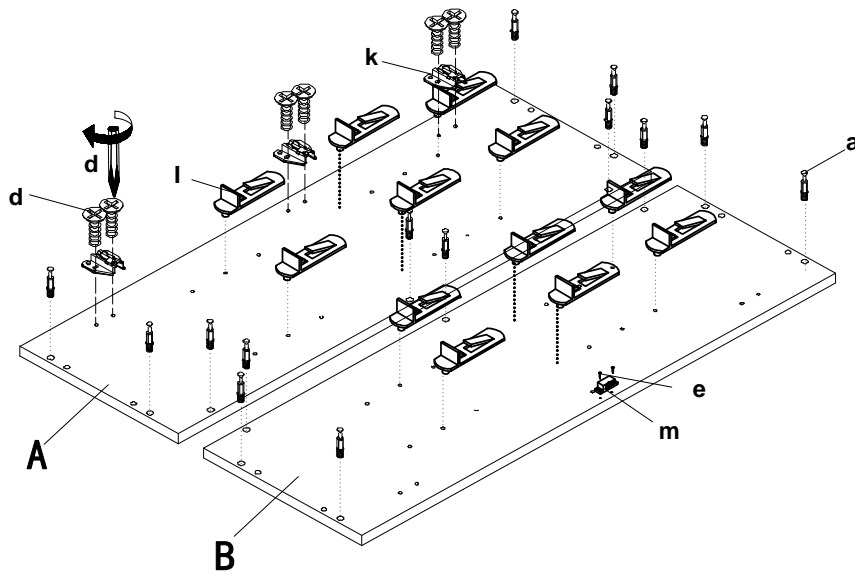
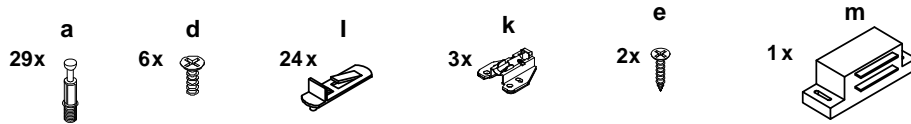

2

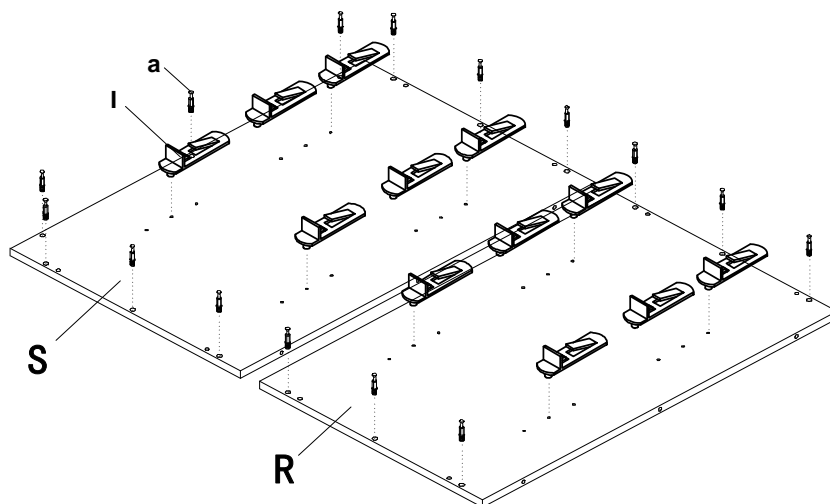

29x 

29x 

3

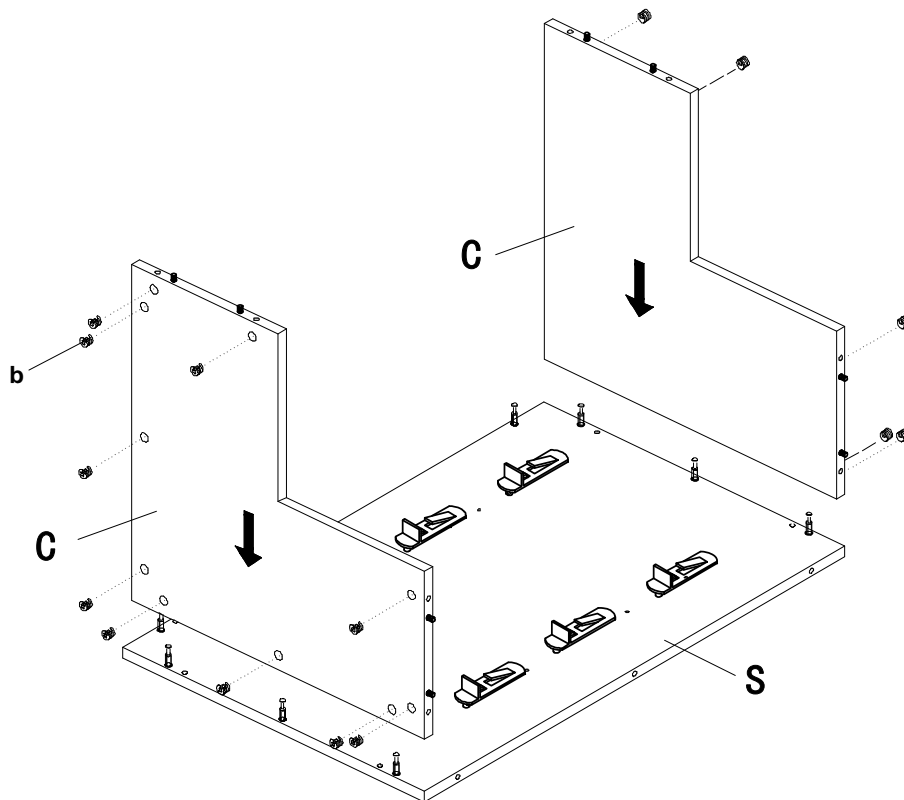

4

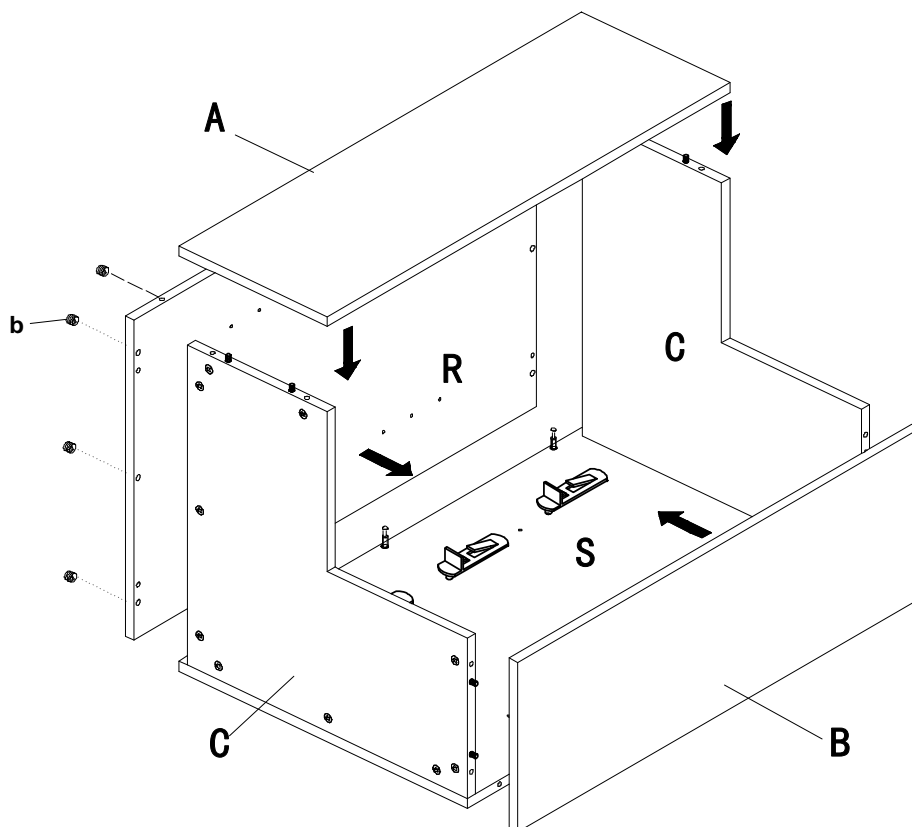

5

4x h

2x f

1x m

3x j

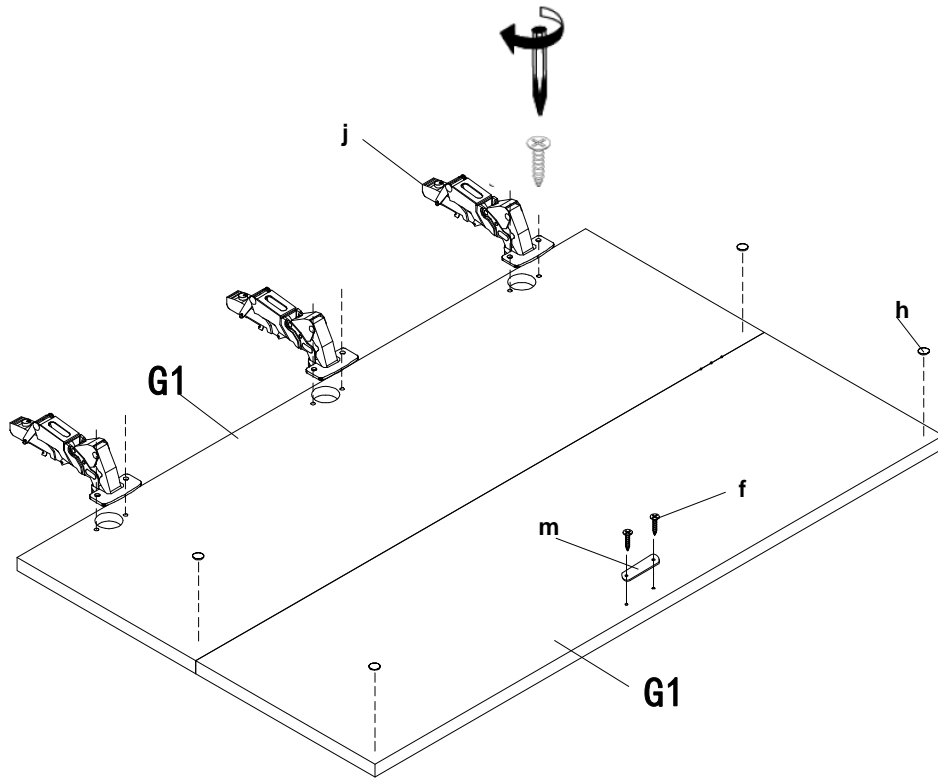

6

2x E

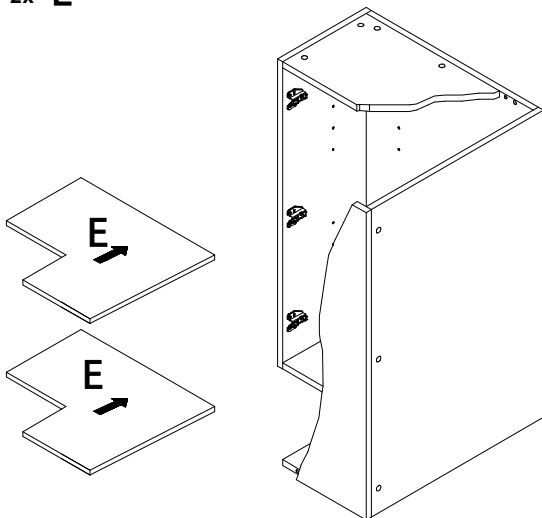

7

2x G1

