

ASSEMBLY INSTRUCTIONS

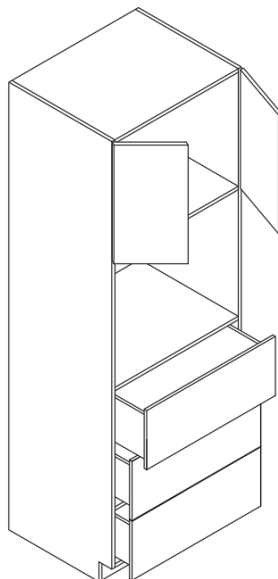

These assembly instructions are only applicable for all Pantry Cabinets

ITEM No.:OC3384SD



ATTENTION: For questions or concerns about your cabinets, assembly or installation, please contact our dedicated Customer Care Team at **1-800-CABINET (222-4638)**. Our Customer Care associates are here for you every step of the way.

► General Instructions:

Thank you for purchasing a Cabinets To Go product. You are now the proud owner of a high quality product designed to face the test of daily use and guaranteeing your enjoyment for many years to come.

Carefully read the instructions before starting the installation.

During assembly, please follow all generally accepted safety procedures.

Failure to adhere to the following instructions will invalidate the warranty and Cabinets To Go will decline any responsibility for any damages caused. Any installation which does not correspond to the instructions may result in defects, malfunctioning parts, significant damage and/or injury.

Before the assembly begins, check that all appropriate and required plumbing and electrical connections exist.

Before drilling, make absolutely sure that there are no pipes (gas, water, electricity, heating, etc.) at the drilling location. Cabinets To Go will not be held responsible for failure to follow these instructions.

PRIOR TO ASSEMBLY, PLEASE MAKE SURE YOU HAVE ONE FACE FRAME BOX AND ONE CARCASS BOX, WHICH HAVE ALL THE PARTS IN THE QUANTITIES MENTIONED BELOW. IF YOU ARE MISSING ANY PARTS, PLEASE STOP AND CONTACT CUSTOMER CARE IMMEDIATELY AT 1-800-CABINET.





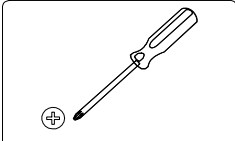
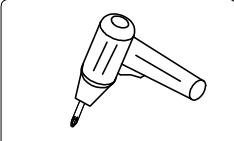
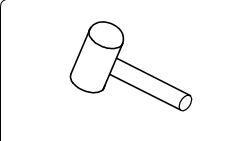

► Items Quantity

Item	Description	Qty
A	Doors	2
B	Back Panel	1
C	Side Panels Left & Right	2
D	Top, Bottom, & Center Panels	4
E	Drawer Fronts	3
F	Toe Kick	1
G	Drawer Box	3
H	Braces	2
I	Hardware Box	
Hinges 4pcs, Bumpers 16pcs, 2/3" Flat Head Screws 8pcs, 2/3" Round Head Coarse Thread Screws 16pcs, Cam Locks Male & Female 42pcs, Wooden Dowels 28pcs, Drawer Glides 3pc		

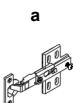
► Required tools:

		
Tools Required: Phillips Screwdriver	Optional Tools: Electric Drill	Optional Tools: Rubber Mallet

► Hardware Box:

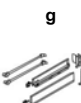
						
Qty 4	Qty 16	Qty 8	Qty 16	Qty 42	Qty 28	Qty 3

The materials listing above are for the largest unit in this instruction set. Smaller units may require less hardware and materials; therefore, your item may contain a smaller number of each.

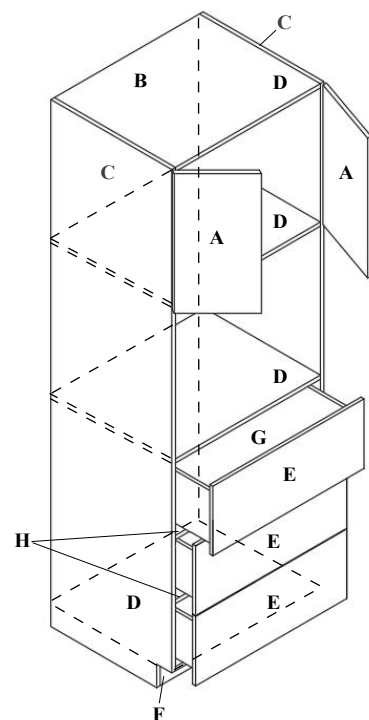

► **Instructions:**

1. Unpack box & identify pieces on Page 2. Place side panel (C) onto a soft work surface. (Figure 1)

2. Install Hinge base plates (a) & drawer glides (g) onto side panel into designated holes using screws (d). (Figure 2)

3. Install metal male cam locks (e) into designated holes on side panel (C), braces (H), and top/center/bottom panels (D). Use screwdriver to tighten. Install the wooden dowels (f) into designated holes. (Figure 3)

4. Install the toe kick (F) onto bottom panel (D). (Figure 3)

5. Install Top/Center/Bottom Panels (D) onto the right side panel (C). (Figure 3)

6. Install locking lugs (e) into designated holes, and then lock them with a screwdriver. (Figure 4)

7. Install side panel (C) onto the assembled panels using the same methods above. (Figure 5)

8. Assemble the drawer boxes. (Figure 6)

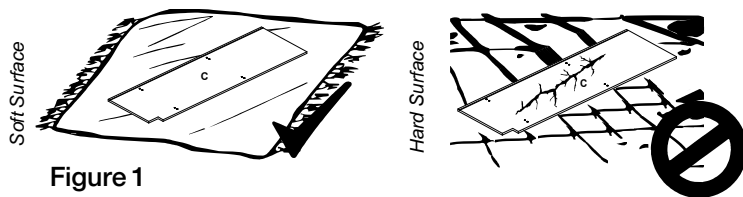

Figure 1

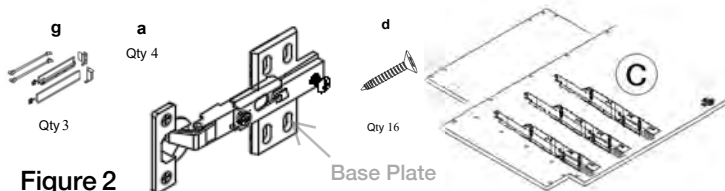

Figure 2

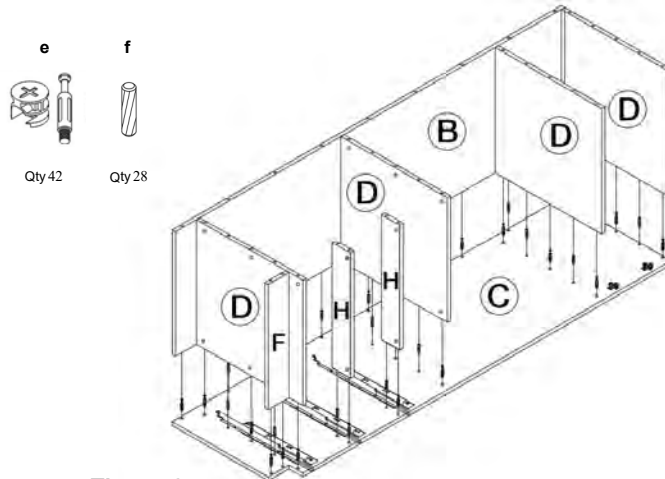

Figure 3

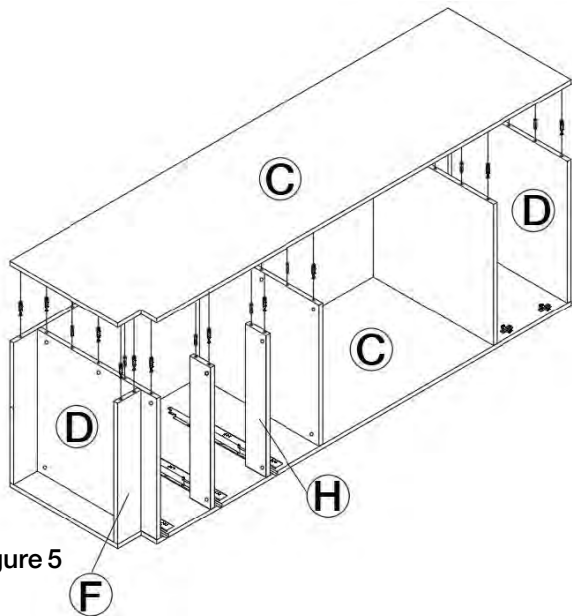

Figure 5

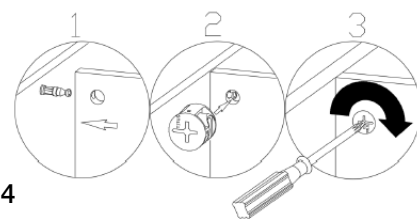

Figure 4

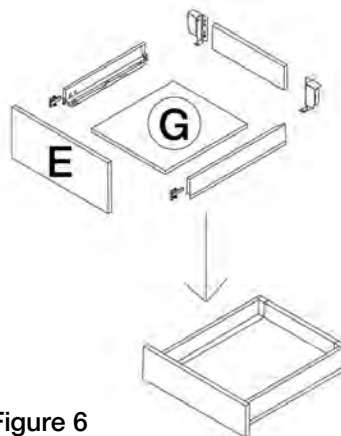

Figure 6

9. Install hinges onto doors into designated holes using screws provided.

Install doors onto cabinet sides through pre-marked screw holes.

Install the bumpers (b) onto the door corners opposite of the hinges.

Install the assembled drawer boxes into the drawer glides.

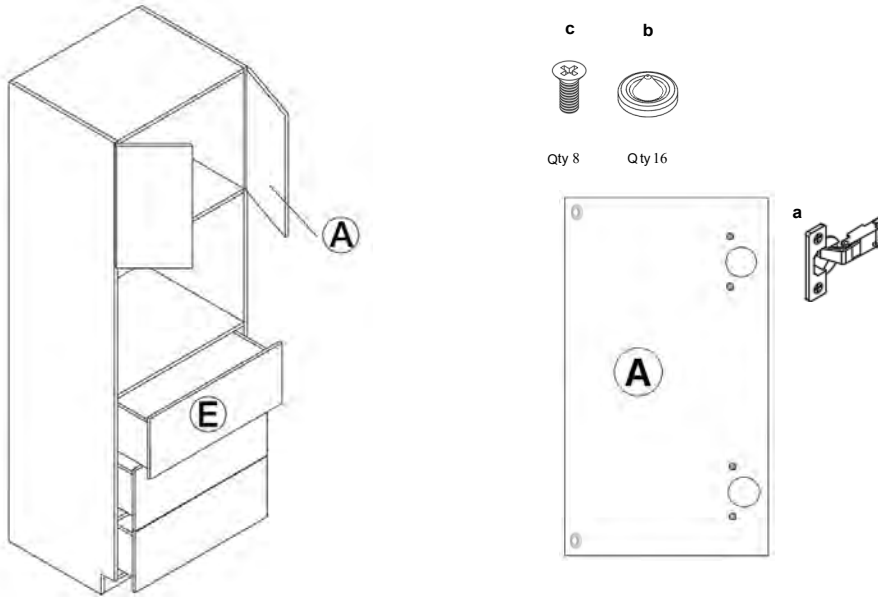

► **Maintenance**

For daily cleaning, use a dry cloth and a soft liquid cleaner.

Never use abrasive cleaners containing acetone, chlorine or strong bleach. Also, do not use tools as scrapers, metallic brushes, and other products which can scratch or tarnish surfaces.

Under no circumstances should you use chrome cleaner on chrome-plated or brass trim, hinges, handles, sockets etc.

Good ventilation is essential for maintaining the quality and look of this furniture.

Warranty and Customer Care Information

For the most up to date warranty information for your product, please visit our website - www.cabinetstogo.com to get the specific details. If you have any questions with warranties or to make a claim, please contact Customer Care by email - customer care@cabinetstogo.com or call 1-800-CABINET.