

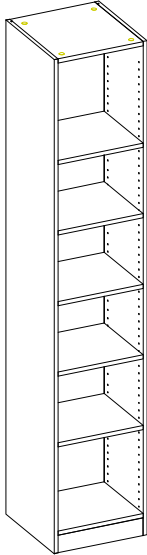

## Gracious Home 15"W 15"D 5 Shelf Closet

### ASSEMBLY INSTRUCTIONS



These assembly instructions are only applicable for the 15"W 15"D 5 shelf closet.

**General Instructions:**

Thank you for purchasing a Gracious Home product. You are now the proud owner of a high quality product designed to face the test of daily use and guaranteeing your enjoyment for many years to come.

Carefully read the instructions before starting the installation.

During assembly, please follow all generally accepted safety procedures.

Failure to adhere to the following instructions will invalidate the manufacturer warranty. The manufacturer will decline any responsibility for any damages caused. Any installation which does not correspond to the instructions may result in defects, malfunctioning parts, significant damage and/or injury.

If you are missing any parts, please contact Customer Care department immediately .

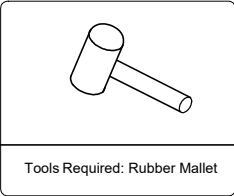
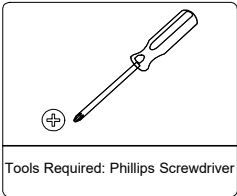











**Important:**  
**Weight Capacity** - Overall Unit 100 lbs.  
Each shelf has a maximum capacity of 30 lbs.

**⚠ WARNING!**

**Children have died from furniture tip over. To reduce the risk of furniture tip over:**  
ALWAYS install anti-tipping hardware that is provided.  
NEVER allow children to stand, climb or hang on drawers, doors, or shelves.  
NEVER overload shelves or drawers - evenly distribute the weight.

Hardware Bag

<b>a</b>	<b>b</b>	<b>c</b>	<b>d</b>	<b>e</b>	<b>f</b>	<b>g</b>	<b>h</b>	<b>i</b>	<b>j</b>	<b>k</b>
										
Qty 16	Qty 16	Qty 20	Qty 20	Qty 16	Qty 16	Qty 236	Qty 1	Qty 4	Qty 1	Qty 4

Cabinet Parts Detail

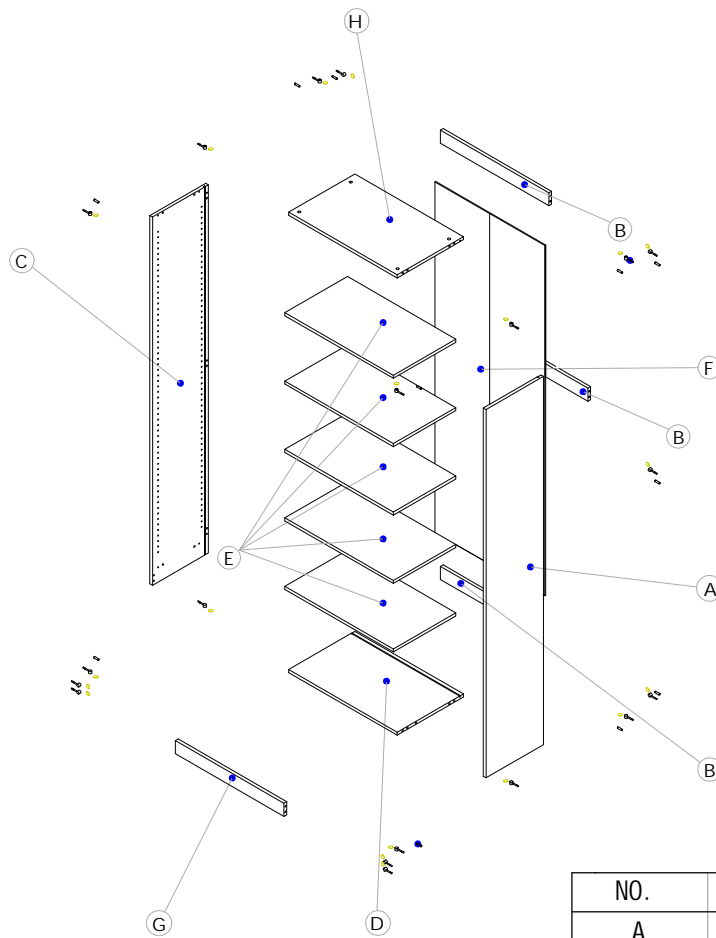

NO.	ITEM	QTY
A	Right Side Panel	1
B	Back Rail	3
C	Left Side Panel	1
D	Bottom Panel	1
E	Shelf	5
F	Back Panel	1
G	Toe Kick	1
H	Top Panel	1



Soft Surface

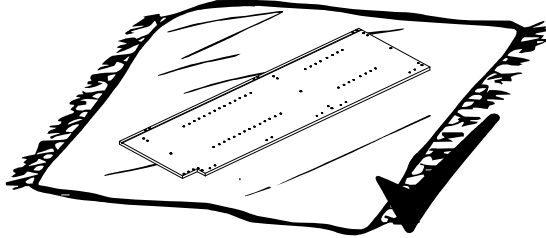

Hard surface

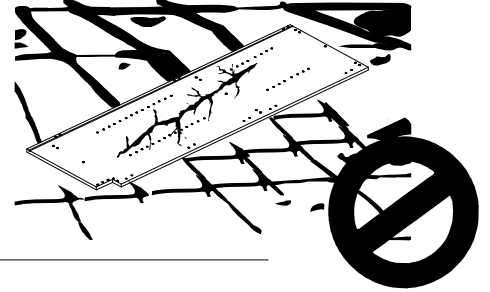

After unpacking, place the panels on a soft surface.

Screw the hardware into the side panel with an electric drill.

a



Qty 16

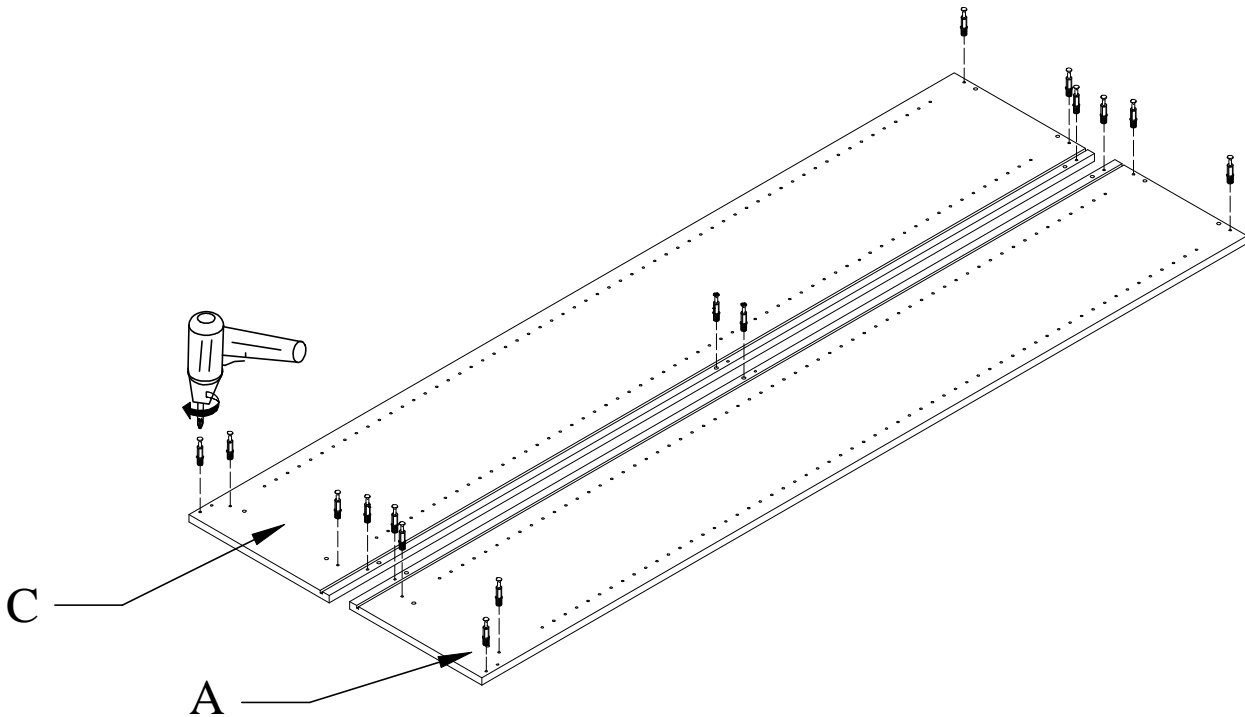

GH1515SH-WH  
GH1515SH-WN

Install the wooden dowels on the top, bottom panel, back rail and toe kick with the rubber mallet. Then connect with the right side panel. Tighten it with a screwdriver. Insert the back panel.

f



Qty 16

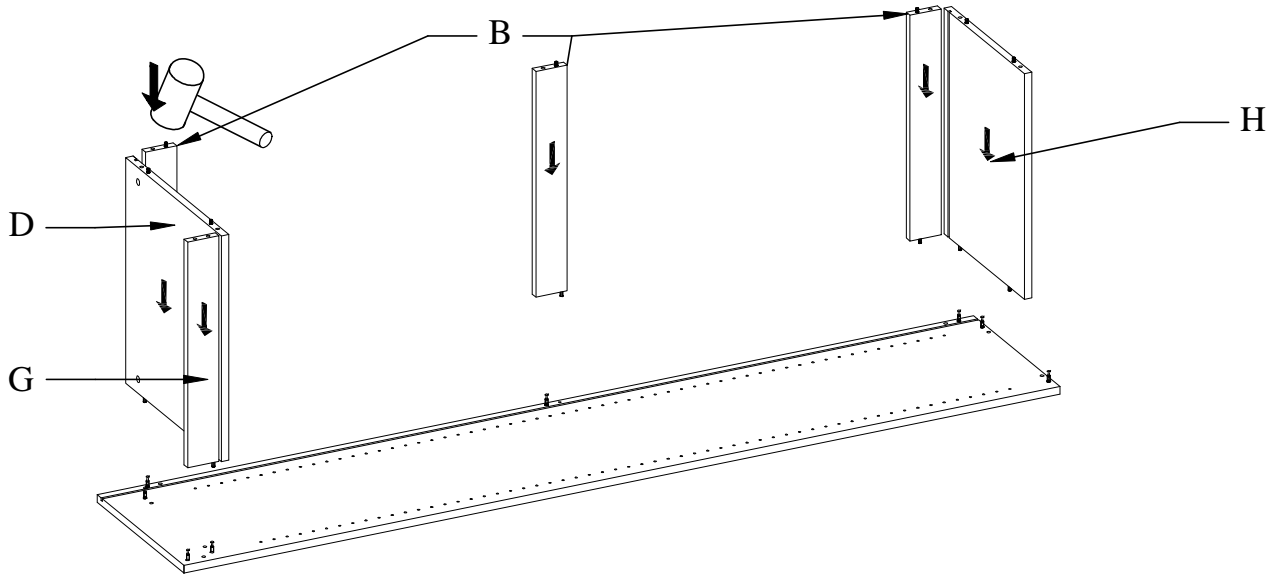

b



Qty 8

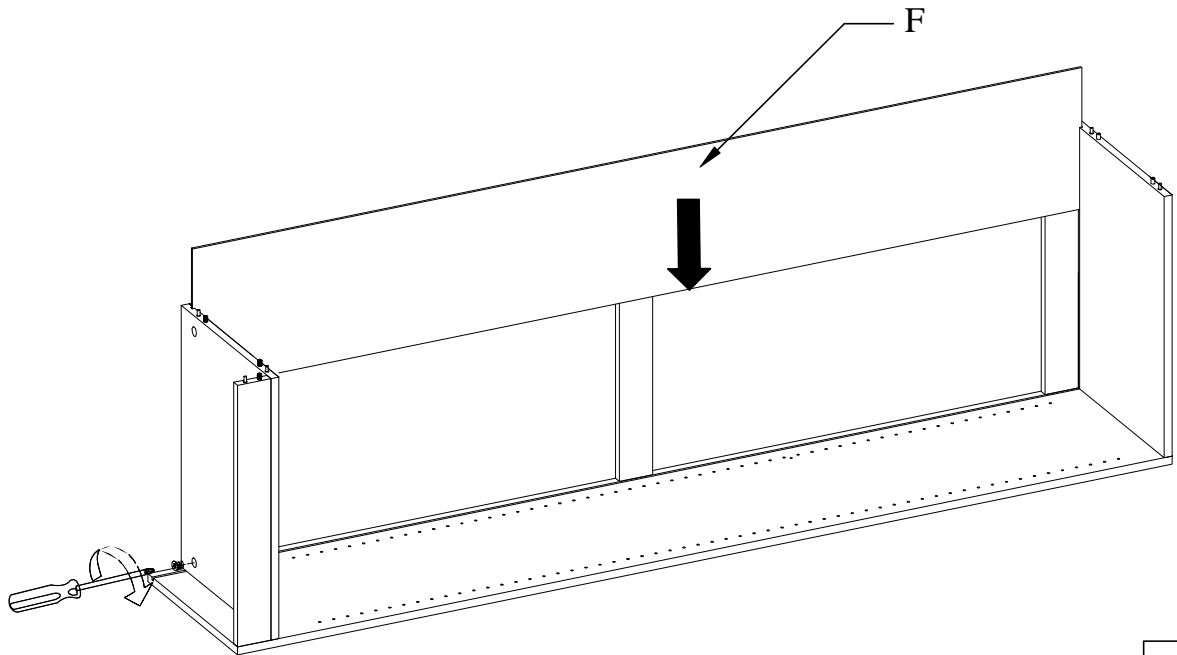

GH1515SH-WH  
GH1515SH-WN

Fasten the left side panel with a screwdriver, then paste perfect  
paste to the hole.

**b**

**e**



Qty 8

Qty 16

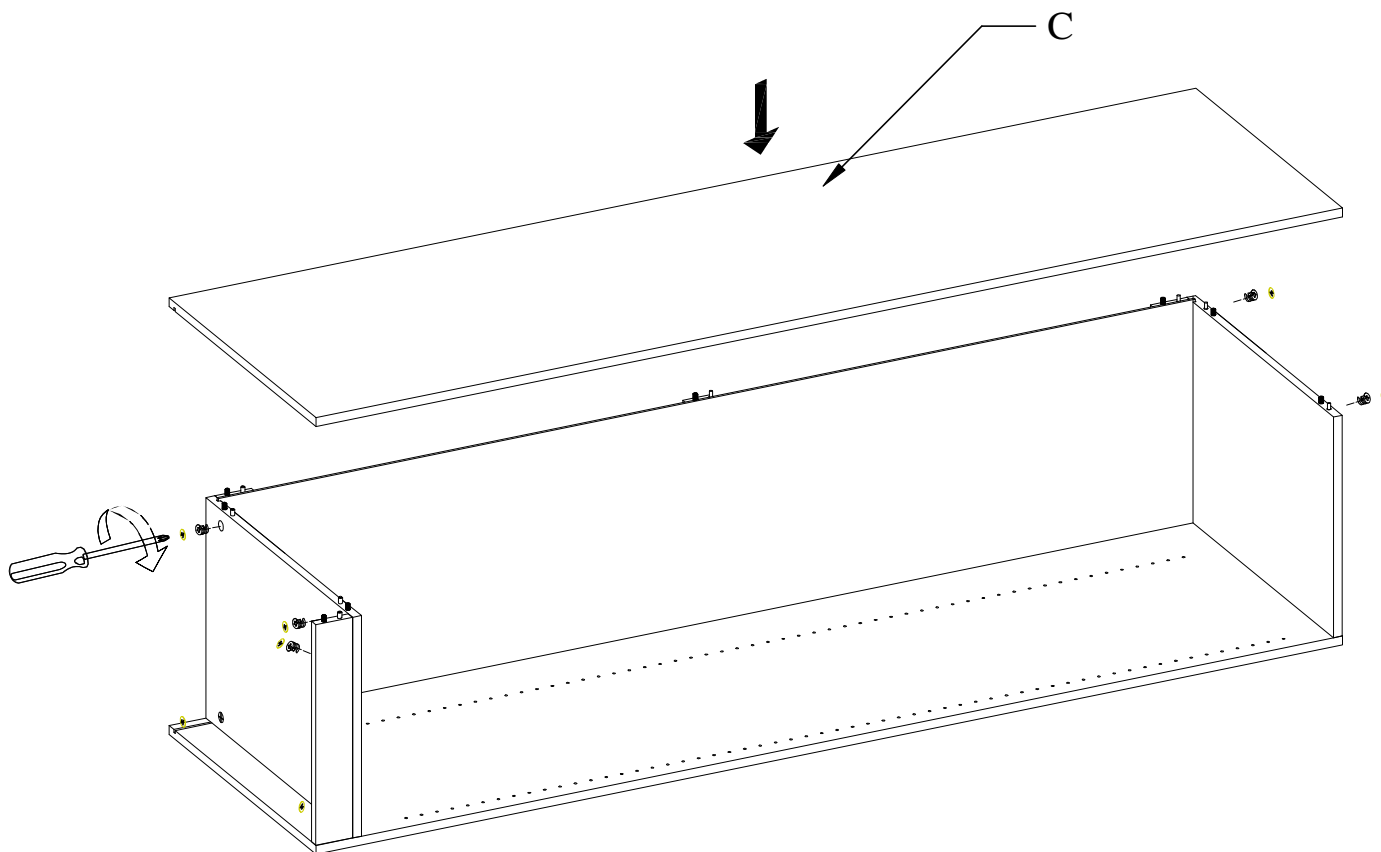

GH1515SH-WH  
GH1515SH-WN

Put the screw in to shelf hole, place the shelf, then lock it.

**C**



Qty 20

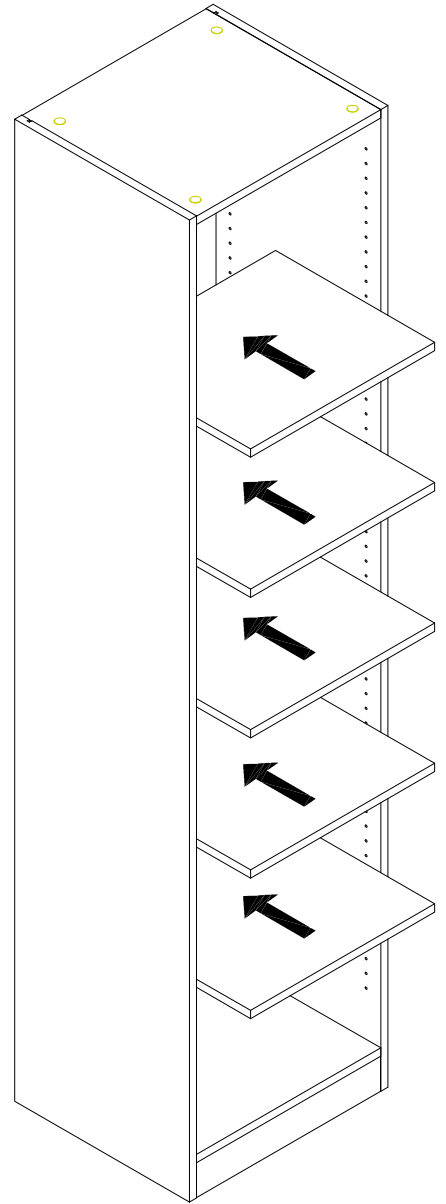
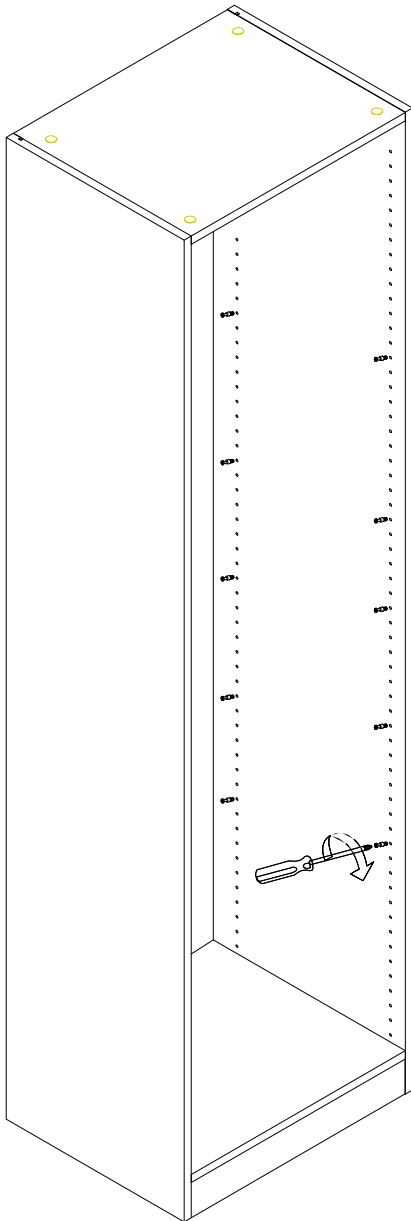

Insert the plastic plug to the rest of the shelf hole.

**g**



Qty 236

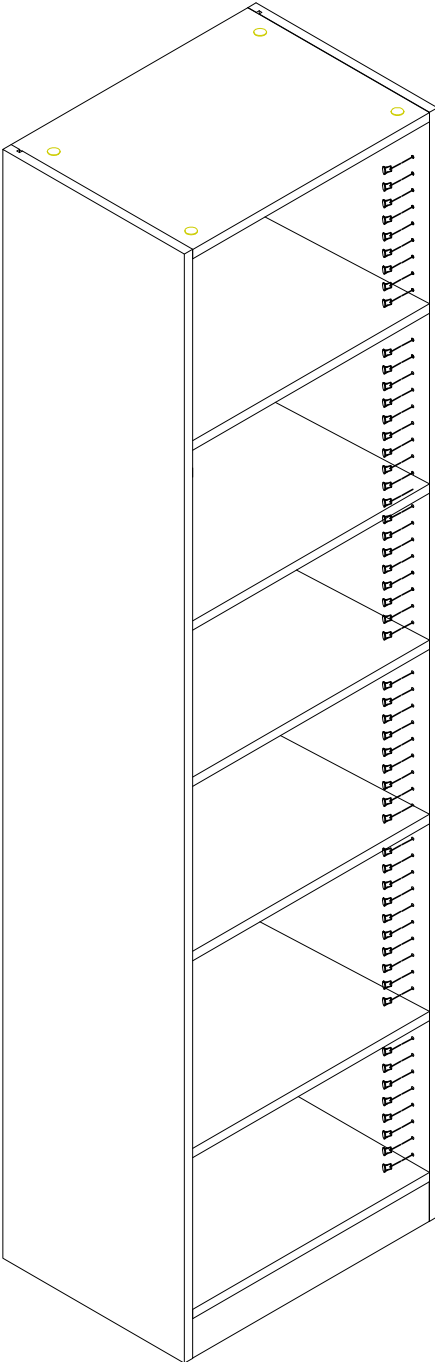

When placing two cabinets next to each other use below hardware to connect the two cabinets for extra strength.

Drill a hole in the two side panels that are next to each other then secure the closet with the screw through the hole.

**h**

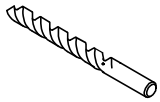

Qty 1

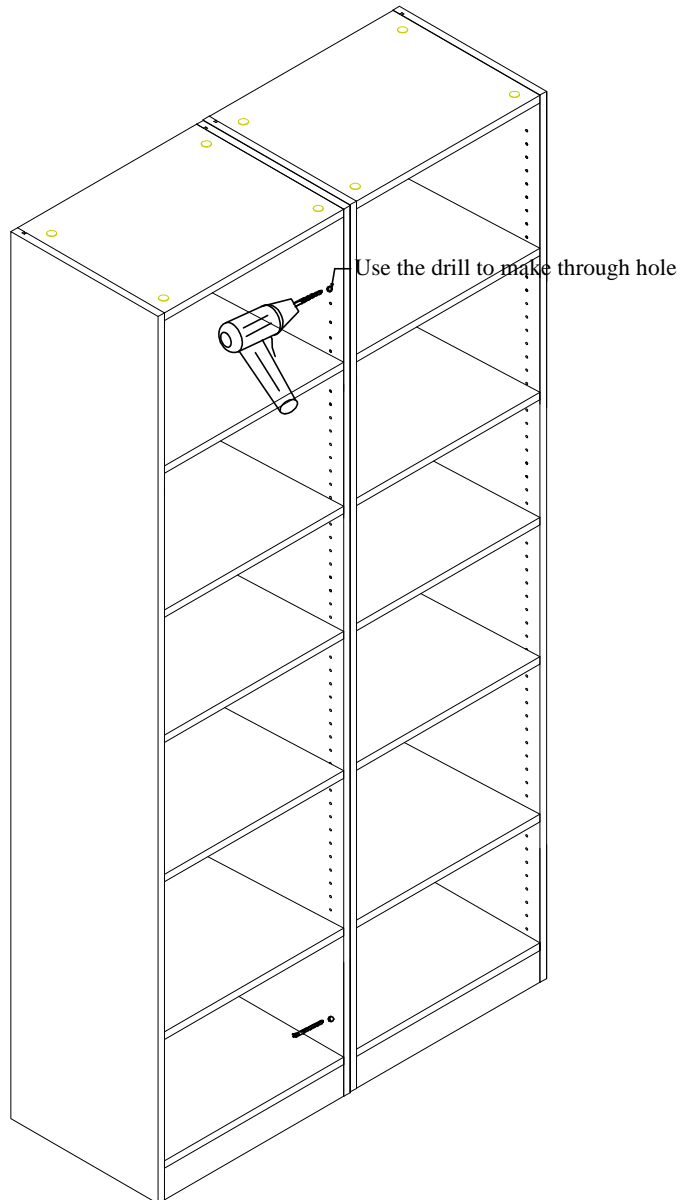



GH1515SH-WH  
GH1515SH-WN

i



Qty 4

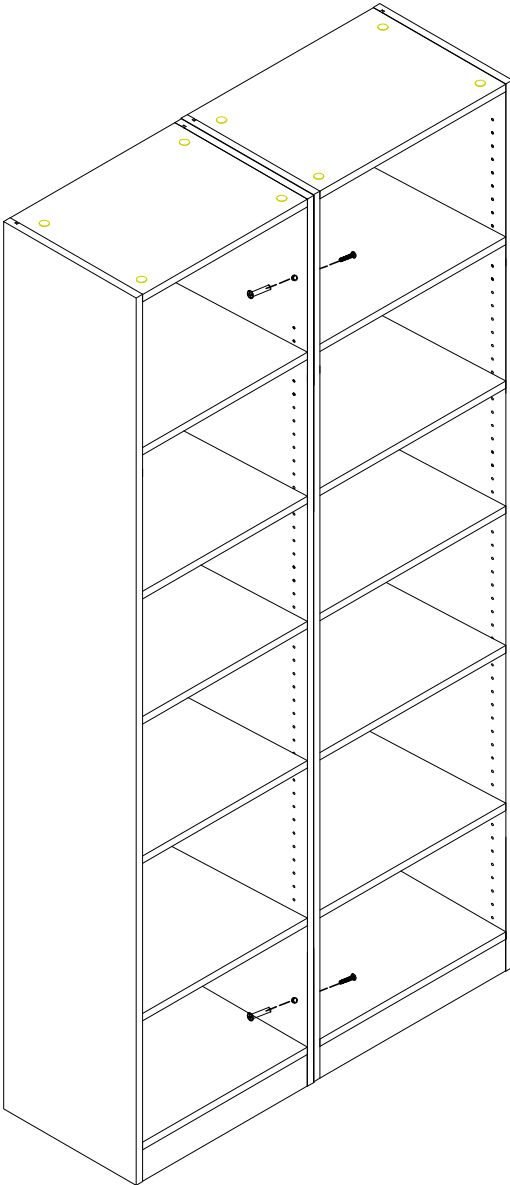

GH1515SH-WH  
GH1515SH-WN

Anti-tipping hardware kits are included to secure the closet to the wall. If there is not a stud in the wall to secure the hardware, use the wall anchor for support and attach both of the hardware to the top panel and wall evenly distributed for weight bearing.

Hardware Bag



**j**

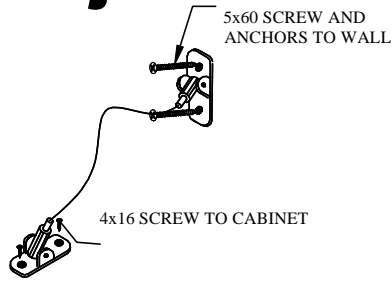

Qty 1

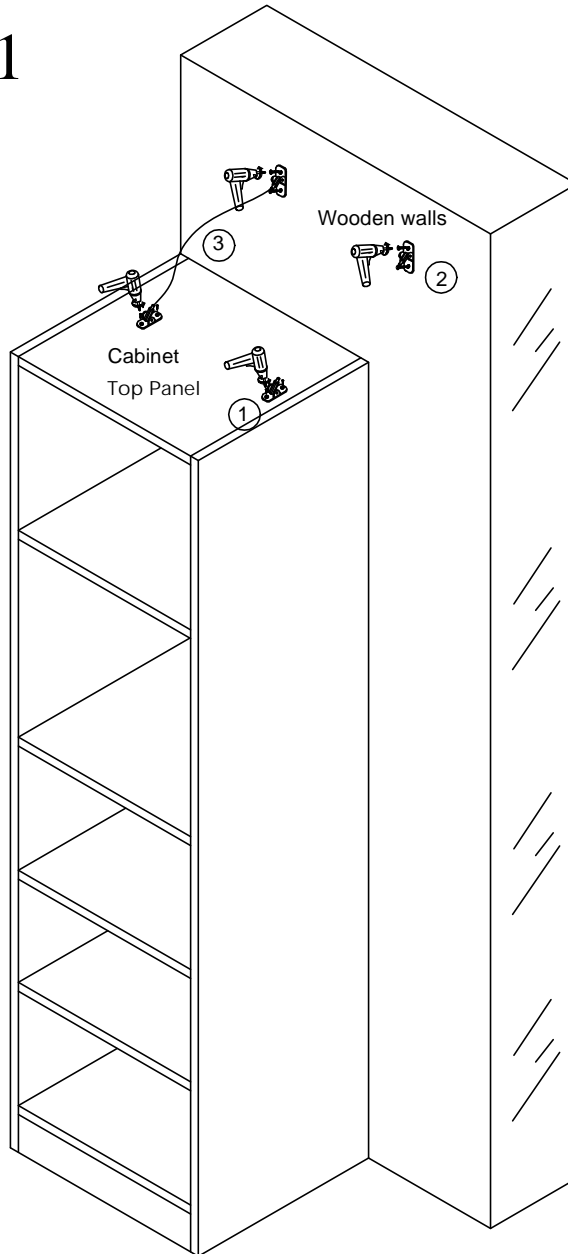

### **► Maintenance**

For daily cleaning, use a dry cloth and a soft liquid cleaner.

Never use abrasive cleaners containing acetone, chlorine or strong bleach. Also, do not use tools as scrapers, metallic brushes, and other products which can scratch or tarnish surfaces.

Under no circumstances should you use chrome cleaner on chrome-plated or brass trim, hinges, handles, sockets etc.

Good ventilation and regulating your homes temperature and relative humidity levels is essential for maintaining the quality look of your wood cabinetry.

### **25 Year Limited Warranty**

The manufacturer warrants its closets to be free from defects in material and workmanship under normal residential use, for the period of 25 years from date of purchase. This warranty is not transferable. Warping of wood, hinges, drawer glides, and mechanical parts are covered under this warranty for 25 years from the date of purchase of the closet. During this warranty period, the manufacturer will repair or replace, at our option, any closet or its component which proves to be defective in material or workmanship under normal installation, use and services. This warranty is limited to the replacement of defective parts and does not include service, labor, or transportation charges related to the removal or installation of defective parts. In addition, this warranty does not include labor or damage due to improper installation, storage, misuse or neglect. This warranty shall not apply to closets or parts that have been subject to alteration, modification, accident, abnormal use, extreme temperature, moisture levels, or abrasive/citrus cleaning chemicals. Touch up and adjustments are not included under this warranty and are the responsibility of the installer. You will be required to provide your order number, receipt, warranty certificate and pictures of the defect.

We guarantee your satisfaction with each closet. Should any closet not meet your satisfaction because of a visual defect, simply return it to your retailer, PRIOR to assembly for a replacement. We are unable to correct any visual defects after closets are assembled. Concealed damage claims (damage found after unpacking) must be made within 30 days of receipt of product.

### **Information about your warranty coverage**

This warranty does not cover damages or failure attributable to:

- Closets installed with obvious visual defects
- Defects or damage to closets caused by installation that does not comply strictly with the instructions provided.
- Issues related to the natural characteristics of wood products or the normal effects of aging
- Defects caused by product modifications completed by the owner/installer. Gluing panels, parts, or pieces is never recommended.
- Defects caused by exposure to the elements including moisture which may cause warping or splitting.
- Defects or damage to closets caused by severe accidents (e.g. fire or burns).
- Damage caused by flooding or standing water from leaking pipes, faucets, household appliances, etc: up to and including flooding and any damages caused by natural catastrophes.

### **Notes on Warranty:**

- The manufacturer shall not be liable for either its failure to perform or its delays in performance hereunder arising out of or resulting from causes beyond its control, including but not limited to, acts of God, acts of representatives, acts of government, wars, fires, floods, epidemics, quarantine, strike, freight embargoes, weather or default by suppliers due to any such causes.
- This warranty applies only to the original purchaser and installation site and is not transferable.
- This warranty is valid only for residential installation.

### **• FOR WARRANTY SERVICE**

To make a claim, contact customer care no later than 30 days following the date of receipt of product. Proof of purchase, such as the sales order receipt is mandatory when requesting warranty service.

- Product must be in original condition and properly stored in a climate controlled space once received, and up to the point of final installation. Partially assembled, fully assembled, or installed closet is considered accepted by the buyer & may not be returned or exchanged for any reason.
- The manufacturer reserves the right to designate a representative to inspect the closet for analysis.

THE SOLE REMEDY PROVIDED BY THIS WARRANTY IS THE REPAIR OR REPLACEMENT OF ANY PART OR PARTS THAT MAY PROVE DEFECTIVE UNDER NORMAL RESIDENTIAL USAGE. THIS WARRANTY DOES NOT COVER THE COST OF REMOVAL, INSTALLATION, DELAY OR TRANSPORTATION OF NEW PRODUCT.