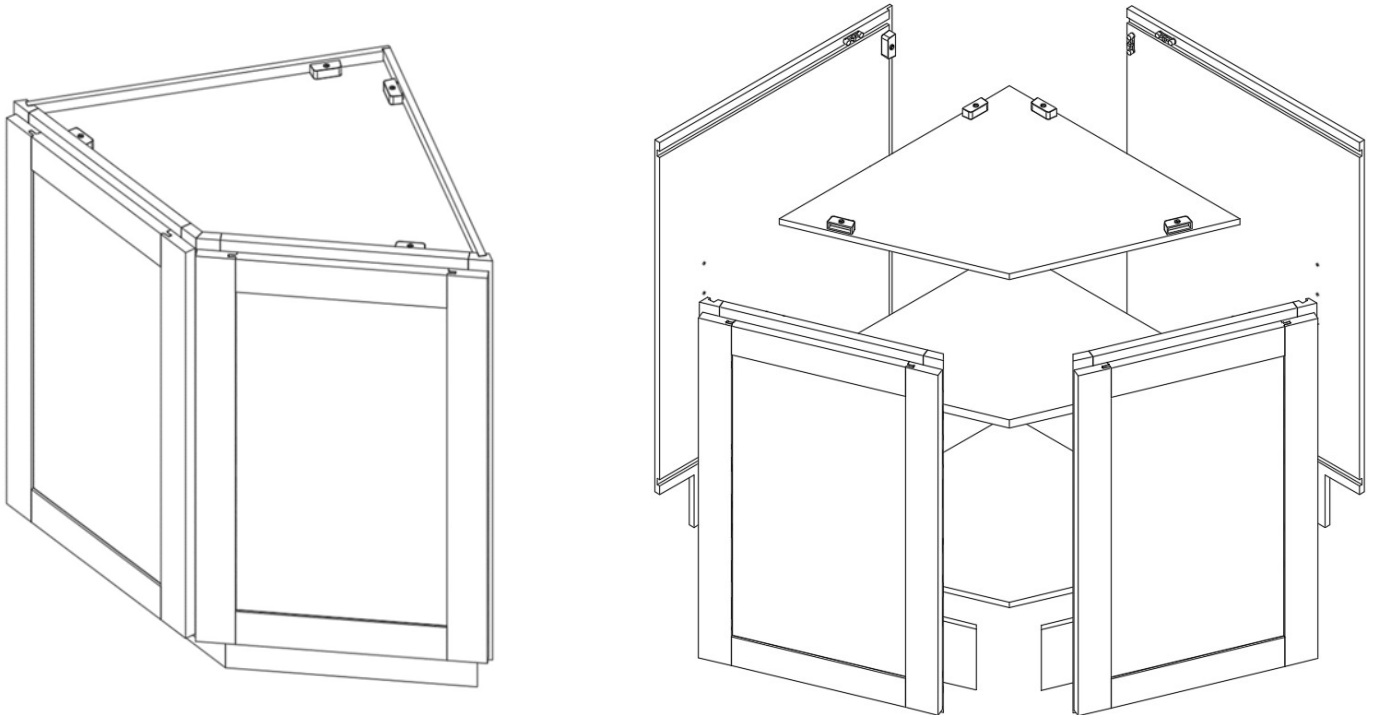



**ASSEMBLY INSTRUCTIONS**  
*[Shelf Bracket Installation]*



These assembly instructions are only applicable for all Angle Base Cabinets

**ITEM# AB124**

  
**WOW  
SERVICE**

**ATTENTION:** For questions or concerns about your cabinets, assembly or installation, please contact our dedicated Customer Care Team at **1-800-CABINET (222-4638)**. Our Customer Care associates are here for you every step of the way.

**► General Instructions:**

Thank you for purchasing a Cabinets To Go product. You are now the proud owner of a high quality product designed to face the test of daily use and guaranteeing your enjoyment for many years to come.

Carefully read the instructions before starting the installation.

During assembly, please follow all generally accepted safety procedures.

Failure to adhere to the following instructions will invalidate the warranty and Cabinets To Go will decline any responsibility for any damages caused. Any installation which does not correspond to the instructions may result in defects, malfunctioning parts, significant damage and/or injury.

Before the assembly begins, check that all appropriate and required plumbing and electrical connections exist.

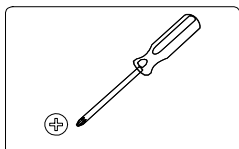
Before drilling, make absolutely sure that there are no pipes (gas, water, electricity, heating, etc.) at the drilling location. Cabinets To Go will not be held responsible for failure to follow these instructions.

PRIOR TO ASSEMBLY, PLEASE MAKE SURE YOU HAVE ONE FACE FRAME BOX AND ONE CARCASS BOX, WHICH HAVE ALL THE PARTS IN THE QUANTITIES MENTIONED BELOW. IF YOU ARE MISSING ANY PARTS, PLEASE STOP AND CONTACT CUSTOMER CARE IMMEDIATELY AT 1-800-CABINET.

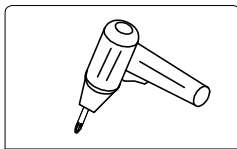
**► Items Quantity**

Item	Description	Qty
Hardware Box	90deg "L" Brackets 2pcs, 1/2" Round Head Screws 4pcs	

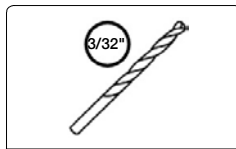
**► Required tools:**



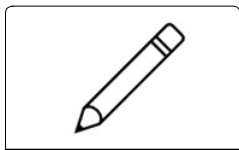
Tools Required: Phillips Screwdriver



Tools Required: Electric Drill



Tools Required: Drill Bit - 3/32"

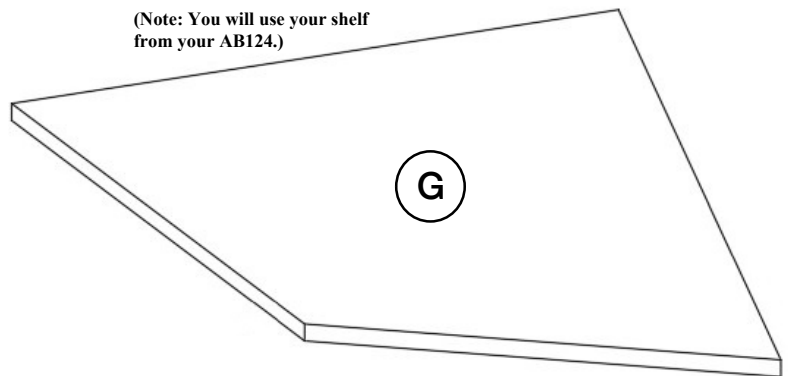


Tools Required: Marking Device



Tools Required: Measuring Device

(Note: You will use your shelf from your AB124.)



**► Hardware Box:**

**a**

**b**



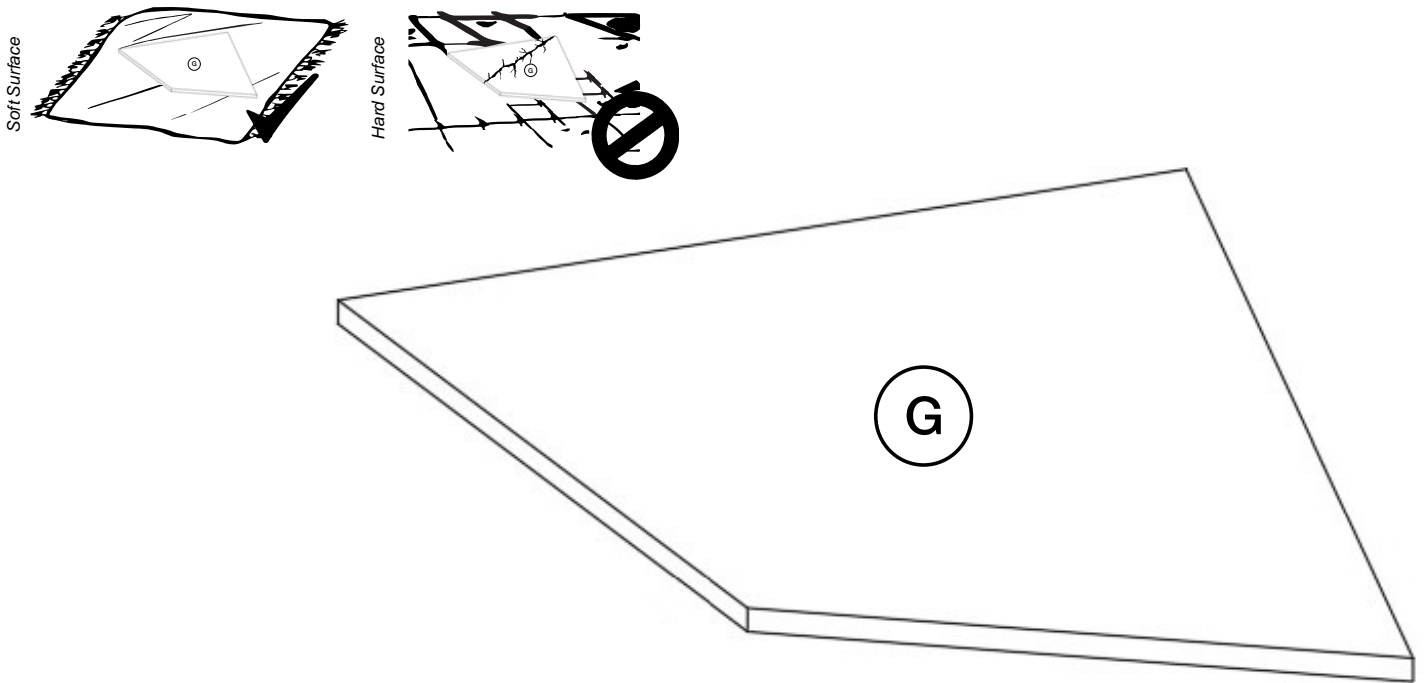
Qty 2

Qty 4

The materials listing above are for the largest unit in this instruction set. Smaller units may require less hardware and materials; therefore, your item may contain a smaller number of each.

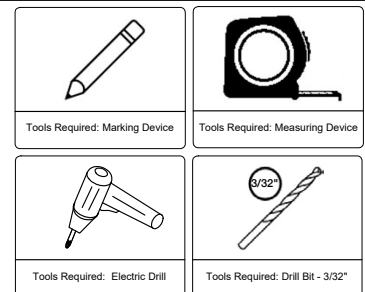
**► Instructions:**

- 1** Remove your existing shelf (G) if it is already installed into your AB124 cabinet. (Figure 1) *{NOTE: Lay panel G on a flat smooth soft work surface to prevent damages.}*

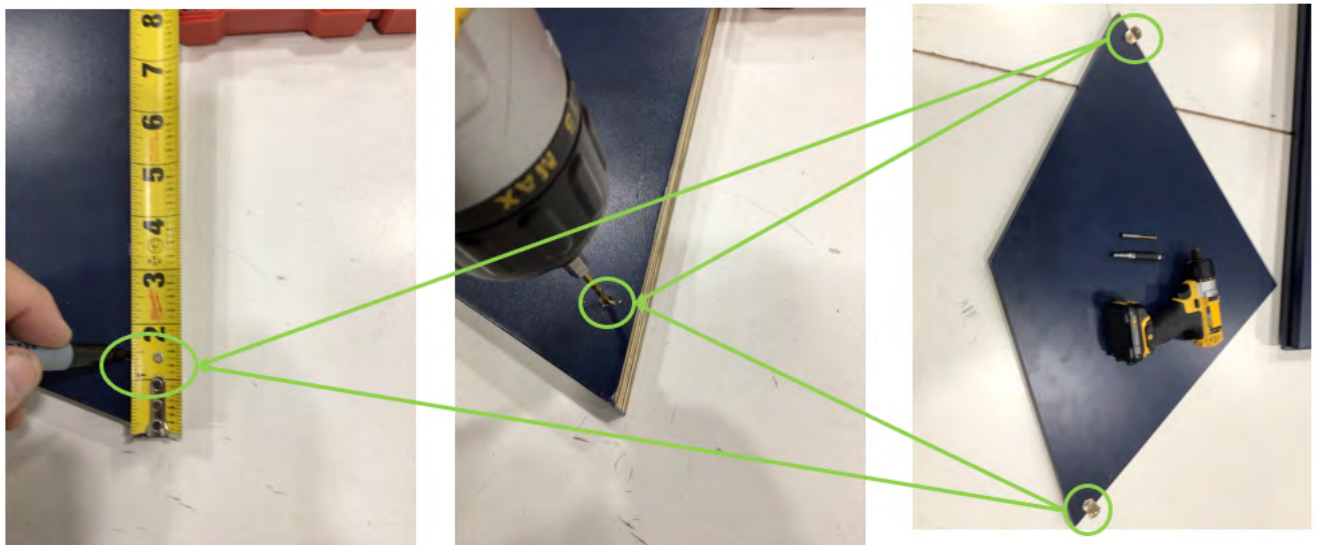


**Figure 1**

- 2** Measure approximately 1 1/2" in from front left and right corners and place a mark. Then place the 90° "L" bracket centered of your mark, and mark in center of hole. Remove brackets and drill a pilot hole about half way through with a 3/32" drill bit in both locations. (Note: This helps with installing screws.) Place brackets as shown and install screws.(Figure 2)




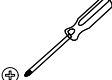


- a**  Qty 2
- b**  Qty 2



**Figure 2**

**3**

Install shelf in desired location with metal brackets on the underside of the shelf and mark center of bracket holes onto each side panel. Remove shelf again and pre-drill holes about half way through with a 3/32" drill bit where marked. Re-install shelf and screw brackets to the side panels. *(Note: Be careful as shelf may pull away from opposite side panel and potentially fall before you have screwed in both sides.)* (Figure 3)

 Tools Required: Marking Device	 Tools Required: Phillips Screwdriver
 Tools Required: Electric Drill	 Tools Required: Drill Bit - 3/32"

b



Qty 2



**Figure 3**

**► Maintenance**

For daily cleaning, use a dry cloth and a soft liquid cleaner.

Never use abrasive cleaners containing acetone, chlorine or strong bleach. Also, do not use tools as scrapers, metallic brushes, and other products which can scratch or tarnish surfaces.

Under no circumstances should you use chrome cleaner on chrome-plated or brass trim, hinges, handles, sockets etc.

Good ventilation is essential for maintaining the quality and look of this furniture.

**Warranty and Customer Care Information**

For the most up to date warranty information for your product, please visit our website - [www.cabinetstogo.com](http://www.cabinetstogo.com) to get the specific details. If you have any questions with warranties or to make a claim, please contact Customer Care by email - [customercare@cabinetstogo.com](mailto:customercare@cabinetstogo.com) or call 1-800-CABINET.