

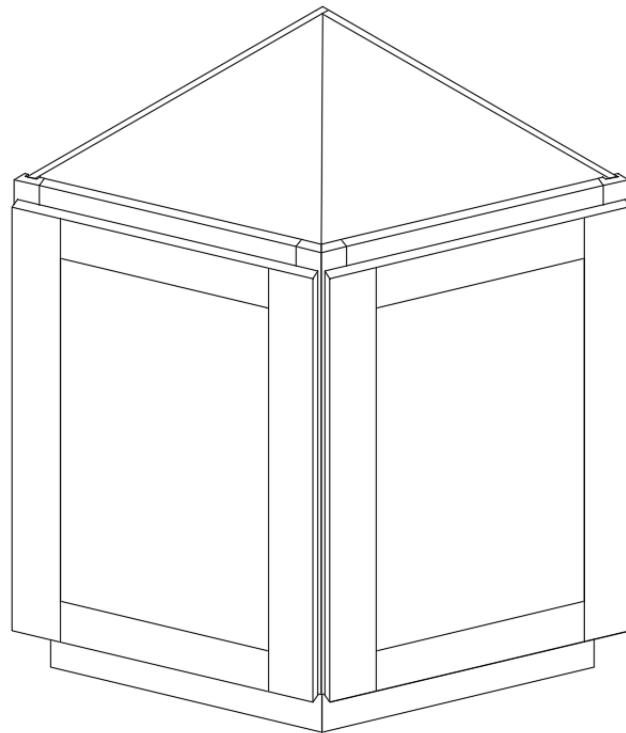

**Angle Base Cabinet  
ASSEMBLY INSTRUCTIONS**



These assembly instructions are only applicable for all Angle Base Cabinets  
**ITEM #AB124**

**WOW  
SERVICE**

**ATTENTION:** For questions or concerns about your cabinets, assembly or installation, please contact our dedicated Customer Care Team at **1-800-CABINET (222-4638)**. Our Customer Care associates are here for you every step of the way.

**► General Instructions:**

Thank you for purchasing a Cabinets To Go product. You are now the proud owner of a high quality product designed to face the test of daily use and guaranteeing your enjoyment for many years to come.

Carefully read the instructions before starting the installation.

During assembly, please follow all generally accepted safety procedures.

Failure to adhere to the following instructions will invalidate the warranty and Cabinets To Go will decline any responsibility for any damages caused. Any installation which does not correspond to the instructions may result in defects, malfunctioning parts, significant damage and/or injury.

Before the assembly begins, check that all appropriate and required plumbing and electrical connections exist.

Before drilling, make absolutely sure that there are no pipes (gas, water, electricity, heating, etc.) at the drilling location. Cabinets To Go will not be held responsible for failure to follow these instructions.

PRIOR TO ASSEMBLY, PLEASE MAKE SURE YOU HAVE ONE FACE FRAME BOX AND ONE CARCASS BOX, WHICH HAVE ALL THE PARTS IN THE QUANTITIES MENTIONED BELOW. IF YOU ARE MISSING ANY PARTS, PLEASE STOP AND CONTACT CUSTOMER CARE IMMEDIATELY AT 1-800-CABINET.

**► Items Quantity**

Item	Description	Qty
A	Face Frame and Door	2
B	Side Panel	1
C	Bottom Panel	1
D	Back Panel	1
E	Shelf	1
F	Toe Kicks	2
G	Hardware Box	1
	Bumper 4pcs, Plastic corner bracket 1pcs, "L" brackets 2pcs, Wood corner brackets 3pcs, 1/2" Flat Head Screws 4pcs, 1/2" Round Head Screws 2pcs,	
	1" Flat Head Coarse Thread Screws 14pcs, 1" Flat Head Screws 4pcs	

**► Required tools:**

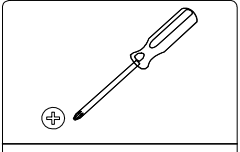
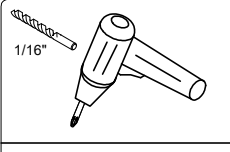
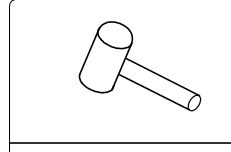
		
Tools Required: Phillips Screwdriver	Optional Tools: Electric Drill	Optional Tools: Rubber Mallet

**► Hardware Box:**

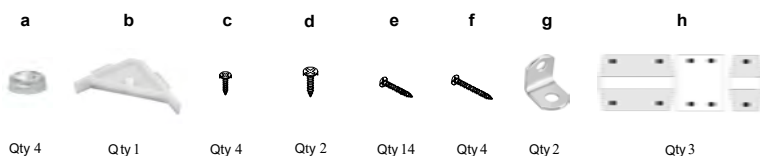

The materials listing above are for the largest unit in this instruction set. Smaller units may require less hardware and materials; therefore, your item may contain a smaller number of each.

**► Instructions:**

**1. Place Back Panel (D)** face down on a flat soft working surface (Figure 1).

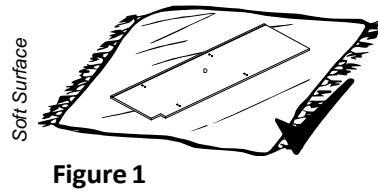
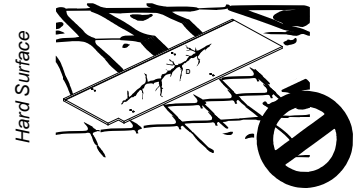

Figure 1



**2. Insert side panel (B)** into the grooves of back panel (D). (Figure 2) Align the plastic half part of the cam lock connectors. Make sure it fits and lock connectors with a screwdriver by turning the screw located on the cam lock connector to the right 180° (Figure 3)

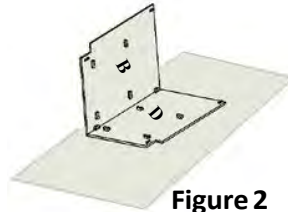

Figure 2

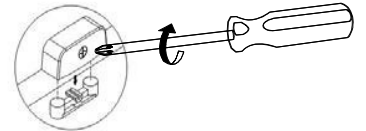

Figure 3

**3. Insert the bottom panel (C)** and shelf (E) (Figure 4), well align the cam locks and lock the connectors with a screwdriver by turning the screw located on the cam lock connector to the right 180° (Figure 3).

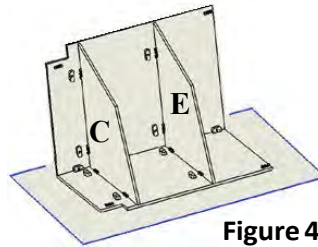

Figure 4

**4. Assembling the Face Frames:** Remove Door. Place one face frame (A) on a flat surface and install wood blocks (h) with screws (e) being careful of the placement. (Note: There are no pre-drilled pilot holes in the frames. You can use a 1/16" drill bit, drilling 1/4" deep, if needed.)

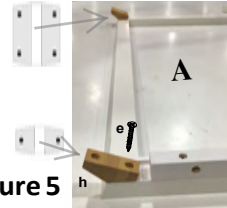
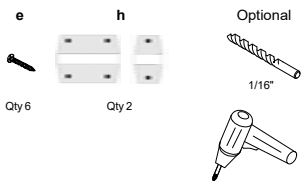

Figure 5

**5. Align the Frames** with the side and back panel. (Figure 6&7) Align the cam locks and lock them by turning the screw to the right 180° (Figure 3)

**Attach frames** to bottom panel using screws (f) insuring frame is flush with the bottom panel, and aligned with each other. (Figure 8) Finish attaching the frames to each other with the wooden blocks (h) that were attached in Step 4.

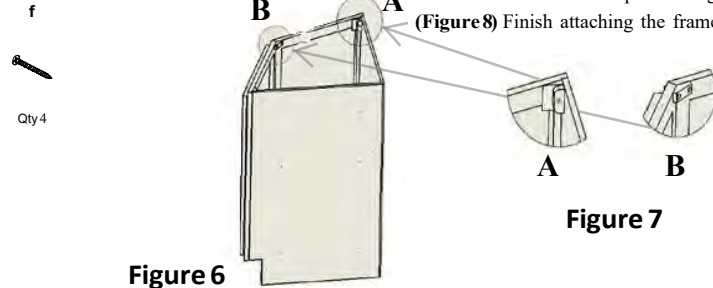

Figure 6

Figure 7

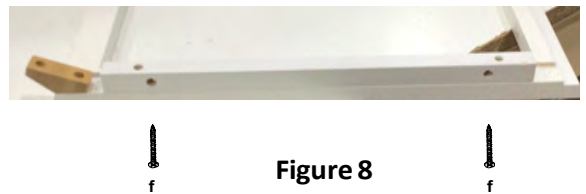

Figure 8

**6. Connect both Toe Kicks (F)** together with "L" brackets (g) with screws (c) (Figure 10A). Align the toe kicks with the cam locks at the bottom of the side and back panel. (Figure 9) Install the Toe Kicks (F) by locking the cam locks at both ends. (Figure 10B) Install the plastic corner bracket (b) with screws (d) (Figure 11&12).

Install the remaining wooden block (h) with screws (e) as a shelf support onto the frames. (Figure 11)

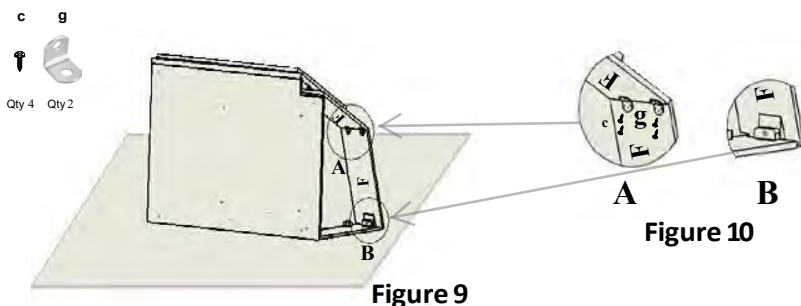

Figure 9

Figure 10

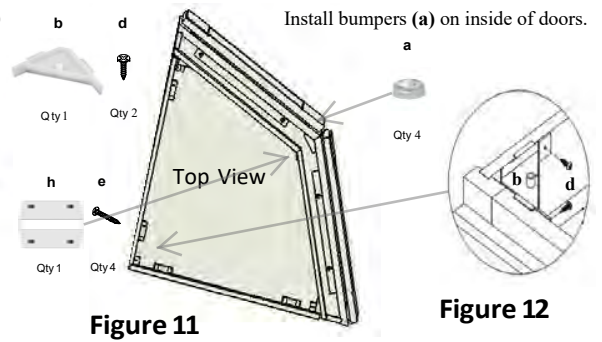

Figure 11

Figure 12

**► Maintenance**

For daily cleaning, use a dry cloth and a soft liquid cleaner.

Never use abrasive cleaners containing acetone, chlorine or strong bleach. Also, do not use tools as scrapers, metallic brushes, and other products which can scratch or tarnish surfaces.

Under no circumstances should you use chrome cleaner on chrome-plated or brass trim, hinges, handles, sockets etc.

Good ventilation is essential for maintaining the quality and look of this furniture.

**Warranty and Customer Care Information**

For the most up to date warranty information for your product, please visit our website - [www.cabinetstogo.com](http://www.cabinetstogo.com) to get the specific details. If you have any questions with warranties or to make a claim, please contact Customer Care by email - [customercare@cabinetstogo.com](mailto:customercare@cabinetstogo.com) or call 1-800-CABINET.