

Vanity Sink Base w/ Drawer

ASSEMBLY INSTRUCTIONS

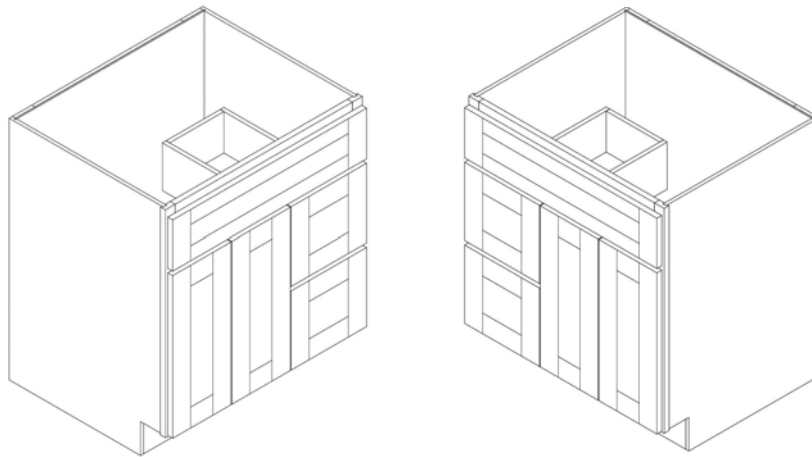

These assembly instructions are only applicable for all Vanity Sink Base w/Drawer
ITEM #VSB30DL, VSB30DR, VSB36DL, VSB36DR



ATTENTION: For questions or concerns about your cabinets, assembly or installation, please contact our dedicated Customer Care Team at **1-800-CABINET (222-4638)**. Our Customer Care associates are here for you every step of the way.

► **General Instructions:**

Thank you for purchasing a Cabinets To Go product. You are now the proud owner of a high quality product designed to face the test of daily use and guaranteeing your enjoyment for many years to come.

Carefully read the instructions before starting the installation.

During assembly, please follow all generally accepted safety procedures.

Failure to adhere to the following instructions will invalidate the warranty and Cabinets To Go will decline any responsibility for any damages caused. Any installation which does not correspond to the instructions may result in defects, malfunctioning parts, significant damage and/or injury.

Before the assembly begins, check that all appropriate and required plumbing and electrical connections exist.

Before drilling, make absolutely sure that there are no pipes (gas, water,electricity, heating, etc.) at the drilling location. Cabinets To Go will not be held responsible for failure to follow these instructions.

PRIOR TO ASSEMBLY, PLEASE MAKE SURE YOU HAVE ONE FACE FRAME BOX AND ONE CARCASS BOX, WHICH HAVE ALL THE PARTS IN THE QUANTITIES MENTIONED BELOW. IF YOU ARE MISSING ANY PARTS, PLEASE STOP AND CONTACT CUSTOMER CARE IMMEDIATELY AT 1-800-CABINET.

► **Items Quantity**

Item	Description	Qty
A	Face Frame with 2 Doors & 3 Drawer Fronts <i>(Drawer Fronts: 1 Long Fixed, 2 Short)</i>	1
B	Side Panels	2
C	Bottom Panel	1
D	Back Panel	1
E	Toe Kick	1
F	Drawer Box: Front 2pcs, Back 2pcs, Sides 4pcs, Bottom 2pcs	2
G	Hardware Box:	1
	Bumper 12pcs, Plastic corner bracket 4pcs, 1/2" round head screws 8pcs, 1" screws 10pcs, Slide Rails 2 Sets, Slide Rail Supports 4pcs	
	1/2" flat head screws for slides 12pcs	

► **Required tools:**

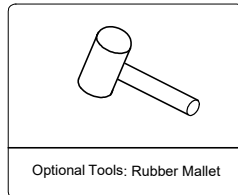
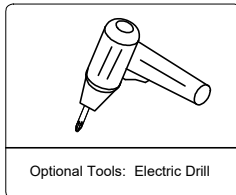
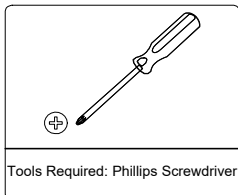

► **Hardware Box:**

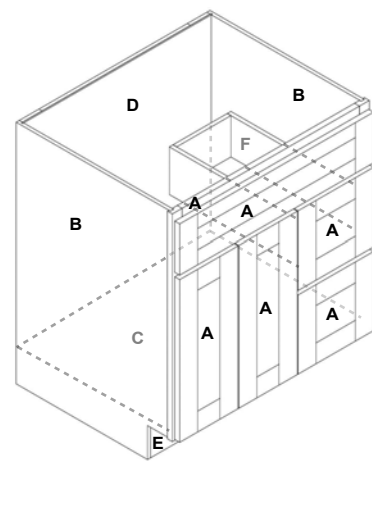
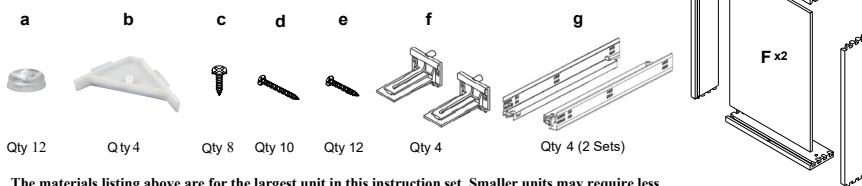

The materials listing above are for the largest unit in this instruction set. Smaller units may require less hardware and materials; therefore, your item may contain a smaller number of each.

► Instructions:

1. Place the face frame (A) face down on a flat soft working surface to ensure that the face is not scratched or damaged (Figure 1).

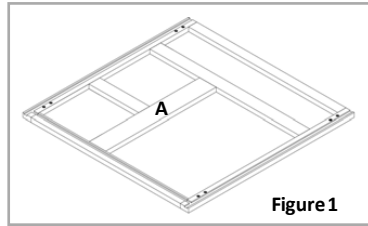

Figure 1

2. **Installing the Side Panels (Figure 2):** Insert right and left side panels (B) into the grooves of the face frame (A) and align the cam lock connectors (Figure 2). Lock the cam with a screw driver by turning the screw 180° clockwise (Figure 4).

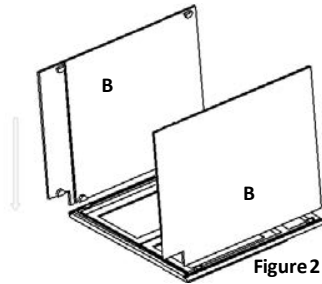

Figure 2

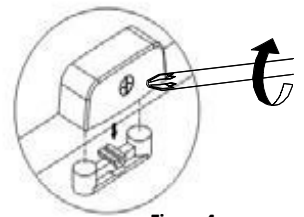

Figure 4

3. **Installing the Bottom (Figure 3):** Gently spread the side panels and insert the bottom (C) into the grooves of side panels (B) until it is seated in the face frame (A). Align it and lock each cam.

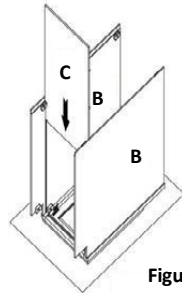
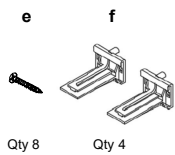

Figure 3

4. **Installing the Back Panel and Toe Kick (Figure 5):** Before you start this step, place the back panel (D) on a flat surface facing upward. Install the drawer rail holders (f) in the pre-spotted area on the back panel (Figure 6). Secure them with 2 flat head screws (e) (Figure 6). Place the back panel (D) at rear of side panels (B.) Align and lock each cam lock. Install the Toe Kick (E) by locking the cam lock at both ends (Figure 5).



Qty 8

Qty 4

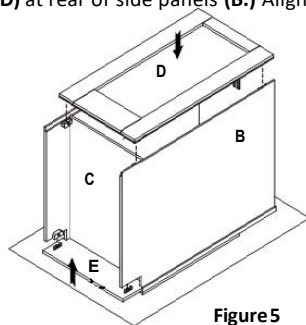
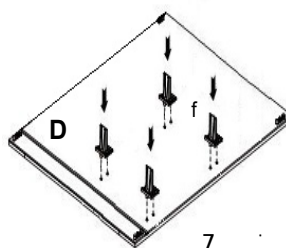
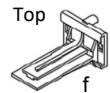
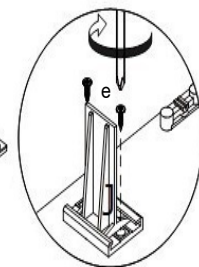

Figure 5



7



5. **Drawer Assembly (Figure 7):** First assemble the drawer front (A) with drawer box front (F) with screws (d). Then assemble the rest of the parts of the drawer box (F) using your palm, or a rubber mallet if needed, to secure the dove tails into position. Repeat step for 2nd drawer and set them aside.

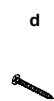

Qty 10

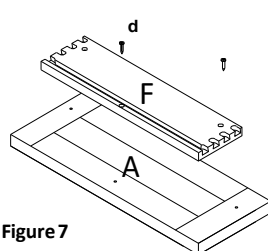
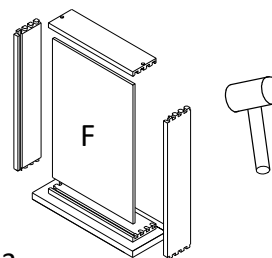
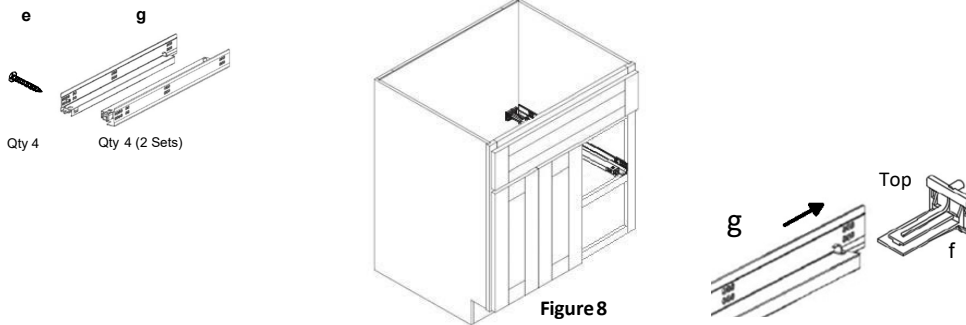

Figure 7



6. Install the Drawer Slide Rails: Insert the drawer side rail's back end (g) into the holder (f) previously installed (Step 4) on the back panel (D) (Figure 8). Then secure the drawer rail front end with 1/2" screws (e) using the pre-drilled holes in the face frame (A).



7. Installing the Corner Braces (Figure 9): Place the corner braces (b) on each top corner of the cabinet and secure them with the 1/2" Corner Brace Screws (c). Insert the assembled drawers from Step 5. Install the rubber bumpers (a) onto the corners of the doors and drawers (A) where they contact the frame.

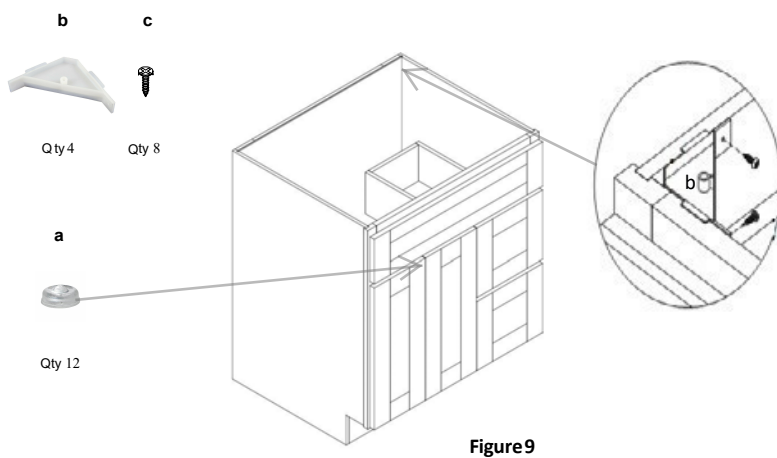

► Maintenance

For daily cleaning, use a dry cloth and a soft liquid cleaner.

Never use abrasive cleaners containing acetone, chlorine or strong bleach. Also, do not use tools as scrapers, metallic brushes, and other products which can scratch or tarnish surfaces.

Under no circumstances should you use chrome cleaner on chrome-plated or brass trim, hinges, handles, sockets etc.

Good ventilation is essential for maintaining the quality and look of this furniture.

Warranty and Customer Care Information

For the most up to date warranty information for your product, please visit our website - www.cabinetstogo.com to get the specific details. If you have any questions with warranties or to make a claim, please contact Customer Care by email - customer care@cabinetstogo.com or call 1-800-CABINET.