

Wall Cabinet
ASSEMBLY INSTRUCTIONS

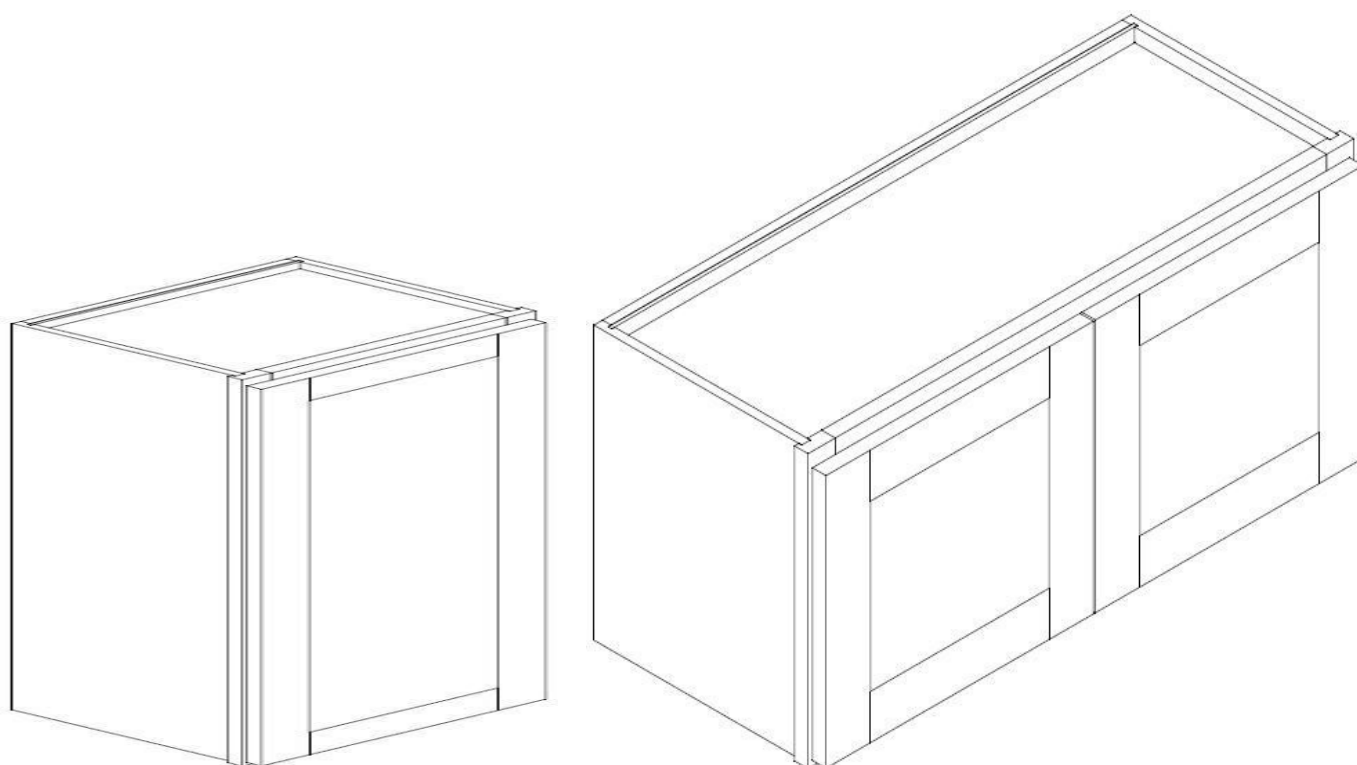

These assembly instructions are only applicable for all Wall Cabinets (no shelf)

ITEM #WC1212, WC1512, WC1812, WC2112, WC2412, WC2712, WC3012, WC3312, WC3612, WC3015, WC3315, WC3615, WC3018, WC3318, WC3618, WC3021, WC3321, WC3621, WC301224, WC301524, WC301824, WC302124, WC331224, WC331524, WC331824, WC332124, WC332418, WC361224, WC361524, WC361824, WC362124



ATTENTION: For questions or concerns about your cabinets, assembly or installation, please contact our dedicated Customer Care Team at **1-800-CABINET (222-4638)**. Our Customer Care associates are here for you every step of the way.

► General Instructions:

Thank you for purchasing a Cabinets To Go product. You are now the proud owner of a high quality product designed to face the test of daily use and guaranteeing your enjoyment for many years to come.

Carefully read the instructions before starting the installation.

During assembly, please follow all generally accepted safety procedures.

Failure to adhere to the following instructions will invalidate the warranty and Cabinets To Go will decline any responsibility for any damages caused. Any installation which does not correspond to the instructions may result in defects, malfunctioning parts, significant damage and/or injury.

Before the assembly begins, check that all appropriate and required plumbing and electrical connections exist.



Before drilling, make absolutely sure that there are no pipes (gas, water, electricity, heating, etc.) at the drilling location. Cabinets To Go will not be held responsible for failure to follow these instructions.

PRIOR TO ASSEMBLY, PLEASE MAKE SURE YOU HAVE ONE FACE FRAME BOX AND ONE CARCASS BOX, WHICH HAVE ALL THE PARTS IN THE QUANTITIES MENTIONED BELOW. IF YOU ARE MISSING ANY PARTS, PLEASE STOP AND CONTACT CUSTOMER CARE IMMEDIATELY AT 1-800-CABINET.





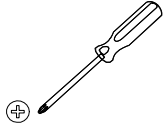

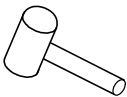
► Items Quantity

Item	Description	Qty
A	Face Frame with Door	1
B	Side Panels	2
C	Top & Bottom Panels	2
D	Back Panel	1
E	Hardware Box:	1
	"L" brackets 4pcs, 1/2" flat head screws 8pcs, 1" flat head screws 6pcs, 2" flat head screws 4pcs,	
	plastic wall anchors 4pcs, rubber bumpers 2-4pcs	

► Required tools:

		
Tools Required: Phillips Screwdriver	Optional Tools: Electric Drill	Optional Tools: Rubber Mallet

► Hardware Box:

					
Qty 4	Qty 8	Qty 6	Qty 4	Qty 4	Qty 4

The materials listing above are for the largest unit in this instruction set. Smaller units may require less hardware and materials; therefore, your item may contain a smaller number of each.

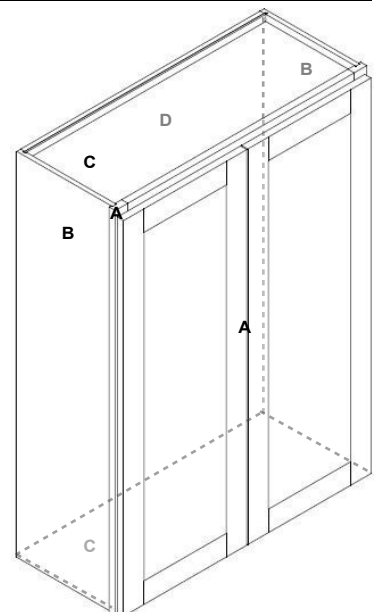

► **Instructions:**

1. Place the face frame (A) face down on a flat soft working surface to ensure that the face is not scratched or damaged (Figure 1).

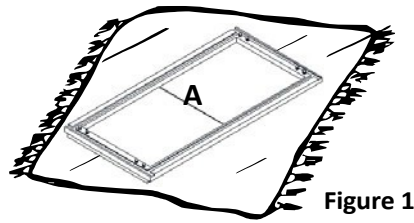

Figure 1

2. **Installing the Side Panels:** Insert the right and left side panels (B) into the groove of face frame (A) and align the cam lock connectors (Figure 2). Lock the cam lock with screwdriver by turning the screw 180° degrees clockwise (Figure 3).

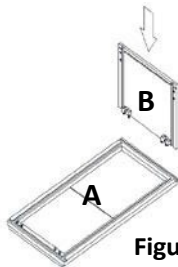

Figure 2

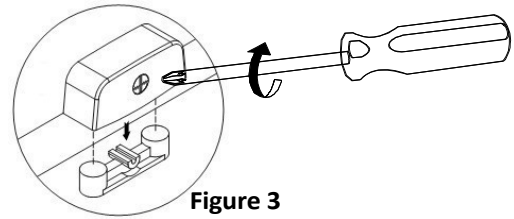

Figure 3

3. **Installing the Top and Bottom:** Gently spread side panels and insert top and bottom (C) into grooves of side panel (B) until they seat in the face frame (A) (Figure 4). Align them and lock each cam (Figure 3).

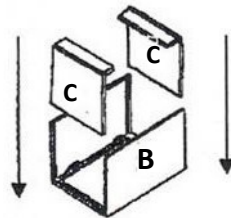

Figure 4

4. **Installing the Back Panel:** Insert and slide the back panel (D) into the groove in the rear of the side panel (B) (Figure 5). Align the back panel (D) and enforce it with 1 " Back Panel Screws (c) into the pre-drilled holes on the back panel.

c

 Qty 6

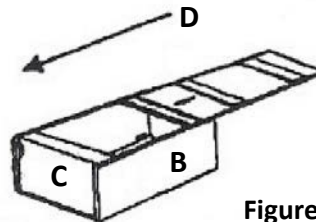
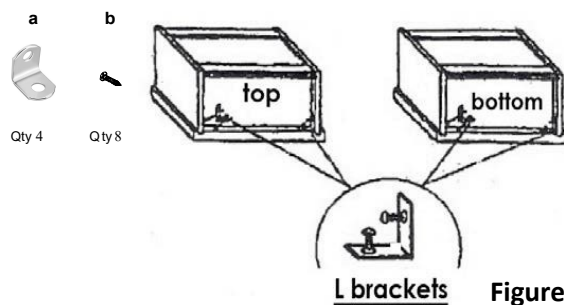

Figure 5

5. **Place the "L" brackets (a)** into the corner of the face frame and the side panels at the top and bottom of the cabinet. Then fasten the screws (b) to them as shown in (Figure 6). Install round buttons (f) where the doors come in contact with the frame. (Figure 7)



L brackets Figure 6

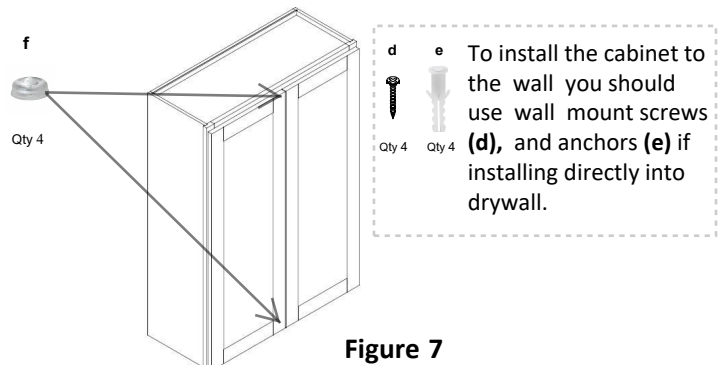
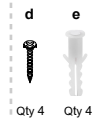

Figure 7

To install the cabinet to the wall you should use wall mount screws (d), and anchors (e) if installing directly into drywall.



► Maintenance

For daily cleaning, use a dry cloth and a soft liquid cleaner.

Never use abrasive cleaners containing acetone, chlorine or strong bleach. Also, do not use tools as scrapers, metallic brushes, and other products which can scratch or tarnish surfaces.

Under no circumstances should you use chrome cleaner on chrome-plated or brass trim, hinges, handles, sockets etc.

Good ventilation is essential for maintaining the quality and look of this furniture.

Warranty and Customer Care Information

For the most up to date warranty information for your product, please visit our website - www.cabinetstogo.com to get the specific details. If you have any questions with warranties or to make a claim, please contact Customer Care by email - customer care@cabinetstogo.com or call 1-800-CABINET.