

# ALADDIN

Leonardo Rossano

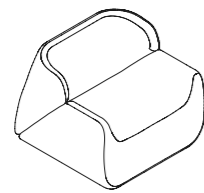

ARMCHAIR

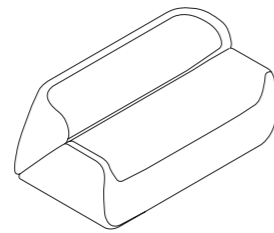

2 SEATER SOFA

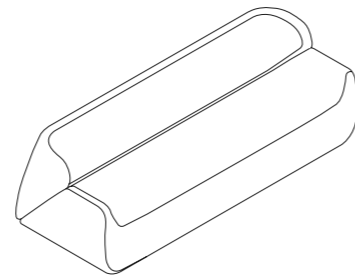

3 SEATER SOFA

## TECHNICAL FEATURES SPECIFICHE TECNICHE - SPÉCIFICATIONS TECHNIQUES

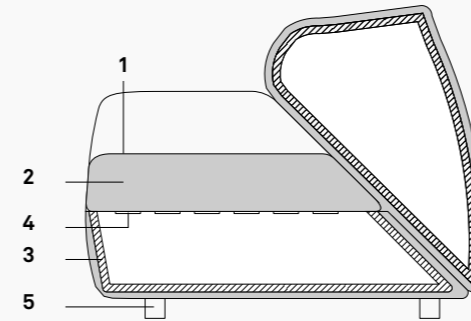

**1. Upholstery**  
Rivestimento  
Revetement

**2. High resistance foam**  
Poliuretano espanso indeformabile  
Mousse haute densité

**3. Wooden inner frame**  
Struttura interna in legno  
Structure interne en bois

**4. Elastic straps**  
Cinghie elastiche  
Bandes élastiques

**5. Polypropylene feet**  
Piedini in polipropilene  
Pieds en polypropilène

Inner wooden frame, seat with elastic bands, variable density flexible foam padding. Polypropylene feet.

Fusto in legno, seduta con cinghie elastiche; imbottitura in poliuretano espanso a densità differenziate. Piedini in polipropilene.

Structure interne en bois, assise avec bandes élastiques, rembourrée avec mousse à densité différenciée. Pieds en polypropilène.

**AL 1000**  
armchair  
poltrona  
fauteuil 1 place

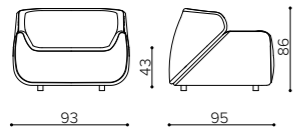

# m 5,3    ☆ mq 7,9    📦 kg 30    🪛 mc 0,5

**AL 2000**  
2 seater sofa  
divano 2 posti  
canapé 2 places

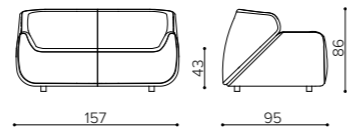

# m 7    ☆ mq 10,2    📦 kg 40    🪛 mc 1,3

**AL 3000**  
3 seater sofa  
divano 3 posti  
canapé 3 places

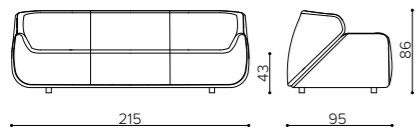

# m 9,7    ☆ mq 14    📦 kg 55    🪛 mc 1,75