

Name	Vistula (15mm Pipe Diameter)
Function	Mixer Tap / Faucet (Surface Mounted)
Material	Genuine Copper and Brass

A. Total Projection	150mm / 15cm / 5.90" Inches
B. Total Height	190mm / 19cm / 7.48" Inches
C. Tap Tail to Surface	78mm / 7.8cm / 3.07" Inches
D. Tap Tail Thread Diameter	1/2" Inch
E. Surface to Tap Turn	95mm / 9.5cm / 3.74" Inches
F. Pipe Inlet Centres	200mm / 20cm / 7.87" Inches
G. Mounting Surface	

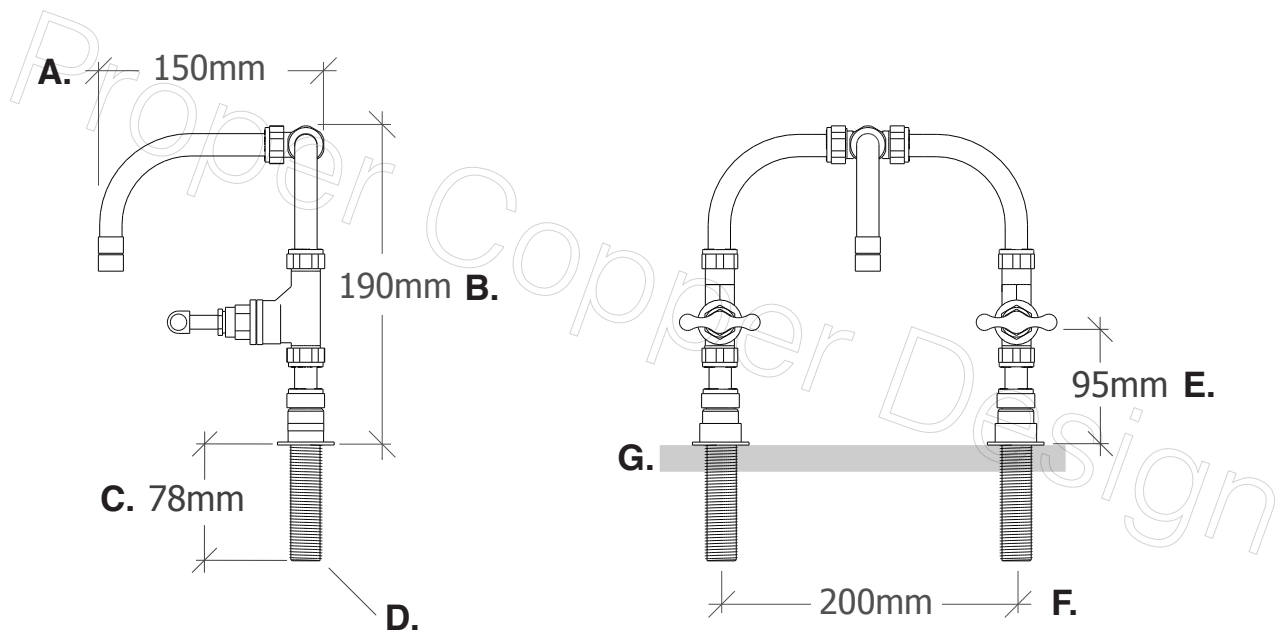

Custom sizes and finishes available upon request