

Name	Mekong
Function	Mixer Tap
Material	Genuine Copper and Brass

A. Total Projection	200mm / 20cm / 7.87" Inches
B. Total Height	340mm / 34cm / 13.38" Inches
C. Threaded tube to surface	78mm / 7.8cm / 3.07" Inches
D. Surface to Tap Turn	95mm / 9.5cm / 3.74" Inches
E. Pipe Inlet Centres	180mm / 18cm / 7.08" Inches

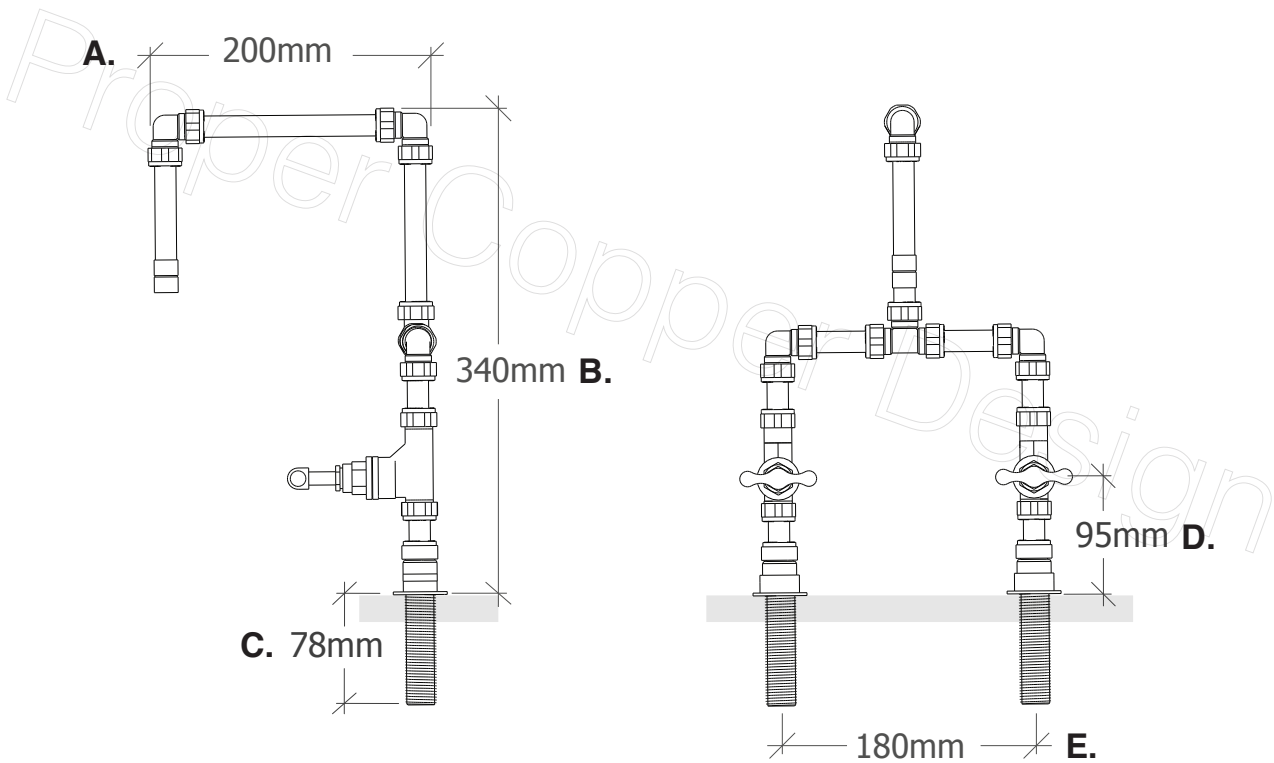

Custom sizes and finishes available upon request