



Use Zone: 29' x 37'



Age Range: 5-12 years



Occupancy: 15-20 children



Free Shipping!

Components: 6' Wave Slide / Deluxe Climbing Wall / 2'Tower Stairs / ADA Steps / 4'Straight Slide / Ultra Mountain Climber / Bongo Drums / Window Panel / Rainwheel / Bass Drum



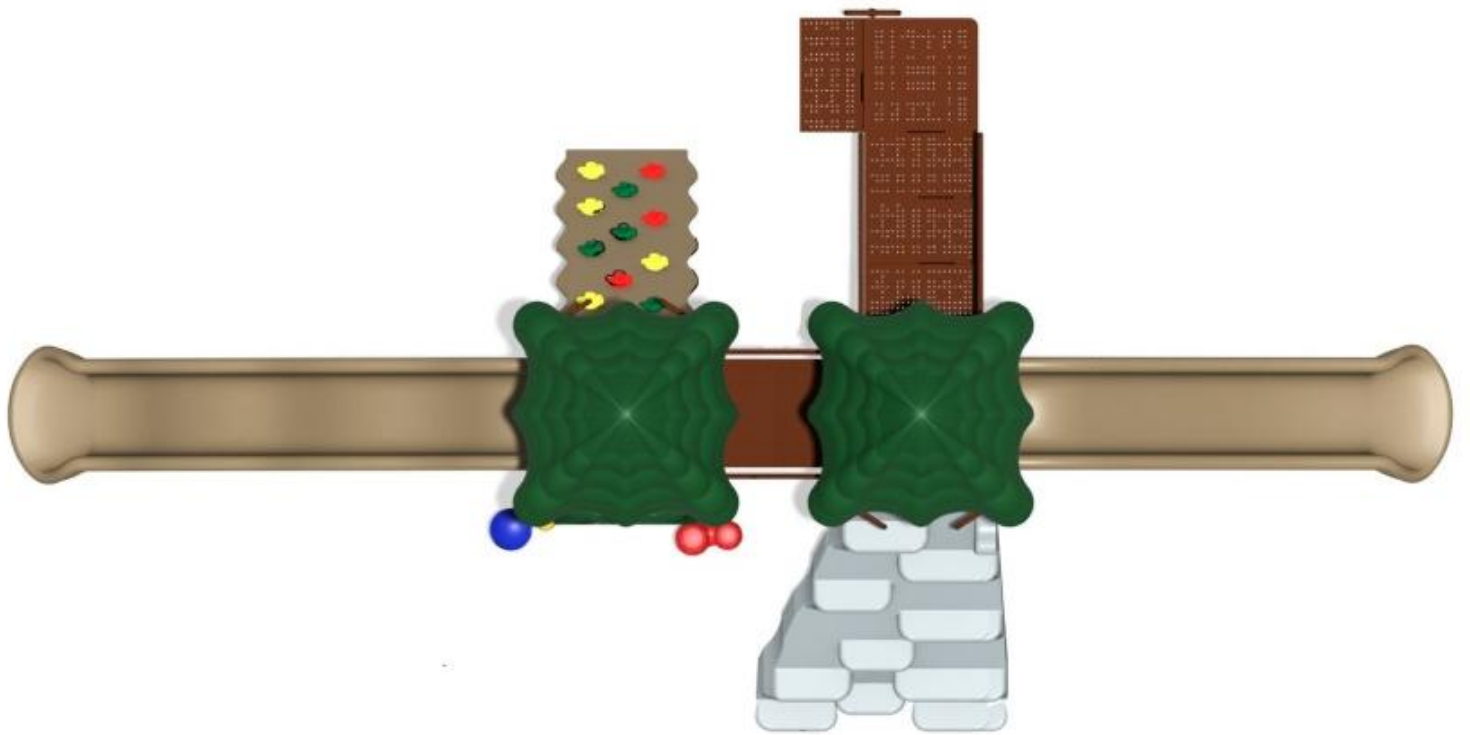





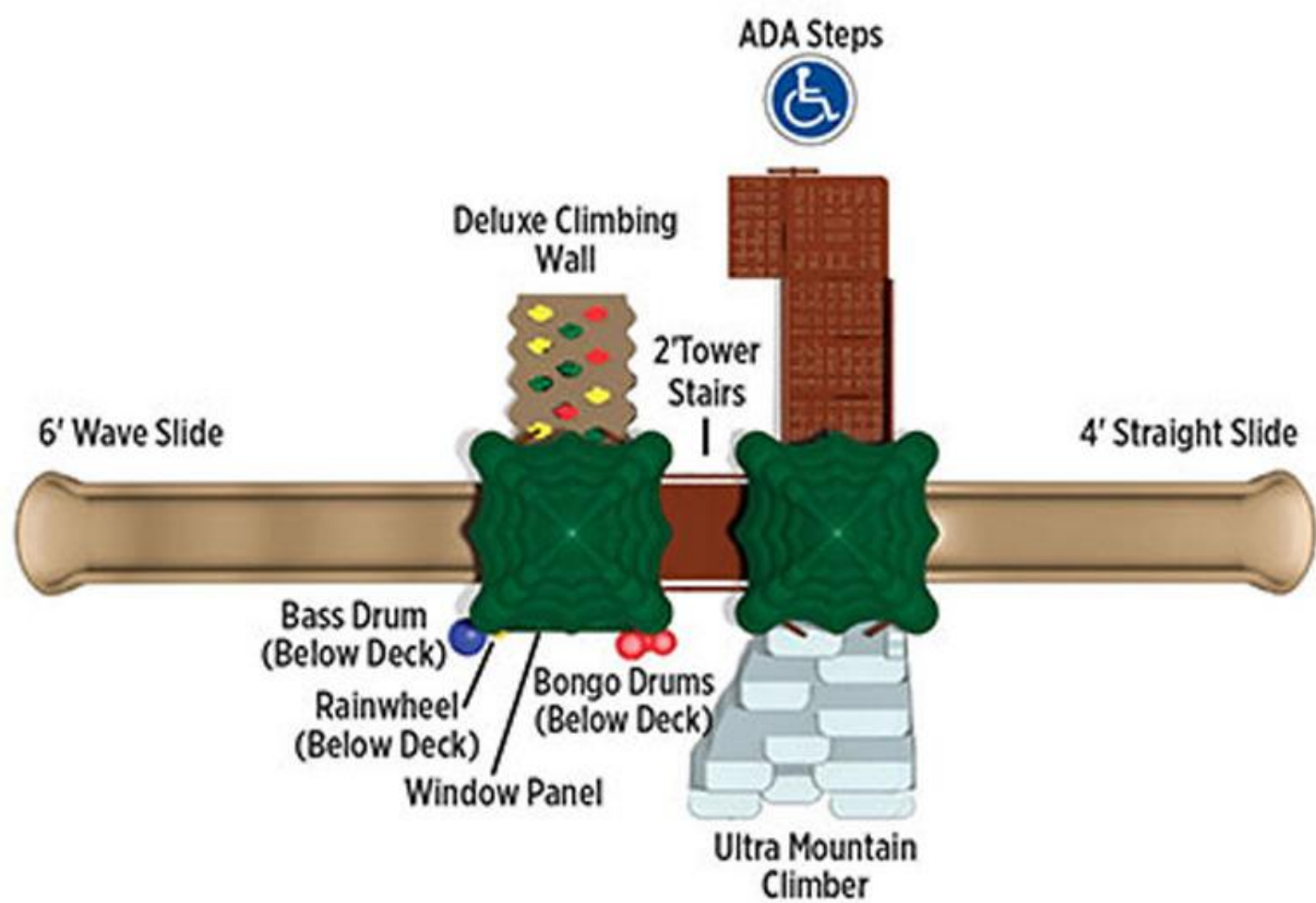

Ages: 5-12
 Capacity: 15-20 kids
 Fall height: 6'0"
 Activities 7
 Use Zone: 29' x 37"

Activities:

1. 6' Wave Slide
2. 6' Deluxe Rock Climb
3. 4' Straight Slide
4. Bass Drum
5. Bongo Drum
6. RainWheel
7. Ultra Mountain Climber



Reverse View



Formerly Up & UP



Footer Kit	Part Number	List Price
Ground Spike	33-12-0117	Included
Anchor Bolt	33-12-0054	
Ingound Kit	33-12-0096	

BIGHORN
5-12
FORMER UP & UP

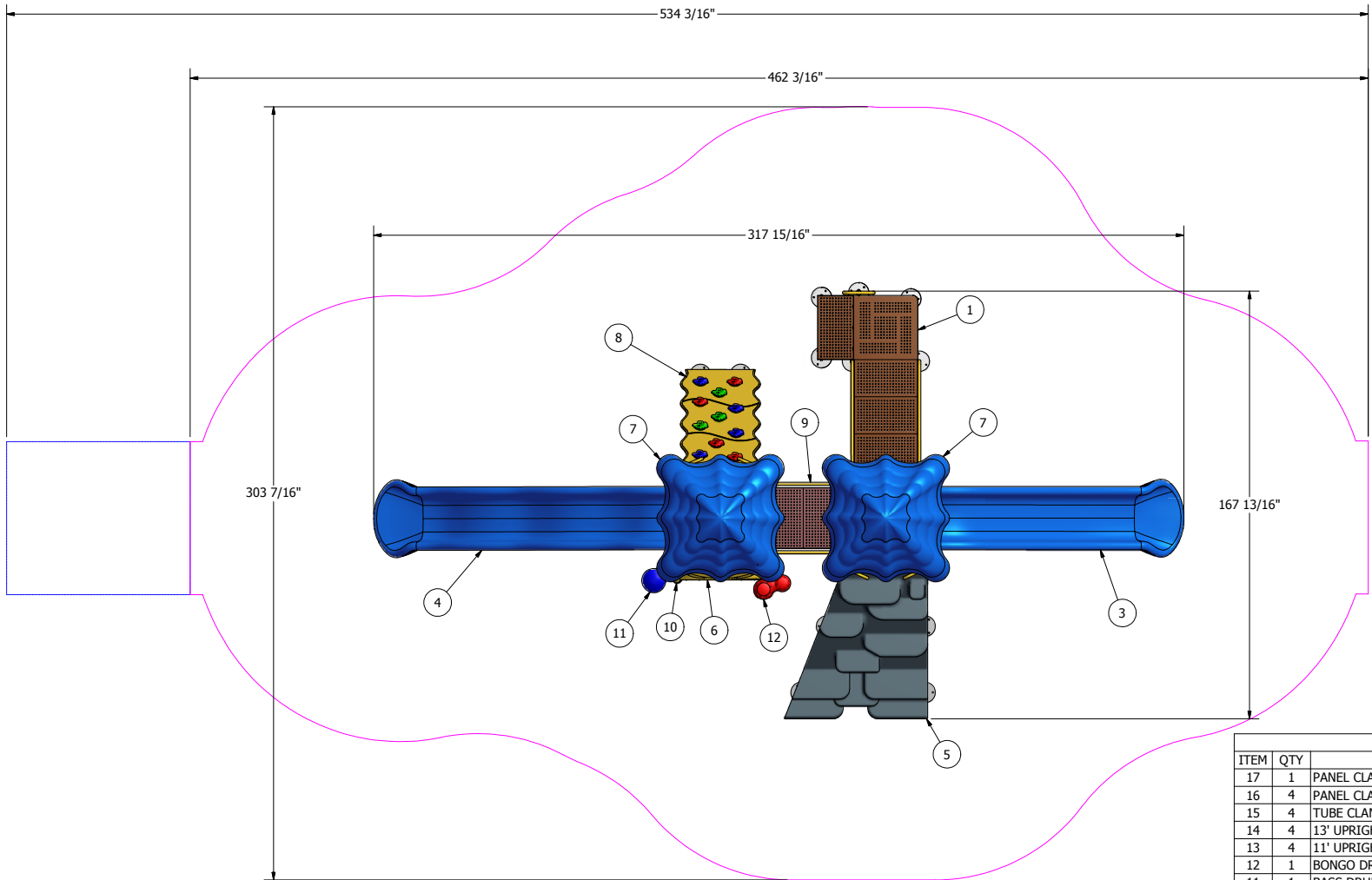

UPLAY-008

Parts List

ITEM	QTY	DESCRIPTION	PART NUMBER
17	1	PANEL CLAMP 90° DOUBLE	02-07-0041
16	4	PANEL CLAMP	02-07-0040
15	4	TUBE CLAMP	02-07-0039
14	4	13' UPRIGHT, CLAMP, & FOOTER	02-07-5029
13	4	11' UPRIGHT, CLAMP, & FOOTER	02-07-5028
12	1	BONGO DRUMS	02-07-5024
11	1	BASS DRUM w/TUBE CLAMP	02-07-5023
10	1	RAINWHEEL w/TUBE CLAMP	02-07-5022
9	1	2FT. STAIRS	02-07-5020
8	1	HDPE CLIMBER	02-07-5018
7	2	ROOF	02-07-5015
6	1	WINDOW PANEL	02-07-5010
5	1	ULTRA MOUNTAIN CLIMBER	02-07-5007
4	1	6FT. WAVE SLIDE	02-07-5006
3	1	4FT. STRAIGHT SLIDE	02-07-5004
2	2	SQUARE DECK	02-07-5001
1	1	4FT ADA STEPS	02-07-5000

FINISH ~ FORT PAYNE ~ **Ultra Play** ~ ALABAMA ~

This document contains proprietary information, and is not to be reproduced without written permission from Playcore and is not to be used in any manner detrimental to the interests of Playcore.

NAME: **BIGHORN**

TOLERANCE: ±1/16", 1"

NONACCUMULATIVE UNLESS OTHERWISE NOTED

DRAWN ppascuales	CK.	SCALE	DATE 11/25/2013	SHEET 1	OF 1
MFG. ENG.	APPROVED	ENGINEER	APPROVED	NO.	UPLAY-008

5 Reasons to **buy** UPLAY TODAY™

EASY
TO INSTALL

- 1 Easy to Install**
No Concrete or Digging Required



- 2 Ships in 5 Days**
Fast Delivery to Your Site



- 3 IPEMA Certified**
Meets Commercial Standards



- 4 ADA Accessible**
Meets ADA Requirements

\$SAVE
MONEY

- 5 Saves Money**
Affordable, Great for Volunteer Builds

Easy Set Up

UPlayToday™ is the commercial play solution for play spaces where residential equipment is not appropriate:

- Churches
- Early Childhood Centers
- Apartments
- Any Supervised Play Area
- Age appropriate for ages 2-5 or 5-12 years

Site Preparation

Review the area where your playground will be placed for:

- Space Available
- Facility Access
- Traffic Flow
- Flat Surface Area
- Tree & Utility Line Clearance

Three Ground Mounting Options

- 1 Ground Spike Surface Mount**
Included with all structures
(Not recommended for sandy or loamy soil conditions)

- 2 Anchor Bolt Surface Mount**
Sold separately

- 3 Concrete In-ground Mount**
Sold separately

Easy install!
No digging or concrete required.



Introducing **Augmented Reality!** Experience UPlayToday in a whole new Way!



1. Download the **FREE** app for mobile devices at get.layar.com or **scan** this QR code now.

2. Scan the page when you see the **ar** phone icon.

3. Watch videos, photos, and graphics emerge before your eyes!

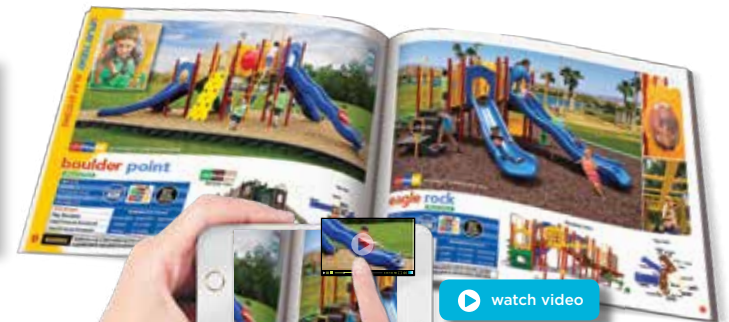

watch video

Core Features

- ★ **Robust 3½"** round steel uprights
- ★ **Premium quality** double wall roof, panels and slide entries
- ★ **Tested** at our IPEMA certified facility in the USA to meet ASTM, CPSC, and CSA standards
- ★ **Nature** details integrated throughout all structures
- ★ **Three** mounting options
- ★ **Multiple** ground level activities so everyone can play
- ★ **Select** designs available in space saver configurations for smaller use zones

2

Color Palettes

Playful (P)

Natural (N)

Limited Warranty

Plastic Parts	3 years
Metal Parts	5 years
Upright Posts	10 years



Add more ground level play with these **Add-on packages!**

Drums & Rain Wheel Set

Age: 2-5 or 5-12 Set includes: Bass Drum, Bongos and Rainwheel

Model	Color Scheme	Drums/Rain Wheel Color	Clamp Color
02-07-5009-YLW	Playful	As Shown	Red
02-07-5009-GRN	Natural	As Shown	Beige

Offer even more sound play with the Drums and Rain Wheel set. Activities that provide music and movement teach children about cause and effect while providing sensory development. Children will hear the different sounds made from the upbeat bongo drums, the deeper sound of the bass drum and the calming rush of the rain wheel. Set includes Bongo Drum, Bass Drum, and Rain Wheel. Add-on packages require 1-2 unobstructed posts. Ask your representative to help identify the best placement of components to enhance your structure.



Bench Panel

Age: 2-5 or 5-12

Model	Color Scheme	Bench Color	Clamp Color
02-07-5014-YLW	Playful	Yellow	Red
02-07-5014-GRN	Natural	Green	Beige

Provide children and adults a place to rest or gather with friends by adding the Bench Panel. Add to any two unobstructed posts.

Post Mount Ship's Wheel

Age: 2-5 or 5-12

Model	Color Scheme	Ship's Wheel Color	Clamp Color
02-07-5021-YLW	Playful	Blue	Red
02-07-5021-GRN	Natural	Beige	Beige

Encourage dramatic play by adding a Ship's Wheel to your structure. Children will also utilize fine motor skills as they spin and steer the Ship's Wheel. Add to any one unobstructed upright.



WARNING

Installation over a hard surface such as concrete, asphalt, or packed earth may result in serious injury from falls.



Safety Surfacing Solutions



Poured In Place Surfacing

Utilizing recycled products, SurfaceSure's Poured Rubber Surfacing offers a range of superior surfaces designed to fit any budget. These two-layered unitary products are impact absorbing, providing resilient non-skid surfaces that are an excellent choice for accessibility. The surface layer may be specified as one or a combination of colors, encouraging graphic designs that can range from custom logos to simple games like tic-tac-toe and hopscotch. These graphics can be utilized to enhance ground level play on every playground, thus increasing play value.



Be sure to use an **IPEMA-certified** surfacing specialist.



Create custom colors and save money by blending varying amounts of black and color!



Interlocking & Standard Tiles

We offer Interlocking Tiles and Standard Tiles (individually glued to sub-base) to meet your site-specific needs. SurfaceSure Tiles are available in various thicknesses to provide the appropriate amount of impact attenuation for the fall height of your structure or play event. Tile surfacing allows for easy replacement of small areas of surfacing in the event of vandalism or other damage. Premium multicolored tiles, highly durable EPDM-topped tiles, custom edging options, and ADA accessible ramp tiles are also available.

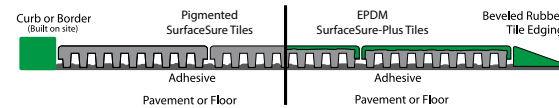

Be sure to use an **IPEMA-certified** surfacing specialist.



Interlocking

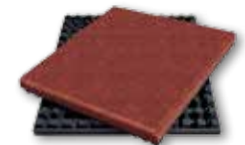

Standard



Engineered Wood Fiber

SurfaceSure Engineered Wood Fiber is specifically designed and engineered per the ASTM standard for impact attenuation on playground surfaces. Wear Mats, Geotextile Fabric, Border Timbers, along with periodic maintenance (including adding fiber) are needed to maintain the required depth. When compacted, SurfaceSure Engineered Wood Fiber meets the ASTM standard specification for determination of accessibility of surface systems for playgrounds.



Made from recycled materials

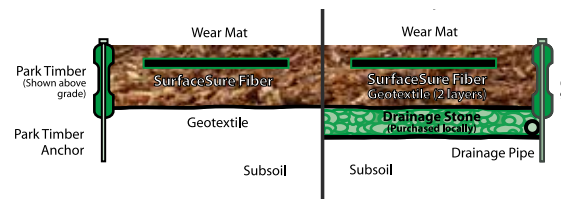

Be sure to use an **IPEMA-certified** surfacing specialist.



Border Timbers

Made from 100% recycled materials, our border timbers are designed to retain engineered wood fiber surfacing. These timbers are easy to install and are secured with ground spikes.



UPlay Today™ Product Specifications

General System Specifications:

UPlay Today™ features 3^{1/2}" O.D. uprights with a high-strength aluminum alloy clamp fastening system finished with a polyester powder-coat. All uprights shall receive factory installed deck clamps located at the appropriate deck heights.

All decks and components shall connect using the aluminum clamping system. All climbing attachments shall include either upright-mounted grab bars or a 15" wide deck entry archway to control deck access to one child at a time and help prevent inadvertent falls.

UltraPlay shall offer the following warranties on the materials and components of the UPlay Today™ playsystems:

- 10-Year limited warranty on support posts (uprights)
- 5-Year limited warranty on metal parts including decks, pipes, rails, loops and rungs
- 3-Year limited warranty on rotationally molded polyethylene components
- 1-Year limited warranty on all hardware and all UltraPlay products in general

Clamps

All clamps are die cast, high-strength 102 aluminum and are powder-coated to match the post color. Fasteners for clamps are stainless steel special tamper-resistant pinned bolt with locking patch, and a heavy hex locknut, which fits into either a hex or round shaped recess, cast into the clamp. The pinned bolt head requires a special tool for fastening (provided with each structure), thus ensuring vandal-resistance.

Plastisol Coating

All metal deck platforms, steps and stairs are plastisol-coated. Each part is chemically washed and completely submerged in a special heat-activated primer and allowed to dry. Parts are then pre-heated and immersed in liquid polyvinyl-chloride (plastisol). The PVC coating shall have a nominal thickness of .080" and a hardness of Shore A 83 +/-5 normal durometer range. This material is classed as "Self Extinguishing", meets or exceeds automotive specifications NVSS302, and contains ultraviolet inhibitors to help prolong the life of the coating. Standard color is brown. The following characteristics apply:

Tensile Strength - 2,800 psi
Elongation - 290 %
Tear Strength - 420 lbs/in

This product meets or exceeds the heavy metal requirements of the CPSIA Act of 2008.

Powder-Coating Process

Powder-coat shall be an electrostatically applied formula of polyester powder. All components will be free of sharp edges and excess weld spatter and shall be cleaned in an iron phosphate wash, as a rust inhibitor, and a sealer to prevent flash rusting before coating. The coating shall have a super tough finish with maximum exterior durability and will have superior adhesion characteristics.

Rotationally Molded Plastics

All Rotationally Molded Products are manufactured from medium density polyethylene (UV-stabilized color). The tensile strength of this material is to be 2500 PSI as defined by ASTM D638. The nominal wall thickness will be .250" (1/4"). All rotationally molded products shall meet or exceed the following specifications:

Melt Index (ASTM D-1238); Density (ASTM D- 1505); Tensile Values (ASTM D-638); Flexural Stiffness (ASTM D-747); IZOD Impact Strength (ASTM D256); Vicat Softening Point (ASTM D-1525); Brittleness Temperature (ASTM D746); Shore Hardness (ASTM D2240).

Blow Molded Plastics

All Blow Molded Products are manufactured from high-density polyethylene. The nominal wall thickness will be .200". All blow molded products shall meet or exceed the following specifications:

ASTM-D 1248 Type III, Class A, Category 5; Melt Index (ASTM D-1238); Density (ASTM D- 1505); Tensile Values (ASTM D-638); Flexural Modulus (ASTM D-790); IZOD Impact Strength (ASTM D256); Brittleness Temperature (ASTM D746).

HDPE Components

Climbers shall be precision cut from a single solid sheet of .59" thick UV-stabilized extruded high-density polyethylene. All edges shall have radiuses and all corners rounded for safe play.

Hardware

All nuts, bolts, and washers, with exceptions noted, shall be stainless steel Grade 304 in varying lengths, with a vandal-resistant button-pinned head configuration and factory-applied locking patch. When allowed a 72-hour cure time, the locking patch will prevent the bolt from loosening without at least 4 times the installation torque. UltraPlay will supply the special tool required to turn vandal-resistant hardware with each shipment.

Uprights – Steel

The posts shall be 3 1/2" O.D. 13-gauge galvanized steel tubing. Entire post is powder coated after fabrication.



UPlay Today™ Warranty

UltraPlay Systems, Inc. warrants its products to be free from defects in materials and/or workmanship, subject to normal usage and installation, for a period of 1-year from the date of shipment to the original purchaser. In the event of a claim under this warranty, UltraPlay Systems will replace the component at no cost within the first 12 months from date of shipment to the original customer. Equipment not specifically addressed in the following paragraphs is also subject to this limited 1 year warranty against defects in materials and/or workmanship.

TEN-YEAR LIMITED WARRANTY ON UPRIGHT POSTS

UltraPlay Systems provides a limited warranty on metal upright posts to be free from defects in materials or workmanship against structural failure which causes the product to become unfit for its intended use, subject to normal usage and installation, for a period of 10 years from the date of shipment to the original customer.

FIVE-YEAR LIMITED WARRANTY ON METAL PARTS

UltraPlay Systems provides a limited warranty on metal decks, steps, stairs, rails, pipes, support posts, rungs, loops, swing frame yokes and clamps to be free from defects in materials or workmanship against structural failure which causes the product to become unfit for its intended use, subject to normal usage and installation, for a period of 5 years from the date of shipment to the original customer.

FIVE-YEAR LIMITED WARRANTY ON GROUND-MOUNT METAL PARTS

UltraPlay Systems provides a limited warranty on metal footers, inground footers, surface mount plates, ground spikes, slide and climber mounting posts and plates to be free from defects in materials or workmanship against structural failure which causes the product to become unfit for its intended use, subject to normal usage and installation, for a period of 5 years from the date of shipment to the original customer.

THREE-YEAR LIMITED WARRANTY ON PLASTIC PARTS

UltraPlay Systems provides a limited warranty on the following plastic parts: slides, climbers, roofs, tunnels, bridges, panels and border timbers. These components are warranted to be free from defects in materials or workmanship, subject to normal usage and installation, for a period of 3 years from the date of shipment to the original customer.

ONE-YEAR LIMITED WARRANTY ON HARDWARE

UltraPlay Systems provides a limited warranty on hardware to be free from defects in materials or workmanship against structural failure due to breaking or shearing, subject to normal use and installation, for a period of 1 year from the date of shipment to the original customer.

ONE-YEAR LIMITED WARRANTY ON HDPE CLIMBERS AND HDPE SPRING RIDERS

UltraPlay Systems provides a limited warranty on high density polyethylene (HDPE) climbers and spring riders against degradation for a period of 1 year from the date of shipment to the original customer.

ONE-YEAR LIMITED WARRANTY ON SPRING RIDER METAL PARTS

UltraPlay Systems provides a limited warranty on metal springs, bases and brackets of spring riders to be free from defects in materials or workmanship against structural failure which causes the product to become unfit for its intended use, subject to normal usage and installation, for a period of 1 year from the date of shipment to the original customer.

ONE-YEAR LIMITED WARRANTY ON STRAP AND TOT SEAT

UltraPlay Systems provides a 1 year limited warranty on strap and tot swing seats against structural failure that causes the seat to become unfit for its intended use. Additionally, chain, "S"- hooks and hangers are covered under a one-year limited warranty.