

Midea Gas Cooktop Instruction

MODEL : MCG601GBL



SAVE THESE INSTRUCTIONS CAREFULLY

Read these instructions carefully before using your gas cooktop, and keep it carefully. If you follow the instructions, your gas cooktop will provide you with many years of good service.

Preface

Thank you for choosing our gas cooktop.

To use this appliance correctly and prevent any potential risk, read these instructions before using the appliance.

Keep these instructions in a place where you can find them easily.

If you are unsure of any of the information contained in these instructions, please contact our customer care centre.

The manufacturer shall not be responsible for any damages to persons or property caused by incorrect installation or use of the appliance.

The appliance has been certified for use in countries other than those marked on the appliance.

The manufacturer also reserves the right to make any modifications to the products as may be considered necessary or useful, also in the interests of the user, without jeopardising the main functional and safety features of the products themselves.

The appliance is designed for a domestic environment and not a commercial one.

contents

Preface

Safety Warning

3	Safety Instructions
4	Installation
5	Child and People Safety
6	During Use
8	Cleaning and Service
8	Environmental Information

Instructions for use and maintenance



9	Description of the appliance
10	How to Use the appliance
12	Safety and Energy saving advice
13	Cleaning and Maintenance

Technical instructions

15	Using instructions
16	Positioning
17	Installing the appliance
18	Gas Connection
21	Gas Specifition
22	Electrical Connection
23	Gas adjustment
24	Trouble shooting

Safety Instructions

- Please take the time to read this Instruction Manual before installing or using the appliance.
- This instruction booklet must be kept with the appliance for any future reference.
If the appliance is sold or transferred to another person, ensure the booklet is passed on to the new user.
- The manufacturer declines any liability should these safety measures not be observed.
- The following marks are made to be easily understood so that you can prevent any accident caused by misuse in advance, and use the appliance more conveniently.
- Read the following contents thoroughly and ensure you understand them.

 Danger/Warning	Neglect of this mark may result in severe personal injury or death.
 Caution	Neglect of this mark may result in minor personal injury or property damage.

- **The following marks are used in the Instruction Manual as follows:**

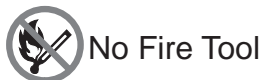

- **If gas seems to leak, take the actions as follow:**

- Do not turn on the light.
- Do not switch on/off any electrical appliance and do not touch any electric plug.
- Do not use a telephone.
 - 1 Stop using the product and close the middle valve.
 - 2 Open the window to ventilate.
 - 3 Contact our service centre by using a phone outside.

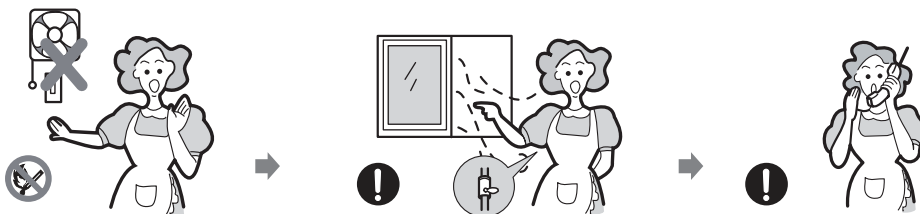

* The fuel gas contains mercaptan, so that you can smell the gas leak (smell of rotten garlic or egg) even where only 1/1000 of the gas is in the air.

Installation

Warning

- This appliance shall be installed in accordance with regulations in force and only used in a well ventilated space.

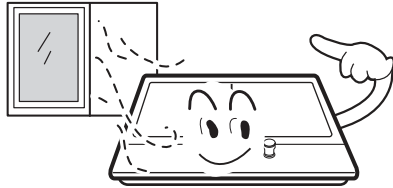

- Prior to installation, ensure that the gas and electrical supply complies with the type stated on the rating plate.

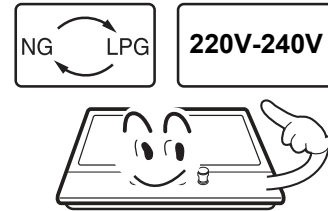

- Where this appliance is installed in marine craft or in caravans, it should not be used as a space heater.

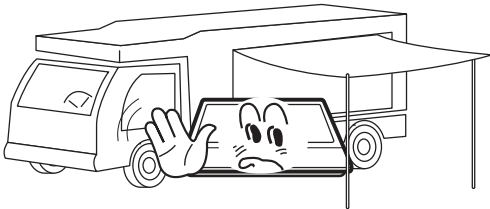

- The gas pipe and electrical cable must be installed in such a way that they do not touch any parts or the appliance.

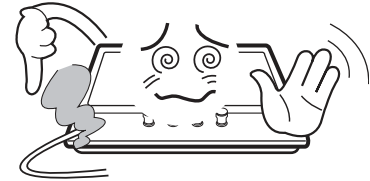

Caution

- This appliance should be installed by a qualified technician or installer.
- The adjustment conditions for this appliance are stated on the label or data plate.
- Remove all packaging before using the appliance.
- After unpacking the appliance, make sure the product is not damaged and that the connection cord is in perfect condition. Otherwise, contact the dealer before installing the appliance.
- The adjacent furniture and all materials used in the installation must be able to withstand a minimum temperature of 85°C above the ambient temperature of the room it is located in, whilst in use.
- In the event of burner flames being accidentally extinguished, turn off the burner control and do not attempt to re-ignite the burner for at least one minute.
- The use of a gas cooking appliance results in the production of heat and moisture in the room in which it is installed. Ensure that the kitchen is well ventilated: keep natural ventilation holes open or install a mechanical ventilation device (mechanical extractor hood).
- Prolonged intensive use of the appliance may call for additional ventilation, for example opening of a window, or more effective ventilation, for example increasing the level of mechanical ventilation where present.

Child and People Safety

Warning

- Do not allow children to play near or with the appliance.
The appliance gets hot when it is in use.
Children should be kept away until it has cooled.

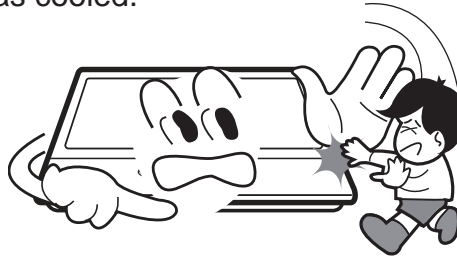

Caution

- This appliance is designed to be operated by adults.
- Children can also injure themselves by pulling pans or pots off the appliance.
- This appliance is not intended for use by children or other persons whose physical, sensory or mental capabilities or lack of experience and knowledge prevents them from using the appliance safely without supervision or instruction by a responsible person to ensure that they can use the appliance safely.

During Use

Warning

- Only use the appliance for preparing food.

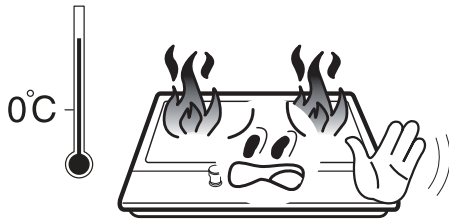

- Do not modify this appliance. Burner panel is not designed to operate from an external timer or separate remote control system.

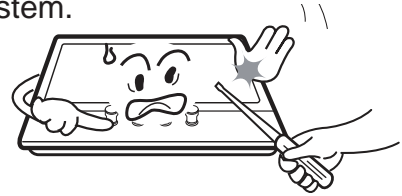

- The use of a gas cooking appliance results in the production of heat and moisture in the room in which it is installed. Ensure that the kitchen is well ventilated : keep natural ventilation holes open or install a mechanical ventilation device (mechanical extractor hood).



- Do not use this appliance if it comes in contact with water. Do not operate this appliance with wet hands.



- The heating and cooking surfaces of the appliance become hot when they are in use, take all due precautions.



- Do not use large cloths, tea towels or similar as the ends could touch the flames and catch fire.

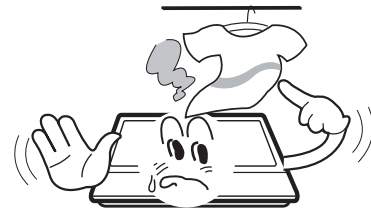

- Never leave the appliance unattended when cooking.



- Unstable or misshapen pans should not be used on the appliance as they can cause an accident by tipping or spillage.

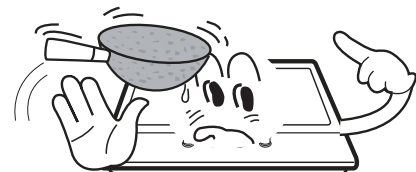

During Use

- Do not use or store flammable materials in the storage drawer near this appliance.



- Perishable food, plastic items and aerosols may be affected by heat and should not be stored above or below the appliance.



- Do not spray aerosols in the vicinity of this appliance while it is in operation.



- Ensure the control knobs are in the '●' position when not in use.

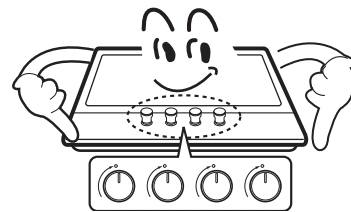

⚠ Caution

- This appliance is intended for domestic cooking only. It is not designed for commercial or industrial purposes.
- Prolonged intensive use of the appliance may call for additional ventilation, for example opening of a window, or increasing the level of mechanical ventilation where present.
- Use heat-resistant pot holders or gloves when handling hot pots and pans.
- Do not let pot holders come near open flames when lifting cookware.
- Take care not to let pot holders or gloves get damp or wet, as this causes heat to transfer through the material quicker with the risk of burning yourself.
- Only ever use the burners after placing pots and pans on them. Do not heat up any empty pots or pans.
- Never use plastic or aluminium foil dishes on the appliance.
- When using other electrical appliances, ensure the cable does not come into contact with the appliance surfaces of the cooking appliance.
- If you have any mechanical parts eg. an artificial heart in your body, consult a doctor before using the appliance.
- When using glass cookware, make sure it is designed for top plate cooking. If the surface is made of glass-cracked, switch off the appliance to avoid defeat electrocution.
- To minimise the possibility of burns, ignition of flammable materials and spillage, turn cookware handles toward the side or center of the top plate without extending over adjacent burners.
- Always turn burner controls off before removing cookware.
- Carefully watch foods being fried at a high flame setting.
- Always heat fat slowly and watch as it heats.
- Foods for frying should be as dry as possible. Frost on frozen foods or moisture on fresh foods can cause hot fat to bubble up and over the sides of the pan.
- Never try to move a pan of hot fat, especially a deep fat fryer. Wait until the fat is completely cool.

Cleaning and Service

Warning

- Never use abrasive or caustic cleaning agents.



- This appliance should only be repaired or serviced by an authorised Service Engineer and only genuine approved spare parts should be used.

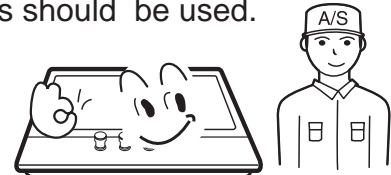

Caution

- Before attempting to clean the appliance, it should be disconnected from the mains and cooled.
- You should not use a steam jet or any other high pressure cleaning equipment to clean the appliance.

Environmental Information

- After installation, please dispose of the packaging with due regard to safety and the environment.
- When disposing of an old appliance, make it unusable, by cutting off the cable.

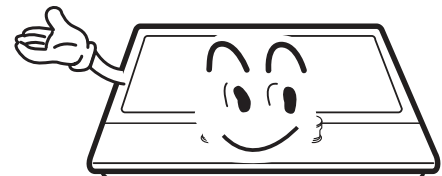

Correct Disposal of This Product (Waste Electrical & Electronic Equipment)

- This marking shown on the product or its literature, indicates that it should not be disposed with other household wastes at the end of its working life. To prevent possible harm to the environment or human health from uncontrolled waste disposal, please separate this from other types of wastes and recycle it responsibly to promote the sustainable reuse of material resources.
- Household users should contact either the retailer where they purchased this product, or their local government office, for details of where and how they can take this item for environmentally safe recycling.
- Business users should contact their supplier and check the terms and conditions of the purchase contract. This product should not be mixed with other commercial wastes for disposal.

Description of the appliance

Model	Top Plate	Dimension (W*D*H)	Ignition device	Gas Connection	Electric supply	Burner Feature	ΣQ_n
MCG601GBL	Glass	600*510*110	Continuous Ignition Type	G1/2 thread	220-240Vac, 50Hz-60Hz, 2W	Wok (1), Semi-rapid (2), Auxiliary (1)	30.4MJ/h

Description of the appliance

Accessories

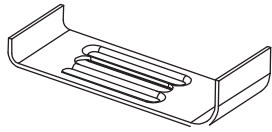

Bracket (4)

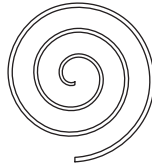

Sponge (4)

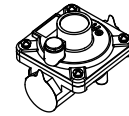

Voltage regulator valve (1)



Injector (4)



Pressure joint(1)



Screw (4)

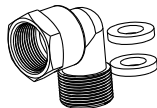

Elbow(1)

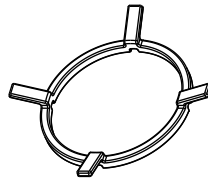

Auxiliary pan support (1)

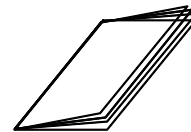

Instruction Manual (1)

How to Use the appliance

The following symbols will appear on the control panel, next to each control handle :

- Black circle: gas off
- 🔥 Large flame: maximum setting
- 🔥 Small flame: minimum setting

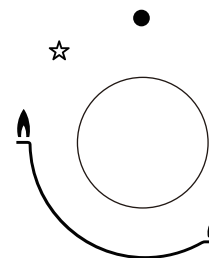

- The minimum setting is at the end of the anti-clockwise rotation of the control handle.
- All operation positions must be selected between the maximum and minimum position.
- The symbol on the control panel, next to the control handle will indicate which burner it operates.

Automatic ignition with flame failure safety device

The appliance is fitted with a flame failure safety device on each burner, which is designed to stop the flow of gas to the burner head in the event of the flame going out.

How to Use the appliance

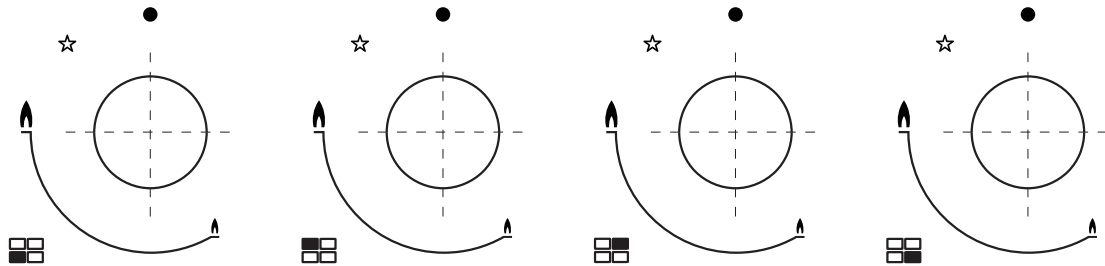

Automatic ignition with flame failure safety device

The appliance is fitted with a flame failure safety device on each burner, which is designed to stop the flow of gas to the burner head in the event of the flame going out.

To ignite a burner:

- o Press in the control knob of the burner that you wish to light and turn it anti-clockwise to the maximum position.
- o If you keep the control knob depressed, the automatic ignition for the burner will operate.
- o You should hold down the control knob for 15 seconds after the flame on the burner has lit. If after 15s the burner has not lit, stop operating the device and open the compartment door and/or wait at least 1 min before attempting a further ignition of the burner.
- o After this 15-second interval, to regulate the flame you should continue turning the control knob anti-clockwise until the flame is at a suitable level. The operating position **MUST** be at a position between the maximum and minimum position.
- o To switch the burner off, turn the control knob fully clockwise to the gas off position.
- o In case of power failure, the burners can be lit by carefully using a match.

Safety and Energy saving advice

- The diameter of the bottom of the pan should correspond to that of the burner.

BURNERS	PANS	
	min.	max.
Triple-Crown	200mm	240mm
Rapid	200mm	240mm
Semi-Rapid	160mm	180mm
Auxiliary	120mm	160mm



■ Do not use cookware that overlaps the edge of the burner.

NO		YES	
	Do not use small diameter cookware on large burners. The flame should never come up the sides of the cookware.	Always use cookware that is suitable for each burner, to avoid wasting gas and discolouring the cookware.	
	Avoid cooking without a lid or with the lid half off -as this wastes energy	Place a lid on the cookware.	
	Do not use a pan with a convex or concave bottom.	Only use pots, saucepans and frying pans with a thick, flat bottom.	
	Do not place cookware on one side of a burner, as it could tip over.	Always place the cookware right over the burners, not to one side.	
	Do not use cookware with a large diameter on the burners near the controls, which when placed on the middle of the burner may touch the controls or be so close to them that they increase the temperature in this area and may cause damage.		
	Never place cookware directly on top of the burner.	Place the cookware on top of the trivet.	
	Do not place anything, eg. flame tamer, asbestos mat, between pan and pan support as serious damage to the appliance may result.		
	Do not use excessive weight and do not hit the cooktop with heavy objects.	Handle cookware carefully when they are on the burner.	



■ It is not recommended to use roasting pans, frying pans or grill stones heated simultaneously on several burners because the resulting heat build-up may damage the appliance.

■ Do not touch the top plate and trivet whilst in use for a certain period after use.











■ As soon as a liquid starts boiling, turn down the flame so that it will barely keep the liquid simmering.

Cleaning and Maintenance



- Cleaning operations must only be carried out when the appliance is completely cool.
- The appliance should be disconnected from your mains supply before commencing any cleaning process.
- Clean the appliance regularly, preferably after each use.
- Abrasive cleaners or sharp objects will damage the appliance surface; you should clean it using water and a little washing up liquid.

Usable	Unusable
 Soft cloth  Neutral Detergent	 Nylon Brush  Metal Brush  Edible Oil  Acidic/Alkali Detergent  Abrasive  Thinner/Benzene

Pan support, Control handles

- Take off the Pan support.
- Clean these and the control handles with a damp cloth, washing up liquid and warm water. For stubborn soiling, soak beforehand.
- Dry everything with a clean soft cloth.

Top plate

- Regularly wipe over the top plate using a soft cloth well wrung-out in warm water to which a little washing up liquid has been added.
- Dry the top plate thoroughly after cleaning.
- Thoroughly remove salty foods or liquids from the hob as soon as possible to avoid the risk of corrosion.
- Stainless steel parts of the appliance may become discoloured over time. This is normal because of the high temperatures. Each time the appliance is used these parts should be cleaned with a product that is suitable for stainless steel.

Cleaning and Maintenance

BURNERS

- Remove the burner lids and Flame Spreaders by pulling them upwards and away from the top plate.
- Soak them in hot water and a little detergent or washing up liqui.
- After cleaning and washing them, wipe and dry them carefully. Make sure that the flame holes are clean and completely dry.
- Wipe the fixed parts of the burner cup with a damp cloth and dry afterwards.
- Gently wipe the ignition device and flame supervision device with a well wrung-out cloth and wipe dry with a clean cloth.
- Before placing the burners back on the top plate, make sure that the injector is not blocked.

■ Re-assemble the Auxiliary, Semi-Rapid, Rapid and Triple-Crown burners as follows :

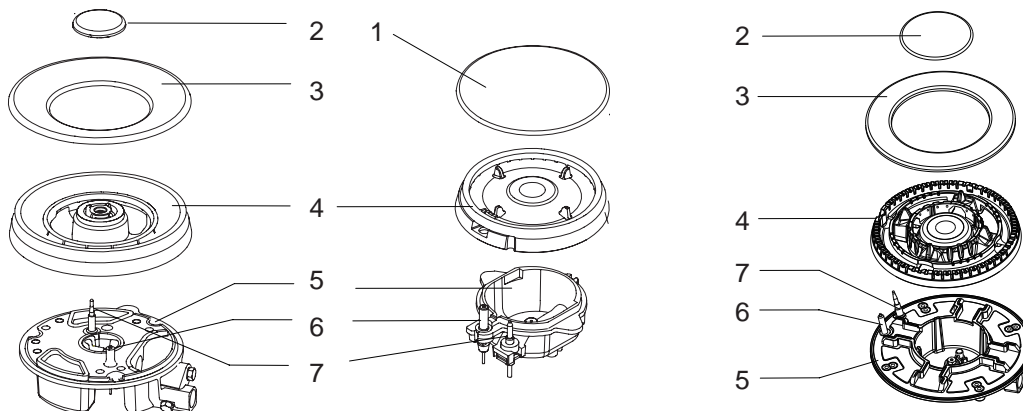

1. Place the flame spreader (4) on to the burner cup (5) so that the ignition device and the flame supervision device extend through their respective holes in the flame spreader. The flame spreader must click into place correctly.
2. Position the burner lid (1,2,3) onto the flame speader (4) so that the retaining pins fit into their respective recesses.



Replace parts in the correct order after cleaning.

- Do not mix up the top and bottom.

- The locating pins must fit exactly into the notches.

Using instructions

Warnings

- Do not modify this appliance.
- This appliance must be installed by an authorised technician or installer.
- Prior to installation, ensure that the local distribution conditions (nature of the gas and gas pressure) and the adjustment of the appliance are compatible.
- The adjustment conditions for this appliance are stated on the label (or data plate).
- This appliance is not connected to a combustion products evacuation device. It should be installed and connected in accordance with current installation regulations. Particular attention should be given to the relevant requirements regarding ventilation.
- Before installing, turn off the gas and electricity supply to the appliance.
- All appliances containing any electrical components must be earthed.
- Ensure that the gas pipe and electrical cable are installed in such a way that they do not touch any parts of the appliance which may become hot.
- Gas pipe or connector shouldn't be bent or blocked by any other appliances.
- Check the dimensions of the appliance as well as the dimensions of the gap to be cut in the kitchen unit.
- The panels located above the work surface, directly next to the appliance, must be made of non-flammable material. Both the stratified surfacing and the glue used to secure it should be heat resistant, to prevent deterioration.
- Turn on appliance tap and light each burners.
Check for a clear blue flame without yellow tipping.
If burners shows any abnormalities check the following :
 - Burner lid on correctly
 - Flame spreader positioned correctly
 - Burner vertically aligned with injector nipple
- A full operational test and a test for possible leakages must be carried out by the fitter after installation.
- The flexible hose shall be fitted in such a way that it cannot come into contact with a moveable part of the housing unit and does not pass through any space susceptible of becoming congested.
- Grease cranes produced at the factory to meet the requirement of all life hob.

Positioning

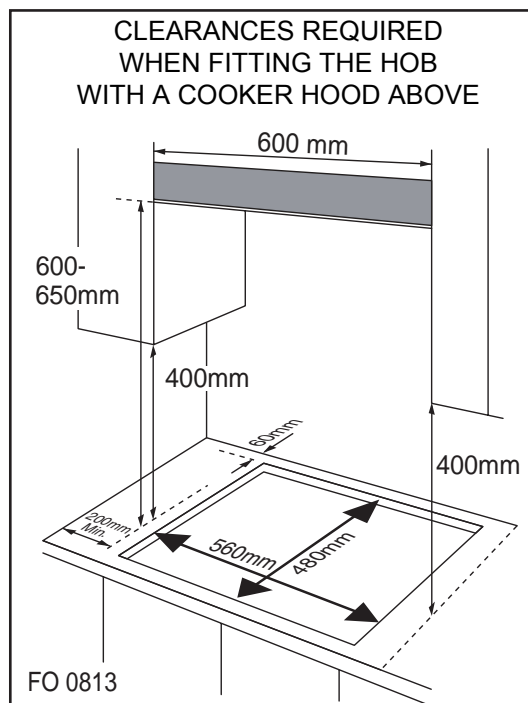

■ **This appliance is to be built into a kitchen unit or 600mm worktop, providing the following minimum distances are allowed;**

- The edges of the hob must be a minimum distance of 60 mm from a side or rear wall.
- 600-650 mm between the highest point of the hob surface (including the burners) and the underside of any horizontal surface directly above it.
- 400 mm between the hob surfaces, providing that the underside of the horizontal surface is in line with the outer edge of the hob. If the underside of the horizontal surface is lower than 400 mm, then it must be at least 50 mm away from the outer edges of the hob.
- 50 mm clearance around the appliance and between the hob surface and any combustible materials.
- You must have a gap of at least 25 mm and at most 74 mm between the underneath of the appliance and any surface that is below it.

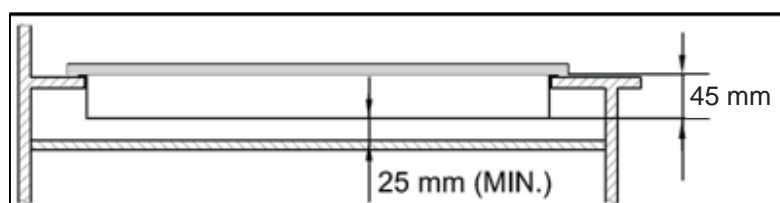

- An oven must have forced ventilation to install a hob above it.
- Check the dimensions of the oven in the installation manual.
- The cut out size must obey the indication.

Installing the appliance

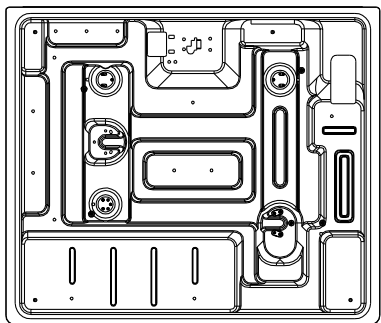
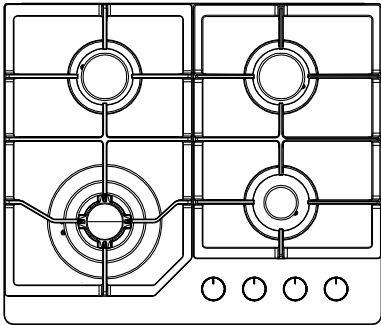

Bottom view

1. Remove the pan supports, the burner lid and flame spreader and carefully turn the appliance upside down and place it on a cushioned mat.

Take care that the Ignition devices and flame supervision devices are not damaged in this operation.

2. Apply the sponge provided around the edge of the appliance.
3. Do not leave a gap in the sealing agent or overlap the thickness.

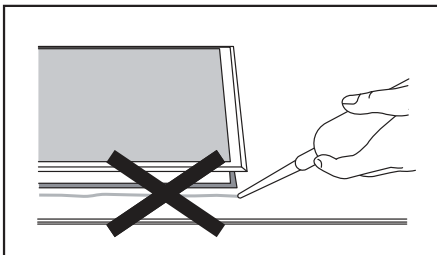

Do not use a silicon sealant to seal the appliance against the aperture.

This will make it difficult to remove the appliance from the aperture in future, particularly if it needs to be serviced.

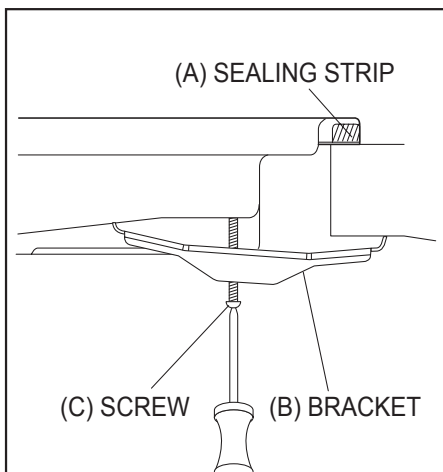

1. Place the bracket (B) over the holes that match the size of the screws. There are one set of screw holes in each corner of the hob (H) .

Slightly tighten a screw (C) through the bracket (B) so that the bracket is attached to the hob, but so that you can still adjust the position.

2. Carefully turn the hob back over and then gently lower it into the aperture hole that you have cut out.
3. On the underneath of the hob, adjust the brackets into a position that is suitable for your worktop. Then fully tighten the screws (C) to secure the hob into position.

Gas Connection



- This appliance must be installed and connected in accordance with installation regulations in force in the country in which the appliance is to be used.
- This appliance is supplied to run on natural gas only and cannot be used on any other type of gas without modification. Conversion for use on LPG and other gases must only be undertaken by a qualified person.



Turn off power for safety and appliance protection. Close middle valve to prevent gas leakage.





Keep away from inflammable materials around appliance. Before work, put on gloves.

CAUTION

Cool off the appliance for a while right after using appliance for your safety because you can get burners by high temperature from the appliances.

Most of the tools that you might need are shown below. Some are optional.

Item	How to use	Pictures
Screw driver	Use for assembly and disassembly of all screws	
Tubing Wrench	Use for assembly and disassembly of tubing to the burner cup	
7mm Vox Driver	Use for assembly and disassembly of injector nozzles.	

Replacement of gas-type fitting

Tool: Open-end wrench

Steps for operation:

A: Disassemble with a wrench the gas-type fittings from main gas tube.

When you disassemble/assemble gas connection, use 2 spanners. One for fixing gas connection elbow, the other for tightening gas hose.

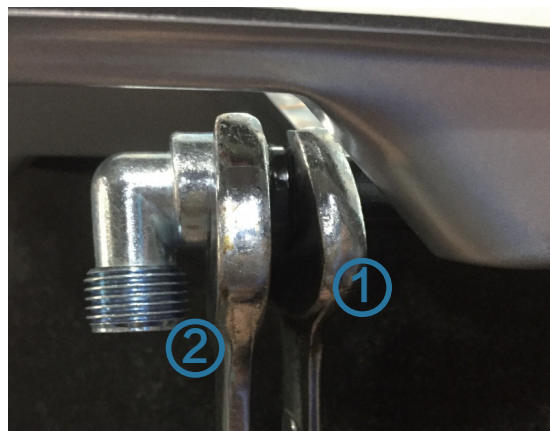

B: Look tightly a replaceable gas-type fitting onto the main gas tube.

Gas Connection

Statutory requirements

This installation must conform with the following:

- Manufacturer's Installation instructions
- Local Gas Fitting Regulations
- Municipal Building Codes
- Refer to AS/NZS 5601.1 for Gas Installations
- S.A.A. Wiring Code
- Local Electrical Regulations
- Any other statutory regulations

Preparing to install

Refer to AS/NZS 5601.1 for piping size details. These built-in cooktops are intended to be inserted in a benchtop cutout. Only an officially authorised technician should connect the appliance. Before you begin, turn off the gas and electricity supply.

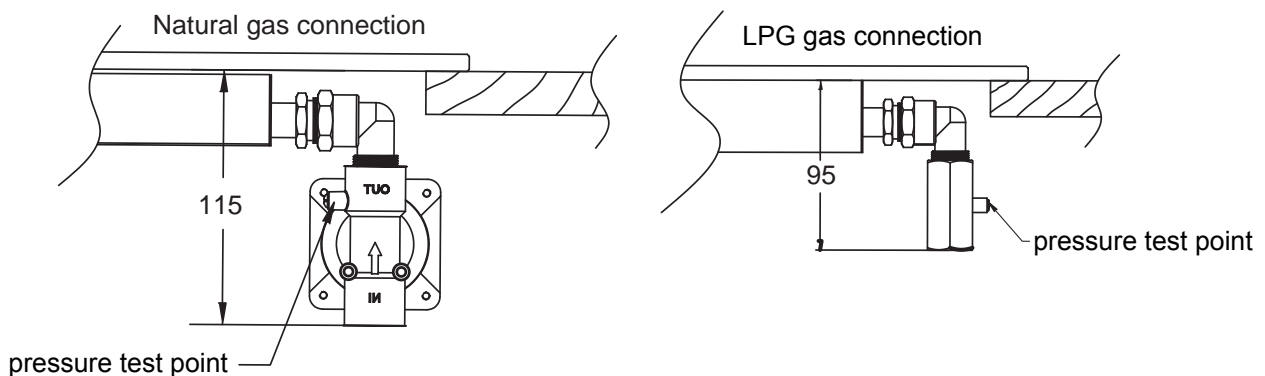

- **A full operational test and a test for possible leakages must be carried out by the fitter after installation.**
- **Access to the whole length of the connection hose must be possible and the gas hose must be replaced before its use before the end of service life (indicated on the hose.)**
- **Before Leaving-Check all connections for gas leaks with soap and water.**
- **DO NOT use a naked flame for detecting leaks. Ignite all burners both individually and concurrently to ensure correct operation of gas valves, burners and ignition. Turn gas taps to low flame position and observe stability of the flame for each burner individually and all together. Adhere the duplicate data plate to an accessible location near the hotplate. When satisfied with the hotplate, please instruct the user on the correct method of operation. In case the appliance fails to operate correctly after all checks have been carried out, refer to the authorised service provider in your area.**

Gas Connection

- Flexible Hose: If installing with a hose assembly, it must comply with AS/NZS 1869, 10mm ID, class B or D, no more than 1.2m long and installed in accordance with AS/NZS 5601.1.
- Ensure that the hose does not contact the hot surfaces of the hotplate, oven, dishwasher or any other appliance that may be installed underneath or next to the hotplate. The hose should not be subjected to abrasion, kinking or permanent deformation and should be able to be inspected along its entire length with the cooktop in the installed position. Unions compatible with the hose fittings must be used and all connections tested for gas leaks. The supply connection point shall be accessible with the appliance installed.
- **WARNING:** Ensure that the hose assembly is restrained from accidental contact with the flue outlet of an underbench oven.

Gas Connection

Install in accordance with relevant gas standards and/or codes of practice applicable.

Connect the elbow fitting to the appliance gas manifold connection, and check that seals between the elbow and manifold connection are in place and in good condition.

- For Natural gas: connect the natural gas appliance regulator (pictured opposite) with integral test point using approved gas thread tape or compound to the elbow fitting.
- For Universal LPG: connect the brass test point adaptor (pictured opposite) using approved gas thread tape or compound to the elbow fitting.

Ensure the supply connection point, test point and natural gas regulator adjustment screw (for Natural gas installation) are accessible for testing and/or adjustment with the hotplate in the installed position.



Natural Gas Regulator



Brass test point adaptor

Where a flexible hose assembly is used, ensure it is approved to AS/NZS 1869, Class B. Any hose assembly used must be restrained from accidental contact with the flue outlet of an under bench oven.

This hose assembly shall be suitable for connection to a fixed consumer piping outlet located as follows:

Hotplates at a point 800 mm to 850 mm above the floor and in the region outside the width of the appliance to a distance of 250 mm.

After connecting to gas, check for leaks using soapy solution, never a naked flame.

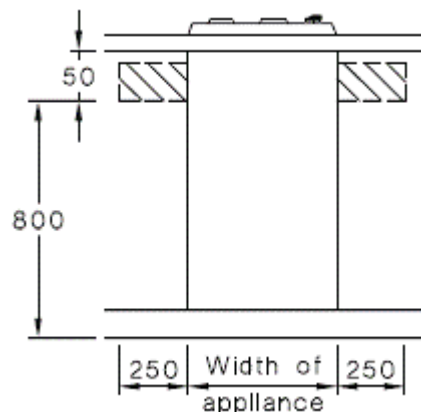

 Inlet connection region for flexible hose

Gas Specification

Model No.	Gas type & pressure	Heat input and orifice size marked(mm)			
		Wok burner	Rapid burner	Semi-rapid	Auxiliary
MCG601GBL		13.5MJ/h	/	6.3MJ/h	4.3MJ/h
	Universal LP Gas 2.75kPa	1.00	/	0.68	0.58
	Natural Gas 1.0kPa	1.72	/	1.15	0.93

Electrical Connection

- This appliance must be earthed.
- This appliance is designed to be connected to a 220-240V, 50Hz-60Hz AC electricity supply.
- The wires in the mains lead are coloured in accordance with the following code;
 - Green/yellow = Earth
 - Blue = Neutral
 - Brown = Live



- The wire which is coloured green and yellow must be connected to the terminal which is marked with the letter E or by the earth symbol.

■ WIRING DIAGRAM

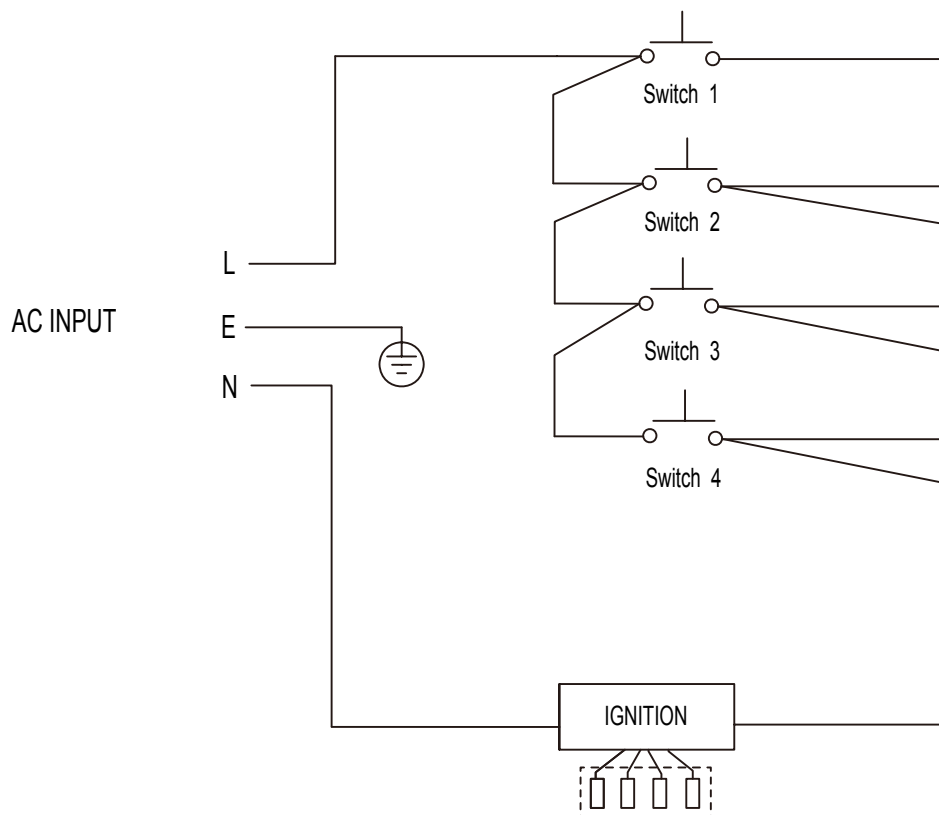

When the power cord is damaged it must be replaced by the manufacturer to produce, customer service agent or similarly qualified personnel.

Gas adjustment



- Take precautions on the operations and adjustments to be carried out when converting from one gas to another.
- All work must be carried out by a qualified technician.
- Before you begin, turn off the gas and electricity supply to the appliance.

1

Change the injector of the burners.

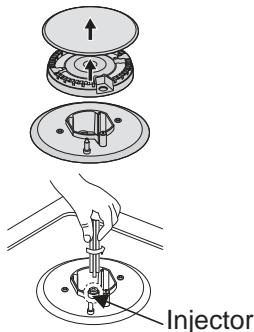

Remove the pan support, Burner lid and Flame spreader.

Unscrew the injector using a 7mm box spanner and replace it with the stipulated injector for new gas supply. Carefully reassemble the all components. After injectors are replaced, it is advisable to strongly tighten the injector in place.

2

Adjustment of minimum level of the flame.

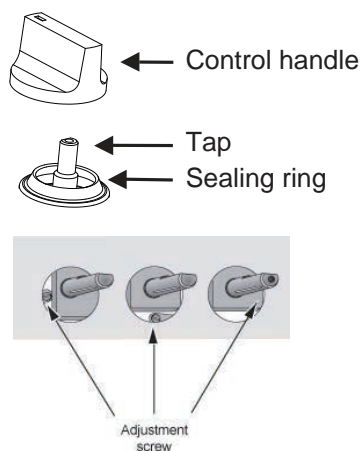

- ① Turn the taps down to minimum.
- ② Remove the knob from the tap and place a small bladed screwdriver in the centre of the tap shaft.
- ③ The correct adjustment is obtained when the flame has a length of about 3 - 4 mm.
 - For butane/ propane gas, the adjusting screw must be tightly screwed in.
 - Refit the control knob.Make sure that the flame does not go out by quickly turning from maximum flow to minimum flow. If it does then remove the control knob and make further adjustments to the gas flow, testing it again once the adjustment has been made.
- ④ Repeat this process for each one of the gas taps.
- ⑤ Attach the ULPG sticker to the cooker, near the gas supply inlet. Cover the Natural label that is factory fitted.



- Do not dismantle the tap shaft: in the event of a malfunction, change the whole tap.
- Before placing the burners back on the top place, make sure that the injector is not blocked.
- A full operational test and a test for possible leakages must be carried out after gas conversion. (such as soap water or gas detector)
- After completing conversion, a qualified technician or installer has to mark "V" on the right gas category to match with the setting in rating plate. Remove the previous setting "V" mark.

Trouble shooting

- Repairs should be performed by a licensed technician only. Improper repair may result in considerable danger to you and others.
- However, some minor problems can be resolved as follows :

Problem	Probable cause	Solution
Not ignited	No Spark.	Check the electricity supply.
	The burner lid is badly assembled.	Assemble the lid correctly.
	The gas supply is closed.	Open the gas supply completely.
Badly ignited	The gas supply is not completely open.	Open the gas supply completely.
	The burner lid is badly assembled.	Assemble the lid correctly.
	The ignition plug is contaminated with alien substance.	Wipe alien substance with a dry cloth.
	The burners are wet.	Dry the burners lids carefully.
	The holes in the flame spreader are clogged.	Clean the flame spreader.
Noise made when combusted and ignited	The burner lid is badly assembled.	Assemble the burner lid correctly.
Flame goes out when in use.	The flame supervision device is contaminated with alien substance.	Clean the flame supervision device.
	Product being cooked has boiled over and extinguished the flame.	Turn off burner knob. Wait one minute and reignite zone.
	A strong draught may have blown the flame out.	Please turn off zone and check cooking area for draught such as open windows. Wait one minute and reignite zone
Yellow Flame	The holes in the flame spreader are clogged.	Clean the flame spreader.
	Different gas is used.	Check the gas used.
Unstable Flame	The burner lid is badly assembled.	Assemble the burner lid correctly.
Gas Smell	Gas leakage	Stop using the product and close the middle valve. Open the window to ventilate. Contact our service centre by using a phone outside.



- If problem is not solved, please contact customer care centre.

