

Midea Ceramic Hob Instruction

MODEL : MC-HV848

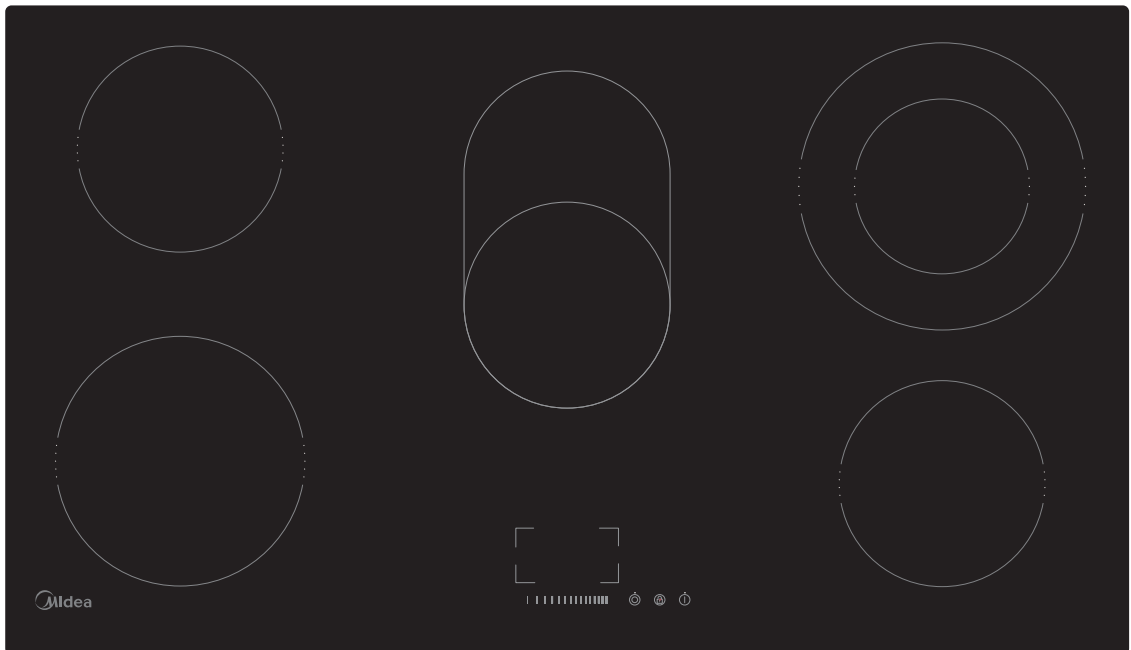

SAVE THESE INSTRUCTIONS CAREFULLY

Read these instructions carefully before using your hob, and keep it carefully. If you follow the instructions, your hob will provide you with many years of good service.

Content

1	Foreword	4
1.1	Safety Warnings	4
1.2	Installation.....	4
	1.2.1 Electrical Shock Hazard	4
	1.2.2 Cut Hazard	4
	1.2.3 Important safety instructions.....	4
1.3	Operation and maintenance.....	5
	1.3.1 Electrical Shock Hazard	5
	1.3.2 Health Hazard	6
	1.3.3 Hot Surface Hazard.....	6
	1.3.4 Cut Hazard	6
	1.3.5 Important safety instructions.....	6
2	Product Introduction.....	8
2.1	Top View.....	8
2.2	Control Panel.....	8
2.3	Product Information	8
2.4	Working Principle	9
2.5	Before using your New Ceramic Hob	9
2.6	Technical Specification	9
3	Operation of Product.....	9
3.1	Touch Controls.....	9
3.2	Choosing the right Cookware	10
3.3	How to use.....	10
	3.3.1 Start cooking	10
	3.3.2 Finish cooking	11
	3.3.3 Locking the Controls	11
	3.3.4 Using the Double zone function.....	12
	3.3.5 Timer control	12
	3.3.6 Over-Temperature Protection	14
	3.3.7 Residual Heat Warning.....	15
	3.3.8 Default working times	15
4	Cooking Guidelines	15
4.1	Cooking Tips	15
	4.1.1 Simmering, cooking rice	15
	4.1.2 Searing steak.....	15
	4.1.3 For stir-frying.....	15
5	Heat Settings	16
6	Care and Cleaning	16
7	Hints and Tips.....	17
8	Installation	18
8.1	Selection of installation equipment	18
8.2	Before locating the fixing brackets.....	19
8.3	Cautions.....	20
8.4	Connecting the hob to the mains power supply.....	20

1 Foreword

1.1 Safety Warnings

Your safety is important to us. Please read this information before using your cooktop.

1.2 Installation

1.2.1 Electrical Shock Hazard

- Disconnect the appliance from the mains electricity supply before carrying out any work or maintenance on it.
- Connection to a good earth wiring system is essential and mandatory.
- Alterations to the domestic wiring system must only be made by a qualified electrician.
- Failure to follow this advice may result in electrical shock or death.

1.2.2 Cut Hazard

- Take care - panel edges are sharp.
- Failure to use caution could result in injury or cuts.

1.2.3 Important safety instructions

- Read these instructions carefully before installing or using this appliance.
- No combustible material or products should be placed on this appliance at any time.
- Please make this information available to the person responsible for installing the appliance as it could reduce your installation costs.
- In order to avoid a hazard, this appliance must be installed according to these instructions for installation.
- This appliance is to be properly installed and earthed only by a suitably qualified person.
- This appliance should be connected to a circuit which incorporates an isolating switch providing full disconnection from the power supply.

- Failure to install the appliance correctly could invalidate any warranty or liability claims.
- This appliance is not intended for use by persons (including children) with reduced physical, sensory or mental capabilities, or lack of experience and knowledge, unless they have been given supervision or instruction concerning use of the appliance by a person responsible for their safety.
- Children shall not play with the appliance. Cleaning and user maintenance shall not be made by children without supervision.
- If the supply cord is damaged, it must be replaced by the manufacturer, its service agent or similarly qualified persons in order to avoid a hazard.
- Warning: If the surface is cracked, switch off the appliance to avoid the possibility of electric shock, for hob surfaces of glass-ceramic or similar material which protect live parts.
- Metallic objects such as knives, forks, spoons and lids should not be placed on the hob surface since they can get hot.
- A steam cleaner is not to be used.
- Do not use a steam cleaner to clean your cooktop.
- The appliance is not intended to be operated by means of an external timer or separate remote-control system.
- WARNING: Danger of fire: do not store items on the cooking surfaces.
- The cooking process has to be supervised. A short term cooking process has to be supervised continuously.
- WARNING: Unattended cooking on a hob with fat or oil can be dangerous and may result in fire. NEVER try to extinguish a fire with water, but switch off the appliance and then cover flame e.g. with a lid or a fire blanket.

1.3 Operation and maintenance

1.3.1 Electrical Shock Hazard

- Do not cook on a broken or cracked cooktop. If the cooktop surface should break or crack, switch the appliance off immediately at the mains power supply (wall switch) and contact a qualified technician.

- Switch the cooktop off at the wall before cleaning or maintenance.
- Failure to follow this advice may result in electrical shock or death.

1.3.2 Health Hazard

- This appliance complies with electromagnetic safety standards.
- However, persons with cardiac pacemakers or other electrical implants (such as insulin pumps) must consult with their doctor or implant manufacturer before using this appliance to make sure that their implants will not be affected by the electromagnetic field.
- Failure to follow this advice may result in death.

1.3.3 Hot Surface Hazard

- During use, accessible parts of this appliance will become hot enough to cause burns.
- Do not let your body, clothing or any item other than suitable cookware contact the Induction glass until the surface is cool.
- Keep children away.
- Handles of saucepans may be hot to touch. Check saucepan handles do not overhang other cooking zones that are on. Keep handles out of reach of children.
- Failure to follow this advice could result in burns and scalds.

1.3.4 Cut Hazard

- The razor-sharp blade of a cooktop scraper is exposed when the safety cover is retracted. Use with extreme care and always store safely and out of reach of children.
- Failure to use caution could result in injury or cuts.

1.3.5 Important safety instructions

- Never leave the appliance unattended when in use. Boilover causes smoking and greasy spillovers that may ignite.
- Never use your appliance as a work or storage surface.
- Never leave any objects or utensils on the appliance.

- Do not place or leave any magnetisable objects (e.g. credit cards, memory cards) or electronic devices (e.g. computers, MP3 players) near the appliance, as they may be affected by its electromagnetic field.
- Never use your appliance for warming or heating the room.
- After use, always turn off the cooking zones and the cooktop as described in this manual (i.e. by using the touch controls). Do not rely on the pan detection feature to turn off the cooking zones when you remove the pans.
- Do not allow children to play with the appliance or sit, stand, or climb on it.
- Do not store items of interest to children in cabinets above the appliance. Children climbing on the cooktop could be seriously injured.
- Do not leave children alone or unattended in the area where the appliance is in use.
- Children or persons with a disability which limits their ability to use the appliance should have a responsible and competent person to instruct them in its use. The instructor should be satisfied that they can use the appliance without danger to themselves or their surroundings.
- Do not repair or replace any part of the appliance unless specifically recommended in the manual. All other servicing should be done by a qualified technician.
- Do not place or drop heavy objects on your cooktop.
- Do not stand on your cooktop.
- Do not use pans with jagged edges or drag pans across the Induction glass surface as this can scratch the glass.
- Do not use scourers or any other harsh abrasive cleaning agents to clean your cooktop, as these can scratch the Induction glass.
- This appliance is intended to be used in household and similar applications such as:
 - staff kitchen areas in shops, offices and other working environments;
 - farm houses;
 - by clients in hotels, motels and other residential type environments;
 - bed and breakfast type environments.

- **WARNING:** The appliance and its accessible parts become hot during use.
- Care should be taken to avoid touching heating elements.
- Children less than 8 years of age shall be kept away unless continuously supervised.
- Keep the appliance and its cord out of reach of children less than 8 years
- After use, switch off the hob element by its control and do not rely on the pan detector.

Congratulations on the purchase of your new Ceramic Hob.

We recommend that you spend some time to read this Instruction / Installation Manual in order to fully understand how to install correctly and operate it. For installation, please read the installation section. Read all the safety instructions carefully before use and keep this Instruction / Installation Manual for future reference.

2 Product Introduction

2.1 Top View

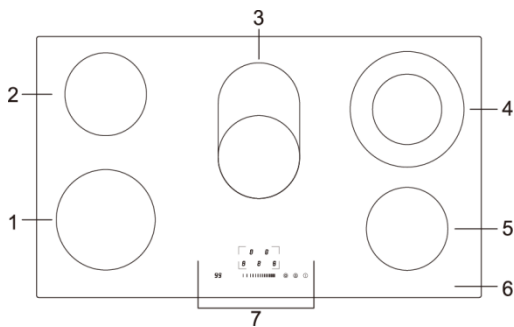

1. Max. 1800 W zone
2. Max. 1200 W zone
3. Max. 1100/ 2000 W zone
4. Max. 1000/ 2200 W zone
5. Max. 1200 W zone
6. Glass plate
7. Control panel

2.2 Control Panel

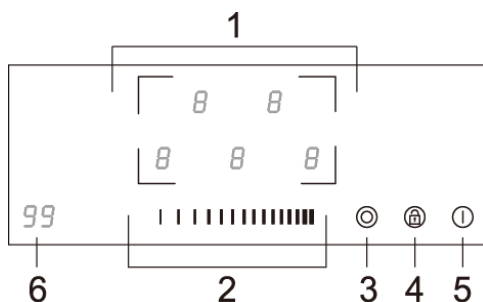

1. Heating zone selection controls
2. Power/Timer slider touch control
3. Dual zone control
4. Keylock control
5. ON/OFF control
6. Timer control

2.3 Product Information

The microcomputer ceramic cooker hob can meet different kinds of cuisine demands because of resistance wire heating, micro-computerized control and multi-power selection, really the optimal choice for modern families.

The ceramic cooker hob centers on customers and adopts personalized design. The hob has safe and reliable performances, making your life comfortable and enabling to fully enjoy the pleasure from life.

2.4 Working Principle

This ceramic cooker hob directly employs resistance wire heating, and adjust the output power by the power regulation with the touch controls.

2.5 Before using your New Ceramic Hob

- Read this guide, taking special note of the 'Safety Warnings' section.
- Remove any protective film that may still be on your ceramic hob.

2.6 Technical Specification

Cooking Hob	MC-HV848
Cooking Zones	5 Zones
Supply Voltage	220-240V~ 50Hz or 60Hz
Installed Electric Power	7600-9200W
Product Size L×W×H(mm)	900X520X55
Building-in Dimensions A×B (mm)	875X495

Weight and Dimensions are approximate. Because we continually strive to improve our products we may change specifications and designs without prior notice.

3 Operation of Product

3.1 Touch Controls

- The controls respond to touch, so you don't need to apply any pressure.
- Use the ball of your finger, not its tip.
- You will hear a beep each time a touch is registered.
- Make sure the controls are always clean, dry, and that there is no object (e.g. a utensil or a cloth) covering them. Even a thin film of water may make the controls difficult to operate.

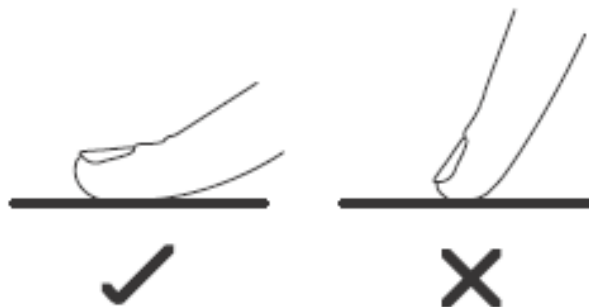

3.2 Choosing the right Cookware

Do not use cookware with jagged edges or a curved base.



Make sure that the base of your pan is smooth, sits flat against the glass, and is the same size as the cooking zone. Always centre your pan on the cooking zone.

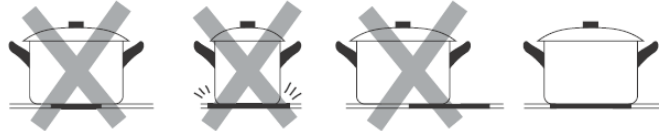



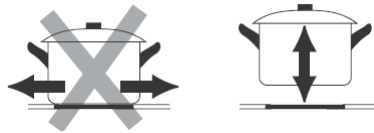

Always lift pans off the ceramic hob – do not slide, or they may scratch the glass.



3.3 How to use

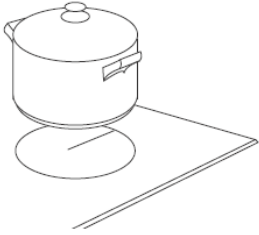

3.3.1 Start cooking

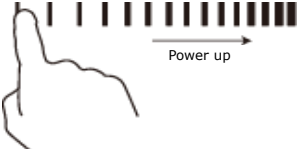
After power on, the buzzer beeps once, all the indicators light up for 1 second then go out, indicating that the ceramic hob has entered the state of standby mode.

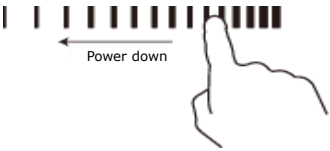
<p>Touch the ON/OFF  control. all the indicators show “-”</p>	
<p>Place a suitable pan on the cooking zone that you wish to use.</p> <ul style="list-style-type: none"> • Make sure the bottom of the pan and the surface of the cooking zone are clean and dry. 	
<p>Touching the heating zone selection control, and a indicator next to the key will flash</p>	
<p>Adjust heat setting by touching the slider control.</p> <ul style="list-style-type: none"> • If you don't choose a heat setting within 1 minute, the ceramic hob will automatically switch off. You will need to start again at step 1. 	

<ul style="list-style-type: none"> You can modify the heat setting at any time during cooking. You can modify the power level from 0 to 9 by the slide control. 	
---	--

3.3.2 Finish cooking

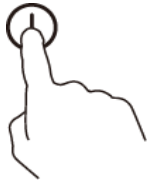
<p>Touching the heating zone selection control that you wish to switch off.</p>	
<p>Turn the cooking zone off by touching the slider to "I". Make sure the display shows "0"</p>	
<p>Turn the whole cooktop off by touching the ON/OFF  control.</p>	





Beware of hot surfaces

"H" will show which cooking zone is hot to touch. It will disappear when the surface has cooled down to a safe temperature. It can also be used as an energy saving function if you want to heat further pans, use the hotplate that is still hot.





3.3.3 Locking the Controls

- You can lock the controls to prevent unintended use (for example children accidentally turning the cooking zones on).
- When the controls are locked, all the controls except the ON/OFF control are disabled.

To lock the controls	
Touch the lock  control	The timer indicator will show "Lo"
To unlock the controls	
Make sure the ceramic hob is turned on Touch and hold the lock control  for a while.	



When the hob is in the lock mode, all the controls are disable except the ON/OFF  , you can always turn the ceramic hob off with the ON/OFF  control in an emergency, but you shall unlock the hob first in the next operation.

3.3.4 Using the Double zone function

- The function only work in 3# and 4# cooking zone
- The dual cooking zone has two cooking areas that you can use a central section and an outer section. You can use the central section **(A)** independently or both sections **(B)** at once.

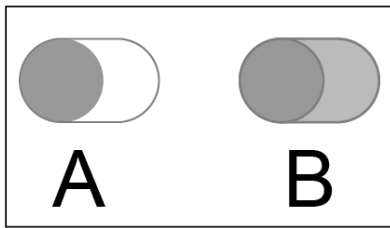

Zone 3#

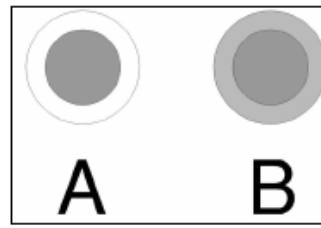

Zone 4#

Activate the Double zone	
Press the heating zone selection control of the double loop heating zone (e.g. 6,)	
The power level indicator flash, then press "⊙", after 5 seconds, the indicator stop flash, the double loop function is activate, and power level shows "6" and "=" alternately.	
Deactivate the Double zone	
Press the heating zone selection control of the double loop heating zone, the power level indicator flash.	
Press "⊙", the double loop function will be cancelled, and power level return to "6" .	

Note:

1. The double loop is available only in 3# and 4# cooking zones
2. You can select the function from level 1 to level 9.
3. You can active the Dual zone only when the 3#or 4# cooking zone is selected.





3.3.5 Timer control

You can use the timer in two different ways:



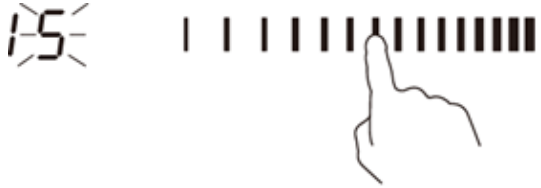

- a) You can use it as a minute minder. In this case, the timer will not turn any cooking zone off when the set time is up.
- b) You can set it to turn one or more cooking zones off after the set time is up.
 - The timer of maximum is 99 minutes



a) Using the Timer as a Minute Minder

If you are not selecting any cooking zone

<p>Make sure the cooktop is turned on. Note: you can use the minute minder even if you're not selecting any cooking zone. Touch the timer control, the "10" will show in the timer display. and the "0" flashes</p>	
<p>Set the time by touching the slider control. (e.g. 5)</p>	
<p>Touch timer control again, the "1" will flash.</p>	
<p>Set the time by touching the slider control (e.g.9), now the timer you set is 95 minutes. When the time is set, it will begin to count down immediately. The display will show the remaining time</p>	
<p>Buzzer will beep for 30 seconds and the timer indicator shows "- -" when the setting time finished.</p>	

b) Setting the timer to turn one or more cooking zone off

Set one zone	
<p>Touching the heating zone selection control that you want to set the timer for.</p>	
<p>Touch timer control , the "10" will show in the timer display. and the "0" flashes.</p>	
<p>Set the time by touching the slider control. (e.g. 5)</p>	
<p>Touch timer control again, the "1" will flash.</p>	

<p>set the time by touching the slider control (e.g.9), now the timer you set is 95 minutes.</p>	
<p>When the time is set, it will begin to count down immediately. The display will show the remaining time When cooking timer expires, the corresponding cooking zone will be switched off automatically. The display will show "H" which means hot;</p>	

Setting the timer to turn more than one cooking zones off

- a). If more than one heating zone use this function, the timer indicator will show the lowest time.
(e.g. zone 1# setting time of 5 minutes, zone 2# setting time of 15 minutes, the timer indicator shows "5".)
NOTE: The red dot next to power level indicator will flash.

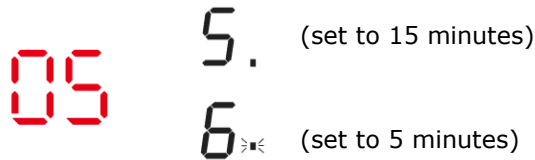

- b). Once the countdown timer expires, the corresponding zone will switch off. Then it will show the new min. timer and the dot of corresponding zone will flash.



- c). When cooking timer expires, the corresponding cooking zone will be switch off automatically.



Note:

- a) The red dot next to power level indicator will illuminate indicating that zone is selected.



- b) you want to change the time after the timer is set, you have to start from step 1.

3.3.6 Over-Temperature Protection

A temperature sensor equipped can monitor the temperature inside the ceramic hob. When an excessive temperature is monitored, the ceramic hob will stop operation automatically.

3.3.7 Residual Heat Warning

When the hob has been operating for some time, there will be some residual heat. The letter " H " appears to warn you to keep away from it.

3.3.8 Default working times

Another safety feature of the hob is automatic shutdown. This occurs whenever you forget to switch off a cooking zone. The default shutdown times are shown in the table below:

Power level	1	2	3	4	5	6	7	8	9
Default working timer (hour)	8	8	8	4	4	4	2	2	2

4 Cooking Guidelines



Take care when frying as the oil and fat heat up very quickly, particularly if you're using Power Boost. At extremely high temperatures oil and fat will ignite spontaneously and this presents a serious fire risk.

4.1 Cooking Tips

- When food comes to the boil, reduce the power setting.
- Using a lid will reduce cooking times and save energy by retaining the heat.
- Minimize the amount of liquid or fat to reduce cooking times.
- Start cooking on a high setting and reduce the setting when the food has heated through.

4.1.1 Simmering, cooking rice

- Simmering occurs below boiling point, at around 85°C, when bubbles are just rising occasionally to the surface of the cooking liquid. It is the key to delicious soups and tender stews because the flavours develop without overcooking the food. You should also cook egg-based and flour thickened sauces below boiling point.
- Some tasks, including cooking rice by the absorption method, may require a setting higher than the lowest setting to ensure the food is cooked properly in the time recommended.

4.1.2 Searing steak

To cook juicy flavorsome steaks:

1. Stand the meat at room temperature for about 20 minutes before cooking.
2. Heat up a heavy-based frying pan.
3. Brush both sides of the steak with oil. Drizzle a small amount of oil into the hot pan and then lower the meat onto the hot pan.
4. Turn the steak only once during cooking. The exact cooking time will depend on the thickness of the steak and how cooked you want it. Times may vary from about 2 – 8 minutes per side. Press the steak to gauge how cooked it is – the firmer it feels the more 'well done' it will be.
5. Leave the steak to rest on a warm plate for a few minutes to allow it to relax and become tender before serving.

4.1.3 For stir-frying

1. Choose an ceramic compatible flat-based wok or a large frying pan.
2. Have all the ingredients and equipment ready. Stir-frying should be quick. If cooking large quantities, cook the food in several smaller batches.

3. Preheat the pan briefly and add two tablespoons of oil.
4. Cook any meat first, put it aside and keep warm.
5. Stir-fry the vegetables. When they are hot but still crisp, turn the cooking zone to a lower setting, return the meat to the pan and add your sauce.
6. Stir the ingredients gently to make sure they are heated through.
7. Serve immediately.

5 Heat Settings

The settings below are guidelines only. The exact setting will depend on several factors, including your cookware and the amount you are cooking. Experiment with the Ceramic hob to find the settings that best suit you.

Heat setting	Suitability
1 - 2	<ul style="list-style-type: none"> • delicate warming for small amounts of food • melting chocolate, butter, and foods that burn quickly • gentle simmering • slow warming
3 - 4	<ul style="list-style-type: none"> • reheating • rapid simmering • cooking rice
5 - 6	<ul style="list-style-type: none"> • pancakes
7 - 8	<ul style="list-style-type: none"> • sautéing • cooking pasta
9	<ul style="list-style-type: none"> • stir-frying • searing • bringing soup to the boil • boiling water

6 Care and Cleaning

What?	How?	Important!
Everyday soiling on glass (fingerprints, marks, stains left by food or non-sugary spillovers on the glass)	<ol style="list-style-type: none"> 1. Switch the power to the cooktop off. 2. Apply a cooktop cleaner while the glass is still warm (but not hot!) 3. Rinse and wipe dry with a clean cloth or paper towel. 4. Switch the power to the cooktop back on. 	<ul style="list-style-type: none"> • When the power to the cooktop is switched off, there will be no 'hot surface' indication but the cooking zone may still be hot! Take extreme care. • Heavy-duty scourers, some nylon scourers and harsh/abrasive cleaning agents may scratch the glass. Always read the label to check if your cleaner or scourer is suitable. • Never leave cleaning residue on the cooktop: the glass may become stained.

Boilovers, melts, and hot sugary spills on the glass	<p>Remove these immediately with a fish slice, palette knife or razor blade scraper suitable for Ceramic glass cooktops, but beware of hot cooking zone surfaces:</p> <ol style="list-style-type: none"> 1. Switch the power to the cooktop off at the wall. 2. Hold the blade or utensil at a 30° angle and scrape the soiling or spill to a cool area of the cooktop. 3. Clean the soiling or spill up with a dish cloth or paper towel. 4. Follow steps 2 to 4 for 'Everyday soiling on glass' above. 	<ul style="list-style-type: none"> • Remove stains left by melts and sugary food or spillovers as soon as possible. If left to cool on the glass, they may be difficult to remove or even permanently damage the glass surface. • Cut hazard: when the safety cover is retracted, the blade in a scraper is razor-sharp. Use with extreme care and always store safely and out of reach of children.
Spillovers on the touch controls	<ol style="list-style-type: none"> 1. Switch the power to the cooktop off. 2. Soak up the spill 3. Wipe the touch control area with a clean damp sponge or cloth. 4. Wipe the area completely dry with a paper towel. 5. Switch the power to the cooktop back on. 	<ul style="list-style-type: none"> • The cooktop may beep and turn itself off, and the touch controls may not function while there is liquid on them. Make sure you wipe the touch control area dry before turning the cooktop back on.

7 Hints and Tips

Problem	Possible causes	What to do
The cooktop cannot be turned on.	No power.	<p>Make sure the ceramic hob is connected to the power supply and that it is switched on.</p> <p>Check whether there is a power outage in your home or area. If you've checked everything and the problem persists, call a qualified technician.</p>
The touch controls are unresponsive.	The controls are locked.	Unlock the controls. See section 'Using your ceramic cooktop' for instructions.
The touch controls are difficult to operate.	There may be a slight film of water over the controls or you may be using the tip of your finger when touching the controls.	Make sure the touch control area is dry and use the ball of your finger when touching the controls.
The glass is being scratched.	<p>Rough-edged cookware.</p> <p>Unsuitable, abrasive scourer or cleaning products being used.</p>	<p>Use cookware with flat and smooth bases. See 'Choosing the right cookware'.</p> <p>See 'Care and cleaning'.</p>
Some pans make crackling or clicking noises.	This may be caused by the construction of your cookware (layers of different metals vibrating differently).	This is normal for cookware and does not indicate a fault.

8 Installation

8.1 Selection of installation equipment

Cut out the work surface according to the sizes shown in the drawing.

For the purpose of installation and use, a minimum of 5 cm space shall be preserved around the hole. Be sure the thickness of the work surface is at least 30mm. Please select heat-resistant and insulated work surface material (Wood and similar fibrous or hygroscopic material shall not be used as work surface material unless impregnated) to avoid the electrical shock and larger deformation caused by the heat radiation from the hotplate. As shown below:



Note: The safety distance between the sides of the hob and the inner surfaces of the worktop should be at least 3mm.

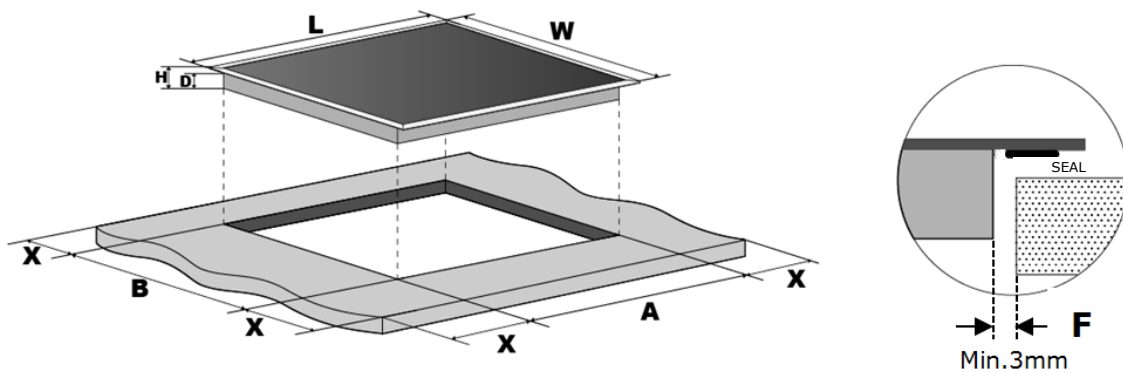

L(mm)	W(mm)	H(mm)	D(mm)	A(mm)	B(mm)	X(mm)	F(mm)
900	520	55	51	875+4 +1	495+4 +1	50 mini	3 mini

Under any circumstances, make sure the ceramic cooker hob is well ventilated and the air inlet and outlet are not blocked. Ensure the ceramic cooker hob is in good work state. As shown below



Note: The safety distance between the hotplate and the cupboard above the hotplate should be at least 760mm.

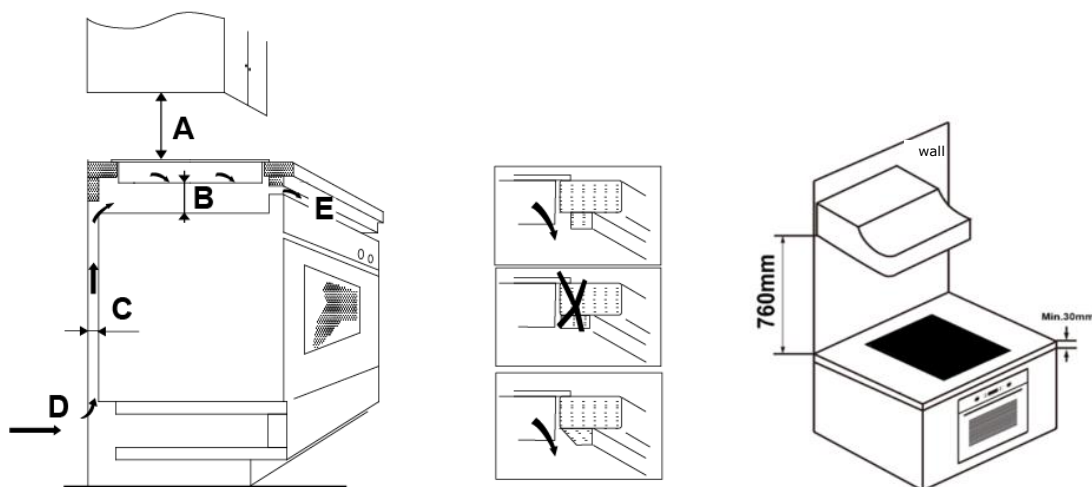

A(mm)	B(mm)	C(mm)	D	E
760	50 mini	20 mini	Air intake	Air exit 5mm

WARNING: Ensuring Adequate Ventilation

Make sure the ceramic hob is well ventilated and that air inlet and outlet are not blocked. In order to avoid accidental touch with the overheating bottom of the hob, or getting unexpected electric shock during working, it is necessary to put a wooden insert, fixed by screws, at a minimum distance of 50mm from the bottom of the hob. Follow the requirements below.

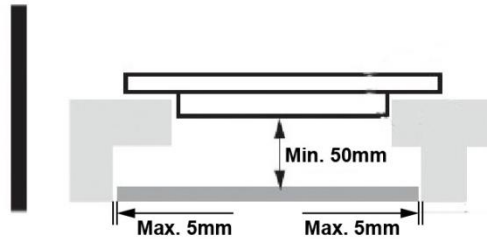

There are ventilation holes around outside of the hob. YOU MUST ensure these holes are not blocked by the worktop when you put the hob into position.



- Be aware that the glue that join the plastic or wooden material to the furniture, has to resist to temperature not below 150°C, to avoid the unstuck of the paneling.
- The rear wall, adjacent and surrounding surfaces must therefore be able to withstand an temperature of 90°C.

8.2 Before locating the fixing brackets

The unit should be placed on a stable, smooth surface (use the packaging). Do not apply force onto the controls protruding from the hob.

Fix the hob on the work surface by screw four brackets on the bottom of hob (see picture) after installation.

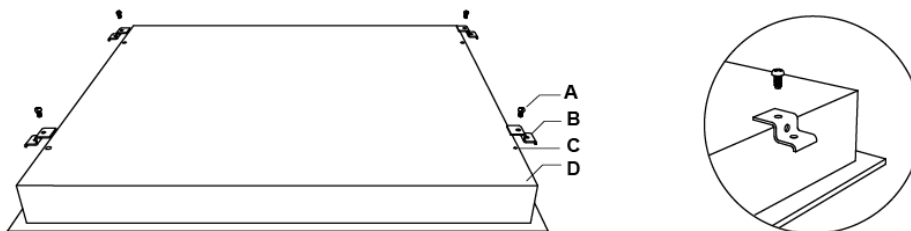

A	B	C	D
screw	bracket	Screw hole	base

Adjust the bracket position to suit for different work surface's thickness.

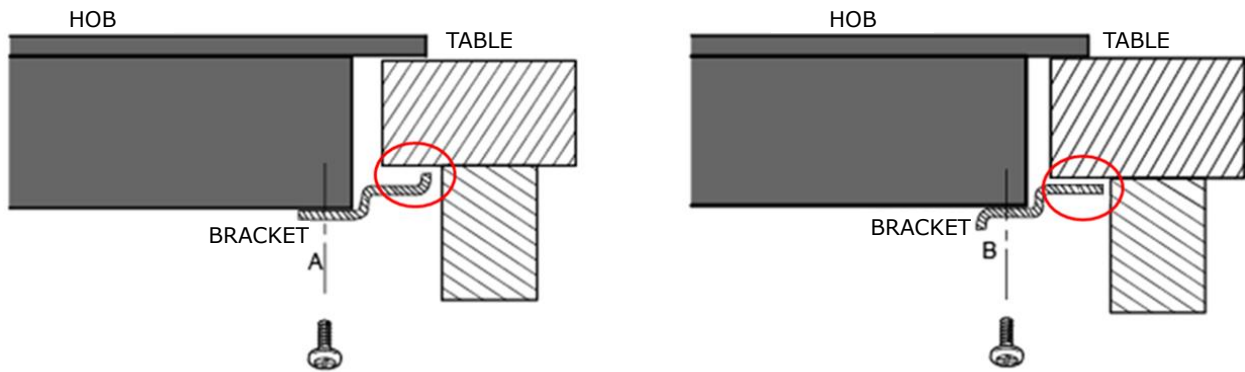

Under any circumstances, the brackets cannot touch with the inner surfaces of the worktop after installation (see picture).

8.3 Cautions

1. The ceramic cooker hob must be installed by qualified personnel or technicians. We have professionals at your service. Please never conduct the operation by yourself.
2. The ceramic cooker hob shall not be mounted to cooling equipment, dishwashers and rotary dryers.
3. The ceramic cooker hob shall be installed such that better heat radiation can be ensured to enhance its reliability.
4. The wall and induced heating zone above the work surface shall withstand heat.
5. To avoid any damage, the sandwich layer and adhesive must be resistant to heat.
6. A steam cleaner is not to be used.

8.4 Connecting the hob to the mains power supply

The power supply should be connected in compliance with the relevant standard, or a single-pole circuit breaker. The method of connection is shown below.

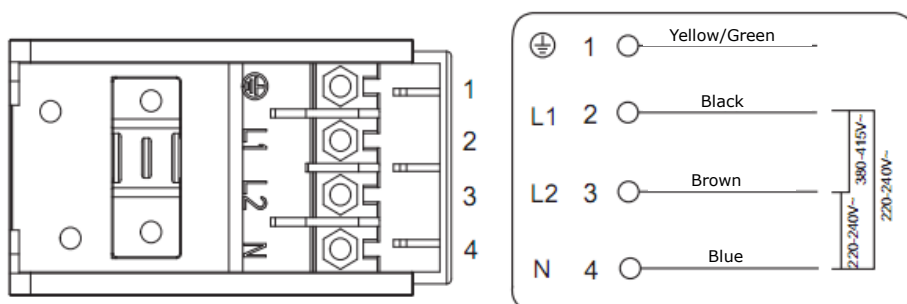

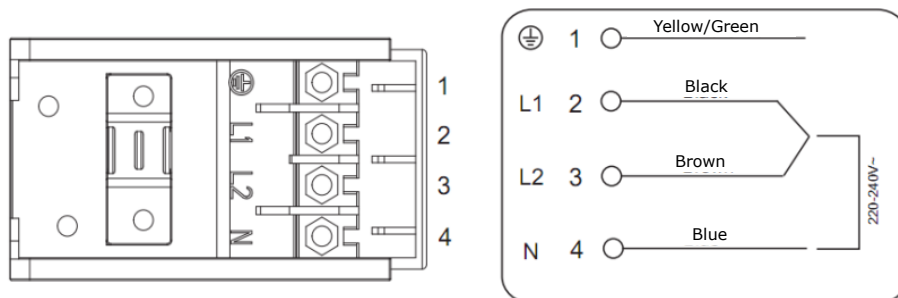

1. If the cable is damaged or needs replacing, this should be done by an after-sales technician using the proper tools, so as to avoid any accidents.
2. If the appliance is being connected directly to the mains supply, an omnipolar circuit breaker must be installed with a minimum gap of 3mm between the contacts.
3. The installer must ensure that the correct electrical connection has been made and that it complies with safety regulations.
4. The cable must not be bent or compressed.
5. The cable must be checked regularly and only replaced by a properly qualified person.
6. The installer must use the H05GG-F power cord.



The bottom surface and the power cord of the hob are not accessible after installation.

	<p>This appliance is labeled in compliance with European directive 2012/19/EU for Waste Electrical and Electronic Equipment (WEEE). By ensuring that this appliance is disposed of correctly, you will help prevent any possible damage to the environment and to human health, which might otherwise be caused if it were disposed of in the wrong way.</p> <p>The symbol on the product indicates that it may not be treated as normal household waste. It should be taken to a collection point for the recycling of electrical and electronic goods.</p> <p>This appliance requires specialist waste disposal. For further information regarding the treatment, recover and recycling of this product please contact your local council, your household waste disposal service, or the shop where you purchased it.</p> <p>For more detailed information about treatment, recovery and recycling of this product, please contact your local city office, your household waste disposal service or the shop where you purchased the product.</p>
--	---

DISPOSAL: Do not dispose this product as unsorted municipal waste. Collection of such waste separately for special treatment is necessary.

目录

1	前言	4
1.1	安全警告	4
1.2	安装	4
1.2.1	触电危险	4
1.2.2	割伤危险	4
1.2.3	重要安全说明	4
1.3	操作和维护	5
1.3.1	触电危险	5
1.3.2	健康危害	5
1.3.3	高温表面危害	5
1.3.4	割伤危险	6
1.3.5	重要安全说明	6
2	产品介绍	7
2.1	顶视图	7
2.2	控制面板	7
2.3	产品介绍	7
2.4	工作原理	7
2.5	使用新的电陶炉之前	8
2.6	技术规格	8
3	产品操作	8
3.1	触摸控件	8
3.2	选择合适的炊具	8
3.3	使用方法	9
3.3.1	启动烹煮	9
3.3.2	完成烹饪	10
3.3.3	锁定控件	10
3.3.4	使用双区功能	10
3.3.5	定时器控件	11
3.3.6	过温保护	13
3.3.7	余热警告	14
3.3.8	默认运行时间	14
4	烹饪指导	14
4.1	烹饪技巧	14
4.1.1	文火慢炖与煮饭	14
4.1.2	炙烤牛排	14
4.1.3	爆炒	14
5	加热设置	15
6	清洁保养	15
7	提示与技巧	16
8	安装	16
8.1	设备安装选择	16
8.2	放置固定支架之前	18
8.3	提醒	18
8.4	将电陶炉连接到家用电源	19

1 前言

1.1 安全警告

您的安全对于我们来说至关重要。使用该炉具前请务必阅读说明书。

1.2 安装

1.2.1 触电危险

- 对本产品进行任何操作或维护之前，请将本器具与主电源的连接断开。
- 必须保证将本产品连接到良好的接地系统。
- 只有具有作业资格的电工方可对住房布线系统进行更改。
- 如果不遵守此建议，可能会导致触电或死亡伤害。

1.2.2 割伤危险

- 注意--面板边缘十分锋利。
- 请谨慎使用，否则可能导致受伤或割伤。

1.2.3 重要安全说明

- 在安装或使用本器具之前，请仔细阅读这些说明。
- 任何时候都不得将易燃材料或产品放置在本器具上。
- 请向负责安装本器具的人员提供安装说明，这样可以降低您的安装成本。
- 为避免危险发生，必须按照说明书安装本器具。
- 只有合适且有资格的人员方可对本器具进行安装及接地操作。
- 应将本器具连接到带有隔离开关的电路中，保证与电源完全断开。
- 如果未能正确安装本器具，可能导致保修或赔偿责任的失效。
- 本设备不适用于身体、感官或精神能力下降或缺乏经验和知识的人（包括儿童），除非负责其安全的人对其使用本设备进行监督或指导。
- 禁止儿童玩弄本产品。未经监督的儿童不得进行清洁和用户维护。
- 如果电源线损坏，必须由生产商、服务代理或类似合格人员更换电源线，以免发生危险。
- 警告：如果保护带电部件的玻璃陶瓷或类似材料的表面发生破裂，请切断器具电源，以防触电。
- 切勿将刀具、叉子、勺子和盖子等金属物品放在炉盘表面上，因为这会导致它们变热。

- 切勿使用蒸汽清洁器。
- 切勿使用蒸汽清洁器对炉具进行清洁。
- 本电器不可使用外部预约器或单独的遥控系统来进行操作。
- 警告：火灾危险：切勿将物品存放在烹饪设备表面上。
- 必须对烹饪过程进行监督。必须对短期的烹饪过程进行持续监督。
- 警告：如果在炉盘上烹饪任何带有脂肪和油的食物时，必须要有人看管，否则可能会造成危险并导致火灾。切勿尝试用水灭火，首先应切断器具电源，然后用盖子或灭火毯盖灭火焰。

1.3 操作和维护

1.3.1 触电危险

- 请勿在破损或破裂的炉具上烹饪。如果炉具表面发生破损或破裂，请立即在主电源（墙壁开关）处切断本器具的电源，并联系有资质的技术人员进行处理。
- 对本炉具进行清洁或维护之前，请通过墙壁上的开关切断电源。
- 如果不遵守此建议，可能会导致触电或死亡伤害。

1.3.2 健康危害

- 本器具符合电磁安全标准。
- 但是，使用心脏起搏器或其他电子植入物（如胰岛素泵）的人员在使用本器具之前必须咨询医生或植入物的制造商，以确保植入物不会受到电磁场的影响。
- 不遵守此建议可能导致死亡。

1.3.3 高温表面危害

- 使用过程中，本器具的可触及部件会变热，进而导致灼伤。
- 在表面冷却之前，请勿让您的身体、衣服或除适当炊具以外的任何物品接触感应玻璃。
- 请勿让儿童靠近。
- 锅具的把手可能很烫，请勿触摸。检查确保锅具的把手不要悬挂于其他工作中的烹饪区之上。确保儿童接触不到把手。
- 不遵守此建议可能导致灼伤和烫伤。

1.3.4 割伤危险

- 保护罩缩回时，炉具刮板锋利的刀片将会暴露在外。使用时请倍加小心，并且一定要安全地存放在儿童接触不到的地方。
- 请谨慎使用，否则可能导致受伤或割伤。

1.3.5 重要安全说明

- 请勿在无人看管的情况下使用本产品。沸溢引起的冒烟和油脂外溢可能会引起燃烧。
- 切勿将本器具用作工作台面或存储表面。
- 切勿将任何物体或器具遗留在本产品上。
- 不要将任何磁性物体（如信用卡和存储卡）或电子设备（如计算机和MP3播放器）放置或遗留在本器具附近，因为它们可能受到其电磁场的影响。
- 切勿将本器具用于温暖或加热房间。
- 使用后，请务必按照本说明的要求，关闭烹饪区和炉具（如：使用触摸控件）。取下平底锅时，请勿依靠锅底检测功能关闭烹饪区域。
- 切勿让儿童玩耍本器具，或坐在、站立或爬上本器具。
- 切勿将儿童感兴趣的物品存放在本器具上方的橱柜中。如果儿童爬上炉具，可能会导致重伤。
- 切勿让儿童单独处于本器具的工作区域或处于无人看管的状态。
- 对于不具备使用本器具能力的儿童或残疾人，应由相关负责人和有能力的人员指导使用。指导人员应确保他们可以使用本器具，并且不会对其自身或周围环境造成危害。
- 除非使用说明中特别建议，否则请勿修理或更换本器具的任何部件。所有其他维修工作应由合格的技术人员完成。
- 切勿在炉具上放置任何重物，或确保任何重物不要跌落到炉具上。
- 切勿站在炉具上。
- 切勿使用带有锯齿状边缘的平底锅或在感应玻璃表面拖拉平底锅，这会刮伤玻璃。
- 切勿使用洗刷器或任何其他硬质研磨清洁剂清洁炉具，这些可能会刮伤感应玻璃。
- 本产品只限于家庭或以下类似场合使用：
 - 商店的员工茶水间、办公室或其他工作场所；
 - 农场；
 - 酒店、汽车旅馆以及其他住宿场所；
 - 住宿和早餐型环境。
- 警告：使用过程中本器具及其可触及部件会变热。

- 应注意避免接触发热元件。
- 除非有人持续监督，否则8岁以下的儿童不得靠近。
- 将电器及其电线放在8岁以下儿童接触不到的地方。
- 使用后，通过控制关闭炉灶元件，不要依赖于平底锅探测器。

恭喜您购得新的电陶炉。

我们建议您能花些时间阅读此说明书/安装手册，以便您完全了解如何正确安装和操作本产品。如需安装，请阅读安装部分。使用前请仔细阅读所有安全说明，并妥善保管此说明书/安装手册以备将来参考。

2 产品介绍

2.1 顶视图

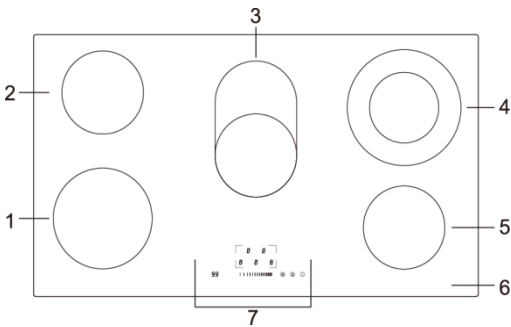

1. 最大 1800 W 区
2. 最大 1200 W 区
3. 最大 1100/2000 W 区
4. 最大 1000/2200 W 区
5. 最大 1200 W 区
6. 玻璃板
7. 控制面板

2.2 控制面板

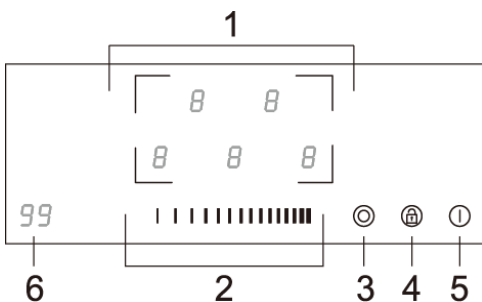

1. 加热区选择控件
2. 功率/定时器滑块触摸控件
3. 双区控件
4. 键锁控件
5. 开/关控件
6. 定时器控件

2.3 产品介绍

微电脑陶瓷炉具采用电阻丝加热，并且可实现微电脑控制和多功率选择，可以满足各种烹饪需求，是现代家庭的最佳选择。陶瓷炊具以客户为中心，采用个性化设计。并且其性能安全可靠，带来舒适体验，让您充分享受生活中的乐趣。

2.4 工作原理

本陶瓷炊具直接采用电阻丝加热，并且可以通过带有触摸控件的功率调节功能调节输出功率。

2.5 使用新的电陶炉之前

- 阅读本指南，特别注意“安全警告”部分。
- 移除电陶炉上的所有保护膜。

2.6 技术规格

烹饪灶台	MC-HV848
烹饪区	5 个区域
电源电压	220-240 V~ 50Hz 或 60Hz
安装的电器系统电源	7600-9200 W
产品尺寸 L×W×H (mm)	900×520×55
嵌入尺寸 A×B (mm)	875×495

重量和尺寸为近似值。由于我们不断努力改进产品，可能会更改产品的规格和设计，恕不另行通知。

3 产品操作

3.1 触摸控件

- 控制键对触摸产生响应，因此您不需要用力按压。
- 请不要使用指尖。
- 每次触摸产生响应时，您会听到蜂鸣声。
- 确保控制键始终是清洁和干燥的，并且不被任何物体（例如器皿或抹布）遮盖。即使溅上些许水也可能使控制键失去响应。

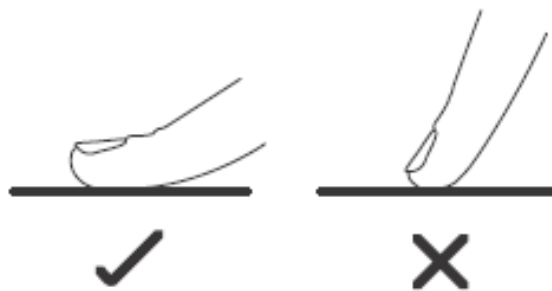

3.2 选择合适的炊具

切勿使用带有锯齿边缘或弯曲底座的炊具。



确保平底锅的底座平滑，可以平放在玻璃上，并且与烹饪区域的尺寸相同。始终将锅放置在烹饪区的中心位置。

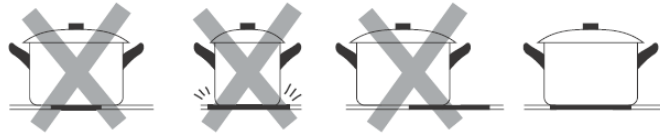

始终将锅具从电陶炉上抬起——不要滑动，否则可能会划伤玻璃。

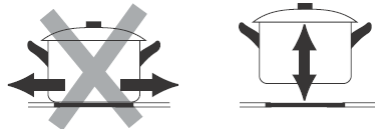



3.3 使用方法

3.3.1 启动烹煮

通电后，蜂鸣器鸣响一次，所有指示灯亮 1 秒后熄灭，表示电陶炉已进入待机状态。

<p>轻按开/关控件①。所有指示器显示“-”</p>	
<p>将适当的平底锅放置在您想要使用的烹饪区域上。</p> <ul style="list-style-type: none"> • 确保锅底和烹饪区表面清洁、干燥。 	
<p>轻按加热区的选择控件，按键旁边的指示灯会闪烁。</p>	
<p>轻按滑块控件来调节加热设置。</p> <ul style="list-style-type: none"> • 如果您在 1 分钟内未选择相应的加热设置，则电陶炉将自动关闭。此时，您需要按照第 1 步重新启动。 • 在烹饪过程中，您可以随时更改加热设置。 • 通过滑块控件，您可以在 0-9 范围内更改功率级。 	

3.3.2 完成烹饪

轻触您希望关闭的加热区选择控件。	
将滑块滑至“1”关闭烹饪区。 确保显示屏上显示“0”。	
通过轻触开/关①控件可关闭整个炉具。	



注意高温表面

烹饪区域因发热而不能触摸时将显示“H”。当表面冷却至安全温度时，显示将消失。如果您想加热更多的锅具，则可以使用仍有余热的电炉，这样可以节约能源。



3.3.3 锁定控件

- 您可以锁定控件以防止意外操作（如：儿童意外打开烹饪区域）。
- 锁定控件后，除开/关控件外的所有其他控件均处于禁用状态。

锁定控件的方法	
轻触锁定控件②	定时器指示灯将显示“Lo”
解锁控件的方法	
确保电陶炉已打开，轻触锁定控件②保持一段时间。	



当灶具处于锁定模式时，除开/关①以外，所有控件都处于禁用状态，您可以在紧急情况下使用开/关控件①来关闭电陶炉，但进行下一项操作前，您应该先对灶具进行解锁。

3.3.4 使用双区功能

- 该功能适用于 3# 和 4# 烹饪区
- 双烹饪区为两个可使用的烹饪区域，即中间部分和外圈部分。您可以单独使用中间部分(A)或同时使用这两个部分(B)

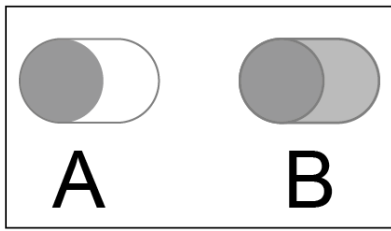

3# 区

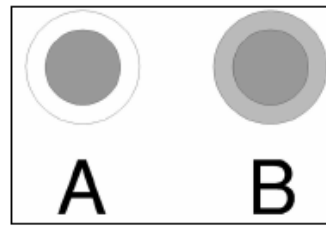

4# 区

激活双区功能	
轻按双环路加热区（例如：6）的加热区选择控件	
功率指示器将闪烁，然后按住“◎”，5 秒后，指示灯停止闪烁，双环路功能激活，功率级交替显示“6”和“=”。	
停用双区功能	
轻按双环路加热区的加热区选择控件，功率指示器会闪烁。	
按“◎”，取消双环路功能，功率级恢复至“6”。	

注意：

1. 此双环路功能仅适用于 3# 和 4# 烹饪区。
2. 加热功能有 1-9 个等级供您选择。
3. 仅选择 3# 或 4# 烹饪区后方可激活双区功能。





3.3.5 定时器控件

定时器有两种使用方法：

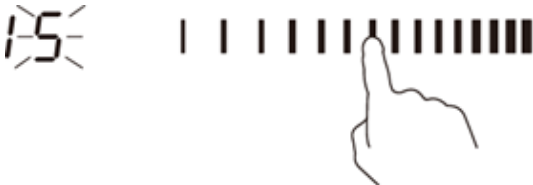

- a) 您可以将它用作分钟提醒。在这种情况下，当设定时间结束时，定时器不会关闭任何烹饪区。
- b) 您可以将其设置为设置时间结束后关闭一个或多个烹饪区域。
 - 定时器的最长定时为 99 分钟



a) 将定时器用作分钟提醒

如果您没有选择任何烹饪区

<p>确保炉具已打开。 注意：即使您没有选择任何烹饪区，也可以使用分钟提醒。 轻按定时器控件，定时器显示屏上会显示“10”，同时“0”闪烁。</p>	
<p>轻按滑块控件对时间进行设置。(例如：5)</p>	
<p>再次轻按定时器控件，“1”将闪烁。</p>	
<p>轻按滑块控件进行时间设置(例如：9)，则您现在的定时器设置为95分钟。 设置时间后，将立即开始倒计时。显示屏显示剩余时间。</p>	
<p>设置时间结束后，蜂鸣器将发出30秒的响声，定时器指示灯显示“--”。</p>	

b) 对定时器进行设置以关闭一个或多个烹饪区

设置一个区域	
<p>轻按您想进行定时器设置的加热区的选择控件。</p>	
<p>轻按定时器控件，定时器显示屏上会显示“10”，同时“0”闪烁。</p>	
<p>轻按滑块控件对时间进行设置。(例如：5)</p>	

再次轻按定时器控件，“1”将闪烁。	
轻按滑块控件进行时间设置(例如:9),则您现在的定时器设置为95分钟。	
设置时间后，将立即开始倒计时。显示屏显示剩余时间。当烹饪定时器时间到，相应烹饪区将自动关闭。显示屏显示“H”，即“烫”的意思；	

对定时器进行设置以关闭一个或多个烹饪区域

- a). 如果多个加热区使用此功能，则定时器指示灯将显示最低时间。(例如，1#区设置时间为5分钟，2#区设置时间为15分钟，则定时器指示灯将显示“5”。)

注意：功率指示器旁边的红点将闪烁。

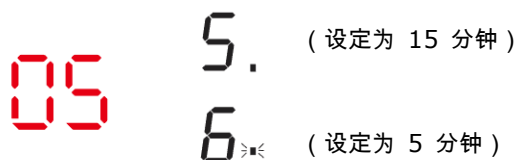

- b). 一旦定时器时间到，相应区域将会关闭。然后它会显示新的定时器最小值，相应区域的点将闪烁。



- c). 当烹饪定时器时间到，相应烹饪区将自动关闭。



注意：

- a) 功率指示器旁边的红点将亮起，表示已选择区域。



- b) 如果要在定时器设置后更改时间，则必须从步骤 1 开始。

3.3.6 过温保护

配备的温度传感器可以监控电陶炉内的温度。监测温度过高时，电陶炉便会自动停止工作。

3.3.7 余热警告

电陶炉运行一段时间后会产余热。显示屏会显示字母“H”警告您远离电陶炉。

3.3.8 默认运行时间

电陶炉的另一个安全特性是自动关机。若您忘记关闭烹饪区，电陶炉会自动关闭。默认关机时间见下表：

功率级	1	2	3	4	5	6	7	8	9
默认运行定时 (小时)	8	8	8	4	4	4	2	2	2

4 烹饪指导



注意油和脂肪在煎炸时受热极快，尤其在增加功率时。极高温下油和脂肪会发生自燃，存在重大火灾风险。

4.1 烹饪技巧

- 食物沸腾时，请下调温度设置。
- 盖上盖子可以减少烹饪时间，也可以通过保温来节约能源。
- 尽可能减少液体或脂肪用量来减少烹饪时间。
- 开始烹饪时设置较高温度，食物受热后调低温度设置。

4.1.1 文火慢炖与煮饭

- 文火慢炖的温度在沸点以下，约 85°C，容器中的液面会偶尔冒出气泡。文火慢炖是汤鲜菜嫩的关键，因为它的味道不是来自于过度烹饪。您在烹饪加鸡蛋的或勾芡增稠的酱汁时也应设置温度在沸点以下。
- 某些烹饪任务，如使用提前浸泡法煮饭，可能需要将温度在比最低温度较高时才能保证食物在一定时间内煮熟。

4.1.2 炙烤牛排

烹饪美味多汁的牛排：

1. 先将牛肉在室温下放置约 20 分钟再烹饪。
2. 将厚底煎锅加热。
3. 牛排两面各刷一层油。往热锅里稍微放一点油，再将牛肉放进锅中。
4. 烹饪过程中仅可翻动牛排一次。但确切的烹饪时间则取决于牛排的厚度和您想要的成熟度。每侧的烹调时间为 2-8 分钟不等。按压牛排可以确定成熟度，牛排越硬说明成熟度越高。
5. 将牛排置于温暖的盘子中几分钟，使其在上桌前变得松弛、柔嫩。

4.1.3 爆炒

1. 选择一个陶制的兼容平底锅或一个大煎锅。
2. 准备好所有原料和设备。爆炒速度要快。若要食物量多，可分批进行烹饪。
3. 短暂预热平底锅后加入两汤匙油。
4. 先将肉炒熟，然后将其放在一边并保温。
5. 接下来爆炒蔬菜。在蔬菜变热但仍然发脆的时候，将烹饪区的温度设置调低，再将肉和酱汁加入锅中。
6. 轻轻翻炒原料，确保其充分受热。
7. 即可食用。

5 加热设置

以下设置仅供参考。具体设置取决于多个因素，包括您的炊具和烹饪量。可在电陶炉上不断尝试，寻找最适合您的设置。

加热设置	适用范围
1 - 2	<ul style="list-style-type: none"> • 微加热少量食物 • 融化巧克力、黄油及迅速燃烧的食物 • 文火慢炖 • 缓慢加热
3 - 4	<ul style="list-style-type: none"> • 重新加热 • 快速炖煮 • 煮饭
5 - 6	<ul style="list-style-type: none"> • 薄煎饼
7 - 8	<ul style="list-style-type: none"> • 嫩煎 • 烹任意大利面
9	<ul style="list-style-type: none"> • 爆炒 • 煎 • 将汤煮沸 • 将水烧开

6 清洁保养

污渍种类	清洁方法	重要提示!
玻璃上的日常污渍(玻璃上的指纹、痕迹、食物留下的污点或不含糖的溢出物)	<ol style="list-style-type: none"> 1. 断开炉具电源 2. 趁杯子还热(但不烫!)的时候倒上炉具清洁剂 3. 冲洗后用干净的布或纸巾擦干。 4. 重新打开炉具电源 	<ul style="list-style-type: none"> • 当关闭炉具电源后，显示屏不显示“高温表面”但烹饪区仍可能很烫!请千万小心。 • 重型洗刷器、某些尼龙洗刷器和硬质/研磨性清洁剂可能会划伤玻璃。请务必阅读清洁剂或洗刷器的标签来确定它们是否合适。 • 不要在炉具上留下清洁剂残留:否则可能会使玻璃变色。
玻璃上的沸溢、融化物、热含糖溢出物	<p>立即用适合陶瓷玻璃炉具的煎鱼铲、铲刀或锋利刮刀将其清除，但须小心高温烹饪区的高温表面：</p> <ol style="list-style-type: none"> 1. 断开墙上的炉具电源。 2. 使刀或器具呈 30°角，将污垢或溢出物刮出至炉具的低温区域。 3. 再用抹布或纸巾清理污垢或溢出物。 4. 按照以上步骤 2 到 4 清理“玻璃上的日常污渍”。 	<ul style="list-style-type: none"> • 尽快清除融化物、含糖食物或溢出物留下的污渍。污渍在玻璃上冷却后可能难以去除，甚至会永久性地损坏玻璃表面。 • 割伤危险：保护罩缩回后，刮刀中的刀片十分锋利。使用时请倍加小心，并且一定要安全地存放在儿童接触不到的地方。
触摸控件上的溢出物	<ol style="list-style-type: none"> 1. 断开炉具电源 2. 吸收溢出物 3. 用干净的湿海绵或湿布擦拭触摸控件区。 4. 再用纸巾将该区域完全擦干。 5. 重新打开炉具电源 	<ul style="list-style-type: none"> • 触摸控件上有液体时可能无法工作，炉具会发出蜂鸣声并自动关闭。重新启动炉具之前，请确保将触摸控件区已完全擦干。

7 提示与技巧

问题	可能原因	做法
炉具无法启动。	无电。	确保电陶炉已连接电源且电源已开启。 检查您家中或附近是否停电。若您已检查了所有地方但问题仍然存在，请联系有资质的技术人员。
触摸控件没有反应。	控件已锁定。	解锁控件的方法相关说明请参阅“陶制炉具”一节。
触摸控件很难操作。	控件上可能存在薄薄的水膜，或者您是用指尖触摸控件。	请确保触摸控件区干燥，并用您的手指肚触摸控件。
玻璃被刮花。	边缘粗糙的炊具 使用了不适合的、研磨性洗刷器或清洁产品。	使用平底且光滑的炊具。参阅“选择合适的炊具” 参阅“保养清洁”一节。
某些平底锅会发出劈啪声或碎裂声。	这可能是炊具结构引起的（不同金属层发生不同振动）。	对于炊具来说这是正常现象并非出现故障。

8 安装

8.1 设备安装选择

按图中所示的尺寸裁剪工作面。

为便于安装和使用，开孔周围应至少留有 5 cm 的空间。

确保工作面的厚度至少为 30 mm。请选用耐热、隔热的工作面材料（木料与类似的纤维或吸湿材料不得作为工作表面材料，除非此等材料已浸渍处理），避免因电炉的热辐射引起触电和大幅变形。如下所示：



注意：电陶炉两侧与台面的安全距离至少应为 3 mm。

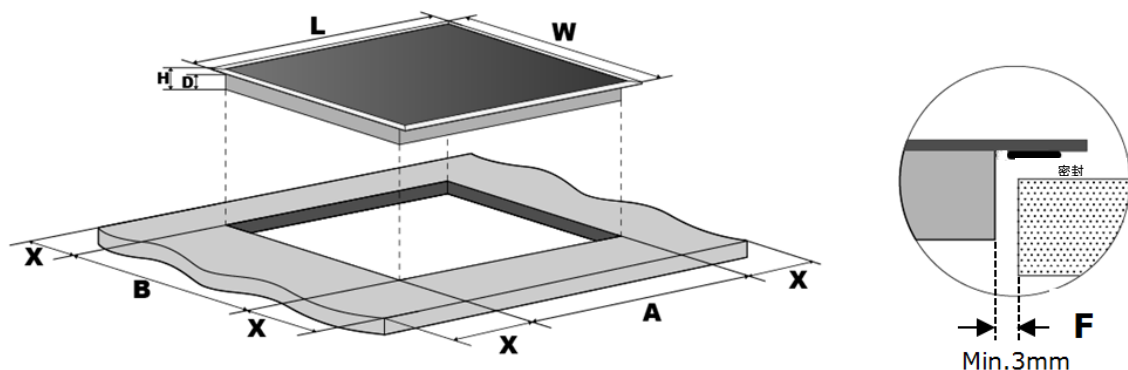

L(mm)	W(mm)	H(mm)	D(mm)	A(mm)	B(mm)	X(mm)	F(mm)
900	520	55	51	875+4 +1	495+4 +1	50(最小值)	3(最小值)

任何情况下都应确保电陶炉通风良好且进出口不被堵塞。同时确保电陶炉运行良好。如下所示



注意：电炉与其上方的橱柜之间的安全距离至少应为 760 mm。

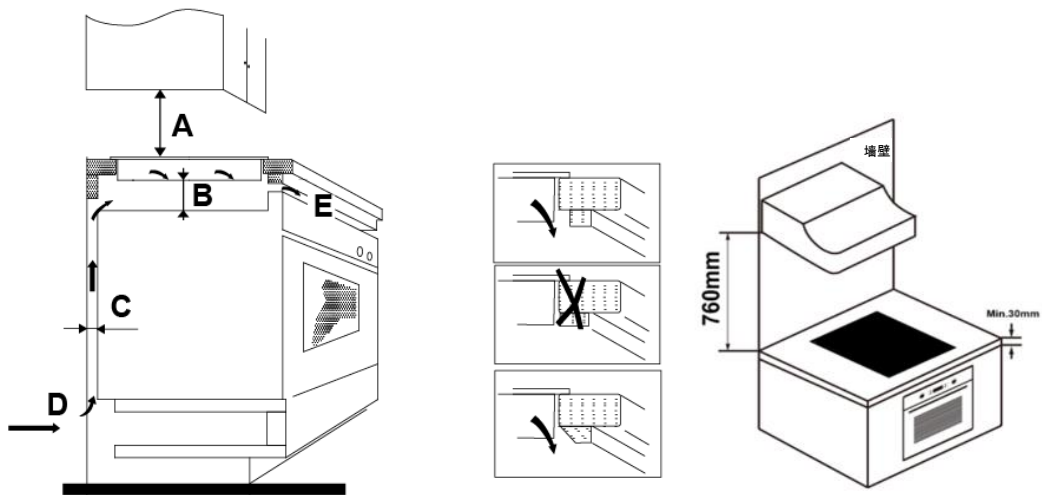

A(mm)	B(mm)	C(mm)	D	E
760	50 (最小值)	20 (最小值)	进风口	出风口 5 mm

警告：确保足量通风

确保电陶炉通风良好且进出风口不被堵塞。为避免意外接触过热的电陶炉或运行中遭到无法预知的电击，必须在电陶炉下方至少 50 mm 处放置一块用螺丝固定的木垫板。要求如下。

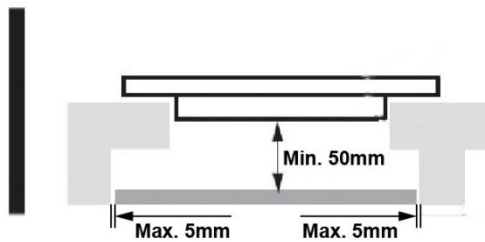

电陶炉外侧有通风孔。您在放置电陶炉时必须确保这些通风孔没有被台面堵住。



- 务必注意，将塑料或木制材料粘合到设备上的胶水必须能够耐受 150°C 以上的温度，以避免镶板脱落。
- 因此，后墙与邻近表面必须能够耐受 90°C 的温度。

8.2 放置固定支架之前

设备应放置在稳定、光滑的表面上（使用包装）。不要按压电陶炉上突出的控件。
安装完成后，拧紧电陶炉底部的四个支架螺丝将电陶炉固定在工作面上（如图）。

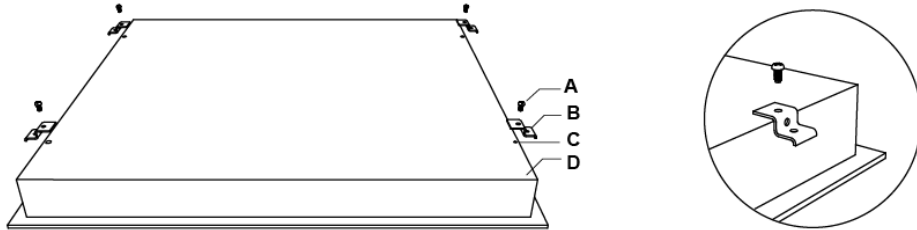

A	B	C	D
螺丝	支架	螺孔	底座

将支架调整到适应工作面厚度的位置上。

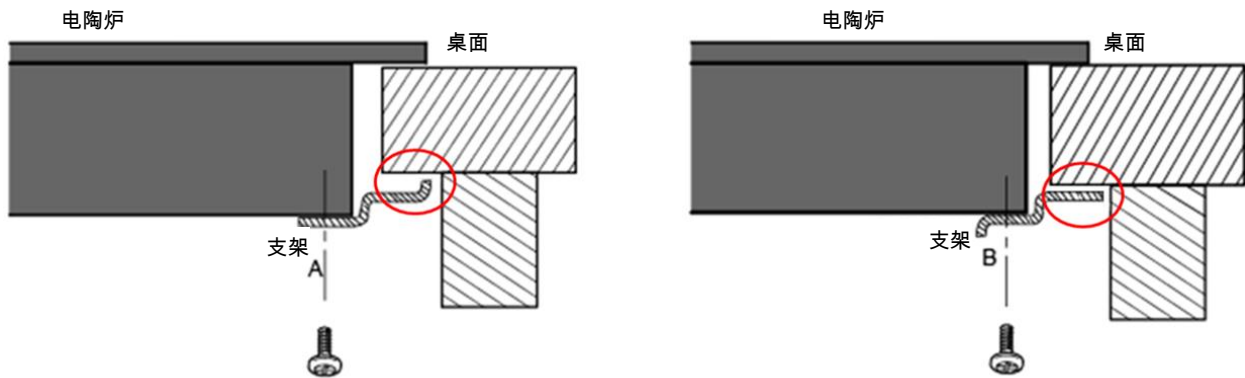

任何情况下，安装好的支架都不会与台面内表面接触（见图）。

8.3 提醒

1. 电陶炉必须由有资质的人员或技术人员进行安装。我们的专业人员随时为您服务。切勿自行操作。
2. 电陶炉不得安装在冷却设备、洗碗机和旋转式烘干机上。
3. 电陶炉的安装应保证更好的热辐射，提高其可靠性。
4. 工作面上方的墙壁和感应加热区应耐高温。
5. 为避免出现任何损伤，夹层和粘合剂必须耐高温。
6. 切勿使用蒸汽清洁器。

8.4 将电陶炉连接到家用电源

电源连接应符合相关标准，或采用单极开关。连接方法如下所示。

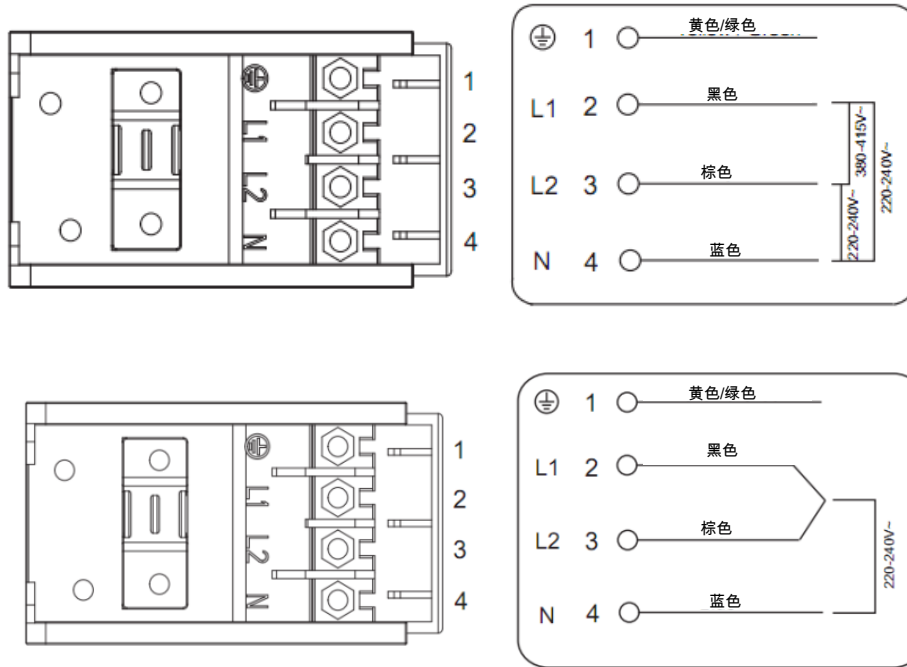

1. 若电线损坏或需要更换，则应由售后技术人员使用适当的工具进行更换以免发生意外。
2. 如果器具与家用电源直接连接，则必须安装一个全极断路器且触点之间的最小间距为 3 mm。
3. 安装人员必须确保电气连接正确无误且符合安全规定。
4. 不得弯曲或挤压电线。
5. 必须定期检查电线，且仅可由有资质的人员进行更换。
6. 安装人员必须使用 H05GG-F 电源线。



电陶炉底面和电源线在安装后不可接触。



处置：请勿将本产品处置为未分类的城市垃圾。有必要单独收集该类垃圾进行特殊处理。

本电器标识符合欧洲 2012/19/EU 报废电子电气设备指令 (WEEE)。通过确保正确处置本电器，您可帮助预防任何对环境和人类健康的可能的损害，反之，如果错误处置该电器，则可能导致对环境和人类健康的可能的损害。

产品上的标志表示不可采用正常的家庭垃圾处理方式处理本产品。应将本产品送至废物收集站回收利用电气和电子产品。

本电器需要专业的废物处理程序。欲知更多有关本产品的处理、召回和回收利用信息，请联系您所在的城市市政委员会、生活垃圾处理服务中心或您购买本产品的店铺。

欲知更多有关本产品的处理、召回和回收利用的详细信息，请联系您所在地的市政府、生活垃圾处理服务中心或您购买本产品的店铺。

