

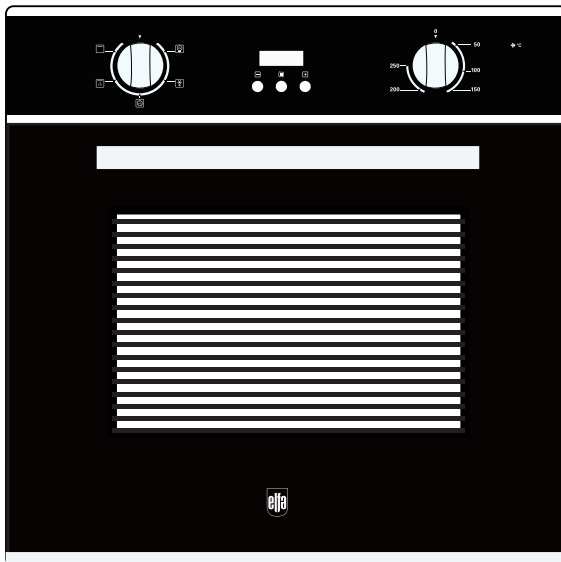

BLFF65E
Built-In Electric Oven
User Manual



ACKNOWLEDGMENT

Thank you for purchasing our product. We hope you enjoy using the many features and benefits it provides. Before using this product please study this entire Instruction Manual carefully. Keep this manual in a safe place for future reference. Ensure that other people using the product are familiar with these instructions as well.

WARNING

- ◆ When the oven is first switched on, it may give off an unpleasant smell. This is due to the bonding agent used for the insulating panels within the oven. This is completely normal, if it does occur, you merely have wait for the smell to clear before putting food into the oven.
- ◆ The appliance and its accessible parts become hot during use.
- ◆ Care should be taken to avoid touching heating elements.
- ◆ Children less than 8 years of age shall be kept away unless continuously supervised.
- ◆ This appliance can be used by children aged from 8 years and above and persons with reduced physical, sensory or mental capabilities or lack of experience and knowledge if they have been given supervision or instruction concerning use of the appliance in a safe way and understand the hazards involved. Children shall not play with the appliance. Cleaning and user maintenance shall not be made by children without supervision.

- ◆ Do not use harsh abrasive cleaners or sharp metal scrapers to clean the glass of the oven. This can scratch the surface and may result in permanent damage to the glass.
- ◆ During use, the appliance becomes very hot. Care should be taken to avoid touching heating elements inside the oven.
- ◆ Do not allow children to go near the oven when it is operating, especially when the grill is on.
- ◆ Ensure that the appliance is switched off before replacing the oven lamp to avoid the possibility of electric shock.
- ◆ The means for disconnection must be incorporated in the fixed wiring in accordance with the wiring specifications.
- ◆ During pyrolytic cleaning, accessible parts may become hotter than normal. Young children should be kept away.
- ◆ Children should be supervised to ensure that they do not play with the appliance.
- ◆ This appliance is not intended for use by persons (including children) with reduced physical, sensory or mental capabilities, or lack of experience and knowledge, unless they have been given supervision or instruction concerning use of the appliance by person responsible for their safety.

SAFETY HINTS

- Do not use the oven unless you are wearing something on your feet. Do not touch the oven with wet or damp hands or feet.
- For oven: Oven door should not be opened often during the cooking period.
- The appliance must be installed by an authorized technician and put into use. The producer is not responsible for any damage that might be caused by defective placement, and installation by unauthorized personnel.
- When the door or drawer of oven is open do not leave anything on it, you may unbalance your appliance or break the door.
- Some parts of appliance may keep its heat for a long time; it is required to wait for it to cool down before touching onto the points that are exposed to the heat directly.
- If you will not use the appliance for a long time, it is advised to plug it off.
- If the supply cord is damaged, it must be replaced by the manufacturer, its service agent or similarly qualified persons in order to avoid a hazard.
- Excess spillage must be removed before cleaning and shall specify which utensils can be left in the oven during cleaning.
- Only use the temperature probe recommended for this oven.
- A steam cleaner is not to be used.

FITTING THE OVEN INTO THE KITCHEN UNIT

Fit the oven into the space provided in the kitchen unit; it may be fitted underneath a work top or into an upright cupboard. Fix the oven in position by screwing into place, using the two fixing holes in the frame. To locate the fixing holes, open the oven door and look inside. To allow adequate ventilation, the measurements and distances adhered to when fixing the oven.

IMPORTANT

If the oven is to work properly, the kitchen housing must be suitable. The panels of the kitchen unit that are next to the oven must be made of a heat resistant material. Ensure that the glues of units that are made of veneered wood can withstand temperatures of at least 120°C. Plastics or glues that cannot withstand such temperatures will melt and deform the unit, once the oven has been lodged inside the units, electrical parts must be completely insulated. This is a legal safety requirement. All guards must be firmly fixed into place so that it is impossible to remove them without using special tools. Remove the back of the kitchen unit to ensure an adequate current of air circulates around the oven. The hob must have a rear gap of at least 45 mm.

DECLARATION OF COMPLIANCE

When you have unpacked the oven, make sure that it has not been damaged in any way. If you have any doubts at all, do not use it: contact a professionally qualified person. Keep packing materials such as plastic bags, polystyrene, or nails out of the reach of children because these are dangerous to children.



PRODUCT DESCRIPTION

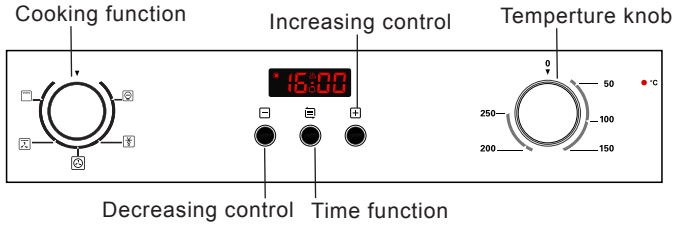



Symbol	Function description
	Oven Lamp: which enables the user to observe the progress of cooking without opening the door.
	Deforst: The circulation of air at room temperature enables quicker thawing of frozen food, (without the use of any heat). It's a gentle but quick way to speed up the defrosting time and thawing of ready-made dishes and cream filled produce etc.
	Convection: An element around the convection fan provides an additional source of heat for convection style cooking. In convection mode the fan automatically comes on to improve air circulation within the oven and creates an even heat for cooking. The temperature can be set within the range of 50-240°C. The default temperature is 180°C.
	Double grill with fan: The radiant heating element and top heating element are working with fan. The temperature can be set within the range of 180-240°C. The default temperature is 210°C.
	Radiant grilling: The inner grill element switches on and off to maintain temperature. The temperature can be set within the range of 180-240°C. The default temperature is 210°C. This is optional function that can be work with rotisserie motor.

OPERATION INSTRUCTIONS



When the oven is first connected to the electrical supply, wait for the display automatically show "12.30", a beep sound once and the "." flash. Ensure the correct time of the day is set before using the oven. please note: that is 24 hour clock, for example 2PM shown as 14.00.

To set the correct time of day

- 1> Press "+" "-" button to adjust the hour setting.
- 2> Press " to confirm the hour setting.
- 3> Press "+" "-" button to adjust the minute setting.
- 4> Press " to confirm the minute setting and the timer will be in standby mode.

Note: If the display does not flash, adjust the time of day by pressing the "+" and "-" buttons at the same time for more than 3 seconds.

Oven On and Off

If the timer is in standby mode, press " for more than 3 seconds, the timer will enter manual mode and the symbol " will light up continuously .

- 1>Set the desired cooking function and the temperature degree.
- 2>Set the time function, then the oven will on.

If you set Dur or End , after cooking ,the oven will automatically turn off.

If you set manual or minute minder, after cooking, bring the cooking function and oven temperature knob to "0" position. Press " "and "+" buttons for more than 3 seconds to return to standby mode.

Time function setting

In manual mode, pressing " can enter the time function setting, the sequence of the function setting is Manual mode - Minute minder-Dur-End-Manual mode. Then selected cooking function and adjust the cook temperature if required.

Manual mode:









In manual mode, only the day's time and the symbol " lights up. The cooking duration has to be controlled by the user.

Notes: In manual mode, to ensure the oven is not left on accidentally, after 5 hours no any button pressed, the timer will flash once a second to warn you the oven will enter standby mode. After a total of 10 hours, the timer will enter standby mode.

When the timer is flashing in manual mode, press any button to reset the timer if you intend to continue using the oven. Or press " "and "+" together for more than 3 seconds to enter standby mode if oven will not be used.

Audible warning time adjustment:

This function can be used to receive audible warning at the completion of the adjusted time period.





- 1>Press " " button to select the minute minder function. The relevant " " ." symbol will flash.
- 2>Use " + " - " button to adjust minute minder. (Refer to the instructions for setting the correct time of day.) Press " " button to confirm, the " " symbol will begin to light continuously. When the " " symbol begins to light continuously, the audible warning time adjustment is done.
- 3>When the time is up, the timer gives an audible warning and the " " symbol begins to flash on the screen. Press any button less than 3 seconds, it will stop the audible warning and the " " symbol disappears on the screen. Audible warning time adjustment is for warning purposes only. Press " " and " + " together for more than 3 seconds to enter standby mode if oven will not be used.

Semi-automatic programming according to cooking period:

This function is used to cook in the desired time range, The food to be cooked are put into the oven.





The oven is adjustment to the desired cooking function and temperature degree.

The maximum setting of cooking period is 10 hours.

- 1>Press " " button until you see " Dur " on the timer screen.(Before setting cooking period.)
- 2>Use " + " - " button to adjust cooking period for the food you wish to cook. (Refer to the instructions for setting the correct time of day .) Press " " button to confirm , the day's time will appear on the screen and the symbols "A" " " will light on the screen. While doing this, the oven will also start to operate.
- 3>At the completion of the set duration, the timer will stop the oven and give an audible warning. Also, the symbol" A" will begin to flash on the screen. After bringing the cooking function and oven temperature knob to "0" position. Pressing any button less than 3 seconds, it will stop the audible warning. Pressing " " for more than 3 seconds set the oven to Manual mode again to use the oven.



Semi-automatic programming according to finishing time:



This function is used to cook according to the desired finishing time. The food to be cooked is put into the oven. The oven is adjusted to the desired cooking function and temperature degree.

- 1>Press " " button until you see " End " on the timer screen.(Before setting finished time).
- 2>Use " + " - " button to adjust finishing time. (Refer to the instructions for setting the correct time of day.)
- 3>Press " " button to confirm, the day's time will appear on the screen and the symbols "A" " " will light on the screen. While doing this, the oven will also start to operate.
- 4>At the completion of the set duration, the timer will stop the oven and give an audible warning. Also, the symbol" A" will begin to flash on the screen. After bringing the cooking function and oven temperature knob to "0" position. Pressing any button less than 3 seconds, it will stop the audible warning. Pressing " " for more than 3 seconds set the oven to Manual mode again to use the oven.

Full-automatic programming:

This function is used to cook after a certain period of time, with a certain duration. The food to be cooked is put into the oven. The oven is adjusted to the desired cooking function. The oven temperature is adjusted to the desired degree depending on the food to be cooked.

First: Press " " button until you see "Dur " on the timer screen. Use " + " - " button to adjust cooking period for the food you wish to cook. Press " " button to confirm, the day 's time will appear on the screen and the symbols "A" will begin to continuously light on the screen.

Second: keep pressing on " " button until you see "End" on the timer screen. When you see "End" on the timer screen, Use " + " - " button to adjust finishing time, Press " " button to confirm, the day's time will appear on the screen and the symbol "A" will begin to continuously light on the screen. The symbol " " disappears until the time cooking starts.

You can set a time which can be up 23.59 hours after the time obtained by adding the cooking period to the day's time.

The oven will start operating at the time calculated by deducting the cooking period from the set finishing time, and will stop at the set finishing time. The timer will give an audible warning and the symbol "A" will begin to flash .After bringing the cooking function and oven temperature knob to"0" position. Pressing any button less than 3 seconds, it will stop the audible warning.

Pressing " " for more than 3 seconds set the oven to Manual mode again to use the oven.

Please note:Once setting full-automatic mode, all the time can not be changed. Change time means cancel automatic programme and enter into corresponding mode. If you need to reset automatic mode, need to stop setting the current mode, to set the automatic mode according to the above steps again.

Specification

1>Long press on"+" or "-" for more than 3 seconds, the date will progressively and rapidly increase or decrease in the rate of 5 seconds.

2>When setting each of the time function, if there is none operation for 5 minutes then it will return to manual mode.

3> When setting each of the time function, pressing on " " for more than 3 seconds can cancel current setting and enter manual mode.

4> During time function setting, pressing on "+and "  " for more than 3 seconds , a beep sounds it can cancel the current time function setting and enter standby mode.

5> We suggest that you run the oven elements for 15 minutes at 200 degrees to burn off any residue from their surfaces.

ACCESSORIES

Wire shelves : For grill dishes, cake pan with items for roasting and grilling.

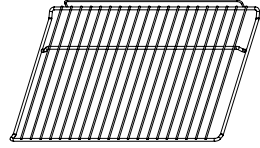

Universal pan: For cooking large quantities of food such as moist cakes, pastries, frozen food etc, or for collecting fat/ spillage and meat juices.

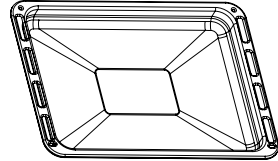

SHELF PLACEMENT WARNING:

To ensure the oven shelves operate safely, correct placement of the shelves between the side rails is imperative. This will ensure that during careful removal of the shelf or tray, hot food items should not slide out.

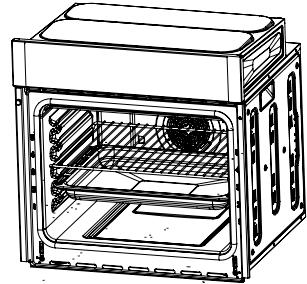

BULB REPLACEMENT

The bulb in the light is a special bulb, and has high temperature resistance (240V~25W).

For replacement, proceed as follows:

- 1>.Disconnect power from the mains outlet or switch off the circuit breaker of the unit's mains outlet.
- 2>.Unscrew the covering glass and replace the bulb with a new one of the same type.
- 3>.Screw the covering glass back in place.

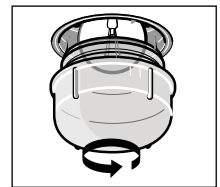

SECURING THE OVEN TO THE CABINET

1. Fit oven into the cabinet recess.
2. Open the oven door.
3. Secure the oven to the kitchen cabinet with two distance holders "A" which fit the holes in the oven frame and fit the two wood screws "B".

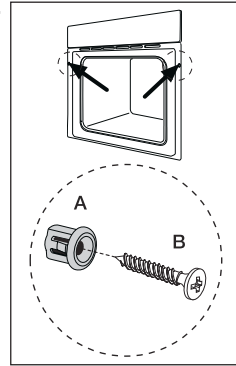

CONNECTION OF THE OVEN

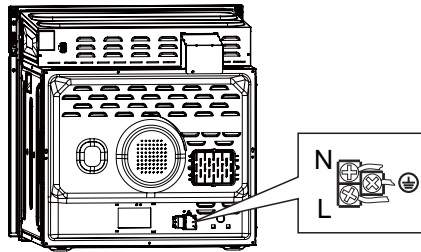

INSTALLATION

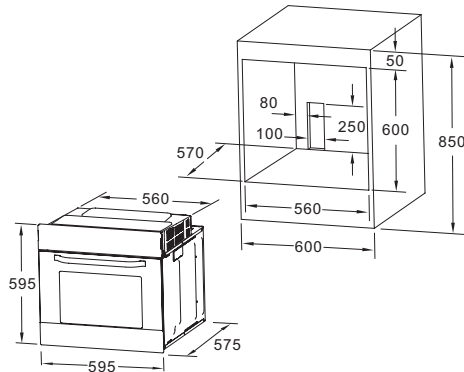

NOTE: The number of accessories included depends on the particular appliance purchased.

CLEANING AND MAINTENANCE

For the sake of good appearance and reliability, keep the unit clean. The modern design of the unit facilitates maintenance to a minimum. The parts of the unit which come into contact with food have to be cleaned regularly.

- Before any maintenance and cleaning, disconnect the power.
- Set all controls in the OFF position.
- Wait until the inside of the unit is not hot but only slightly warm- cleaning is easier than when warm.
- Clean the surface of the unit with a damp cloth, soft brush or fine sponge and then wipe dry. In case of heavy soiling, use hot water with non- abrasive cleaning product.
- For cleaning the glass of the oven door, do not use abrasive cleaners or sharp metal scrapers, these can scratch the surface or lead to the glass being damaged.
- Never leave acidic substances (lemon juice, vinegar) on stainless steel parts.
- Do not use a high pressure cleaner for cleaning the unit. The baking pans may be washed in mild detergent.

This appliance is marked according to the European directive 2002/96/EC on Waste Electrical and Electronic Equipment(WEEE).

By ensuring this product is disposed correctly, you will help prevent potential negative consequences for the environment and human health, which could otherwise be caused by inappropriate waste handling of this product. The symbol on the product indicates that this product may not be treated as household waste. Instead it shall be handed over to the applicable collection point for the recycling of electrical and electronic equipment. Disposal must be carried out in accordance with local environmental regulations for waste disposal. For more detailed information about treatment, recovery and recycling of this product, please contact your local city office, your household waste disposal service or the shop where you purchased the product.



Supplier's name	ELFA
Model	BLFF65E
Energy efficiency index(EELcavity)	106.0
Energy consumption per cycle in conventional mode	0.89KWh/cycle
Number of cavity	1
The heat source per cavity	Electricity
Volume of each cavity	70L