



OCEAN MOTION

Follow Jesus To The Islands!

**TROPICAL
FIVE DAY
VACATION BIBLE SCHOOL**

Fish You Were Here!



OCEAN MOTION

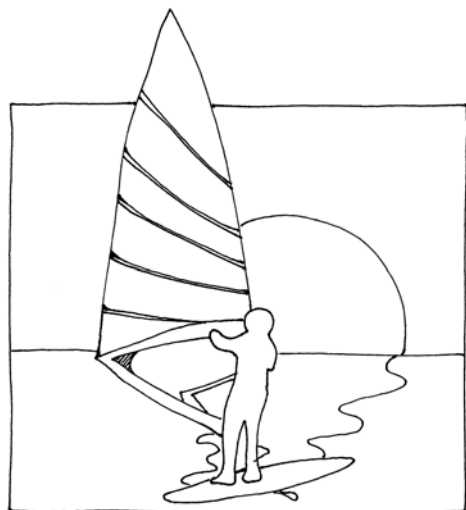

THE STARFISH.....1
 OCEAN MOTION.....2
 TROPICAL HEAT WAVE PREPARATION.....3-4

BIG KAHUNA! CARETAKER-BIG BOSS.....5-6
 CHOOSING THE STAFF.....7
 MEET THE STAFF.....8
 RECRUITMENT.....9

GROUPING KEIKI (CHILDREN).....10
 SAMPLE SCHEDULE.....INSERT
 REGISTRATION TEAM.....11

ISLAND ATMOSPHERE...DECORATE!.....12-13
 DRESSING FOR A TROPICAL ADVENTURE!.....14
 PUBLICITY.....15-16
 PHOTOGRAPHY.....17

THE OPENING-OHANA PARADISE BAY.....18-33
 OPEN HOUSE-ALOHA FRIENDS!.....34
 YE OLDE PIRATE STORY TELLER-WHALE OF A TALE.....35
 MUSIC-SEA CHANTIES!.....36-38
 RECREATION-SANDCASTLE.....39-43
 SNACKS--MAUI CHOWIE BEACH HUT.....44-48
 SCUBA REEF TOURS...UNDER THE SEA.....49-62

ISLAND BIBLE PORTS OF CALL-TIPS FOR TEACHERS.....63-67
 ISLAND PORT OF CALL #1: ISLE OF VIEW.....68-71
 ISLAND PORT OF CALL #2: HOW ARE YA' ISLANDS.....72-74
 ISLAND PORT OF CALL #3: BARNACLE BAY SHIPWRECK.....75-78
 ISLAND PORT OF CALL #4: YOU CAN TOUCAN ISLAND.....79-82
 ISLAND PORT OF CALL #5: THE LIGHTHOUSE.....83-86

PRESCHOOL-THE GUPPIES.....87-



THE STARFISH

The old man walked up a beach
littered with starfish,
beached and dying after a storm.

A young man was picking them up
and flinging them back into the ocean.

"Why bother", the old man scoffed.

"You're not saving enough
to make a difference".

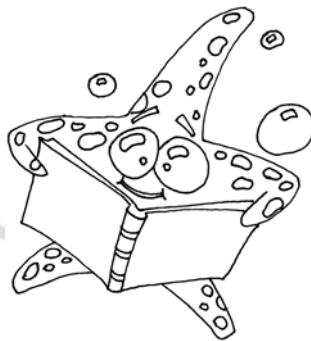

The young man picked up another starfish
and sent it spinning back to the water.

"Made a difference to that one," he said.



Ocean Motion

OCEAN MOTION is a Christ centered five day Vacation Bible School for Preschool and Elementary children. Our tropical island theme is unique so enjoy the warm breezes of friends and family in an exciting south seas environment!

OCEAN MOTION students visit five tropical island surroundings on separate days. Costumed leaders treat the children like tourists on their first island adventure. Bible stories, island activities and a tropical craft project are part of these areas.

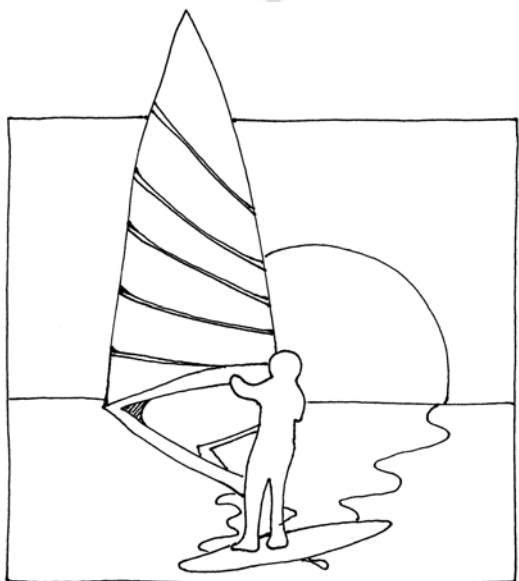

OCEAN MOTION features a variety of fifteen minute daily activities. Gather on the Beach for The Beachcomber's Opening. Eat at Maui Chowie Beach Hut. Swim with the fishes at Scuba Reef. Hear the Conley Twin mystery "Treasure On Esperanza Island" told by Ye Olde Pirate Story Teller. Sing praise songs at Sea Chanties music time.

OCEAN MOTION offers curriculum ideas for a preschool group (Ages 4-5) called GUPPIES. They participate in many of the same activities as older students with a special team or become one of the major tourist groups. Suggestions are included for ITTY BITTY FISHIES, a staff nursery.



TROPICAL HEAT WAVE PREPARATION!

To be called to teach is among the highest callings you can receive. The Christian teacher is entrusted with the sacred responsibility of studying and knowing the Word of God, then carefully sharing this Word in such a way that the pupil 'shall be able to teach others also.'

II Timothy 2:2

-Wayne E. Buchanan, Jr.



These suggestions are a guideline.
Build an exciting vacation Bible School using
OCEAN MOTION Bible stories and activities.

Be creative! Build an exciting island adventure using OCEAN MOTION Bible stories and activities. Teach God's Word from your perspective.

OCEAN MOTION is an activity based event for Preschool (Ages 4-5) through Grade Six students. Involve Grade 7-12, Youth and College students as helpers, team leaders and teachers.

OCEAN MOTION student groups become tourists. Each group wears color coded name tags and sailor hats. Only workshop teachers change groups each day. Students stay in the same group all week.

Workshop teachers decorate and prepare their area. The same Bible lesson is repeated daily to a new group. Adjust teaching activities as needed. A new tourist group arrives each day. Accompany your assigned group wherever they go. Groups must have a leader with them at all times.

Fifteen minute activity teachers see all students each day. Groups travel to music, snack and special fifteen minute activities. Activity teachers prepare five separate daily activities.

Purchase supplies as needed. Give bills to the Beachcomber Director or ask for a check in advance. Look for sales, discounts, theme catalogs and scrap materials from backyards. Craft projects from S&S arts and crafts catalog, Guildcraft catalog and Oriental Trading catalog may be purchased at reasonable prices. Use your church tax exemption number when purchasing materials.



CATALOG AND INTERNET SITES
FOR PRODUCTS WE RECOMMEND

If sample catalogs are not included with this program or have been lost, order free current catalogs directly from each company. Also available from each company...excellent web sites that include pictures of each item. Order directly from each company.

S&S ARTS AND CRAFT CATALOG www.ssww/christian

PO Box 513, Colchester, CT 06415-0513
Phone: 1-800-243-9232 Fax: 1-800-566-6678
(24 Hour Shipping!)

GUILDCRAFT ARTS AND CRAFTS www.Guildcraftinc.com

100 Fire Tower Drive, Tonawanda, NY 14150
Phone: 1-800-345-5563 Fax: 1-800-550-3555

ORIENTAL TRADING COMPANY www.orientaltrading.com

PO Box 2308, Omaha, NE 68103-2308
Phone: 1-800-228-2269 Customer Service: 1-800-228-0475

SMILEMAKERS/CHURCH EDITION www.SmileMakers.com

PO Box 2543, Spartanburg, SC 29304
Phone: 1-800-825-8085 Fax: 1-800-825-6358

U.S. TOY COMPANY www.ustoy.com

13201 Arrington Road, Grandview, MO 64030-2886
Phone: 1-800-255-6124 Fax: 1-816-761-9295

COPY RIGHT INFORMATION

Make as many copies as needed for local church use. Give interested folks our order form, mailing address and toll free telephone number (1-888-236-5433) 1-888-CEM-LIFE. Your cooperation allows CLOSE ENCOUNTERS MINISTRIES to continue production of exciting, inspiring, positive Christian programs at a low cost to churches across the nation. Copyright-All Rights Reserved protected.



BIG KAHUNA!

CARETAKER--BIG BOSS

*'Onipa 'a.
Stand firm.*

Hawaiian Words of Wisdom--Motto of Queen Lili 'uokalani



Hey! You're the BIG KAHUNA Director....cool! Lead students in Tropical Island salvation adventures. This 5 Day vacation Bible School, divided into easy segments, is accomplished by a team of volunteer leaders focusing on individual tasks.

CHARACTER AND COSTUME: As the BIG KAHUNA, become the ultimate Hawaiian leader. Wear a colorful Hawaiian shirt with shorts or slacks. Consider a soft flowing muu-muu with flip flops or wear a hula skirt made of dried grass. Stack several flowered leis around your neck and add sunglasses and a straw hat for a humorous touch!

BEHIND THE SCENES!

DELEGATE RESPONSIBILITY. Vacation Bible School is a team effort. Never apologize when asking for help. Trust your staff to carry out their assigned tasks. Check in with them occasionally as their caring leader--The BIG KAHUNA.

PRACTICE A POSITIVE APPROACH. Statements like "We can't do it", "We never did it this way", "There is no money" or "No one will teach" serve no purpose. If the BIG KAHUNA'S attitude is right, even the grouchiest saint responds cheerfully.

PRAY! Pray for staff, students and the entire event. Take each detail before the Lord and then--Relax!!!

PLAN! Read OCEAN MOTION and note areas requiring special attention. List details you must handle personally. Meet with the staff six weeks before Vacation Bible School begins.



ADAPT! Complete program adaptations to accommodate your local church during preliminary planning to avoid staff confusion.

SET UP! Give adequate set up time. Decorate during the week prior to Vacation Bible School making sure everything is in place for the first day.

STAFF PRAYER. Plan a five minute session one half hour before the day begins. Those who attend will appreciate the "Upward Boost".

GUPPIES PRESCHOOL PREPARATION

Give preschool (Ages 4-5) leaders copies of decorating ideas, teacher information and lesson plans designed for older students. Speak to individual activity leaders to be certain the projects are appropriate for preschool students. Do away with complicated or frightening activities.

Choose age appropriate craft projects from S&S arts and crafts catalog, GUILDCRAFT and/or ORIENTAL TRADING or create your own projects using local craft supplies.

OPTION: Preschool children may be one of the five major groups. They can travel to each planned activity like older students.

Benefits: Less staff, easy planning, less expense and the "grown up" feeling preschoolers get when they become big kids.

Home Base: Provide a room where young students rest and enjoy age appropriate crafts and stories if activities seem difficult. Think about the best way to organize this group of highly motivated children.

PURCHASE/MAKE STAFF THANK YOU GIFTS. This team is vital to children's ministry in your church. There is nothing like appreciation to keep teachers coming back. Pray for them sincerely and thank them privately and publicly.

CLEAN UP. OCEAN MOTION is not complete until the church is in order. Encourage the staff to remove props immediately. Stay to help.



CHOOSING THE STAFF

*'A 'ohe lokomaika 'I I nele I ke pana 'i.
No kind deed has ever lacked its reward.*

Hawaiians are known for their generosity, hospitality and warm sharing. This giving nature is grounded in the principle of reciprocity. When given, the Hawaiian will give back in equal measure or more, be it a gift or a smile.

–Hawaiian Words of Wisdom

RECRUIT

Approach people personally with a specific task. Explain the job fully. No sugar cane coating allowed!!!

BULLETIN INSERT

Include a worship folder bulletin recruitment insert for two or three Sundays. Give people with specific requests their assignment immediately. Explain the insert during worship announcement time dressed in costume. Give this introductory effort the personal touch. See Bulletin Insert Sample.

PICK AND CHOOSE

For remaining positions, call people you know will do a good job. The Lord honors your attempt to have the best staff possible. Pray about staff choices and if someone says "No", assume another person is waiting to fill that place. Use teens, men, women and senior citizens as staff members.



MEET THE STAFF

*Ku 'ia ka hele a ka na 'au ha 'aha 'a.
Hesitant walks the humble hearted.*

A humble person walks carefully, so as not to hurt others.

-Hawaiian Words of Wisdom

PLAN ONE STAFF EVENING TO EXPLAIN
EXACTLY WHAT WILL BE EXPECTED.

Stress 100% attendance so no other meeting will be necessary.

SEAT STAFF ACCORDING TO WORK AREAS.

Distribute specific lesson plans. Build in "chatter" time
to create excitement as teachers and helpers plan their week.

PREVIEW THE ENTIRE PROGRAM

The staff needs an overview of all events
taking place throughout the church.

BE AVAILABLE TO ANSWER QUESTIONS,
ASSIGN CLASSROOMS, GIVE INSPIRATION

Be the person in charge-THE BIG KAHUNA!

AFTER THE MEETING, THE BIG KAHUNA
TURNS ATTENTION TO OTHER AREAS

Trust the staff to carry out their specific activity assignments.

THE TELEPHONE

IS THE BIG KAHUNA/STAFF LIFELINE



CALLING ALL WAHINI AND KANE (women and men):



OCEAN MOTION VACATION BIBLE SCHOOL CASTING OFF FOR BIG ISLANDS!

VOLUNTEER to enjoy ANOTHER DAY IN PARADISE

Check positions for Vacation Bible School. "Ship" all requests to the BIG KAHUNA for an unforgettable tropical experience!

...REGISTRATION	Help Students Sign In	LEAD/HELP
...ART CREW	Make/Set Up Decorations	LEAD/HELP
...PHOTOGRAPHY		VIDEO/SNAPSHOTS/DISK
...SEA CHANTIES	Island Praise Music	LEAD/HELP
...MAUI CHOWIE BEACH HUT	Tropical Snacks	LEAD/HELP
...WHALE OF A TALE	Ye Olde Pirate Story Time	STORY TELLER
...SCUBA REEF	Undersea Adventures	LEAD/HELP
...SAND CASTLE RECREATION	Beach Sand Fun	LEAD/HELP
...GUPPIES PRESCHOOL	Age 4-5 Team	LEAD/HELP
...ITTY BITTY FISHIES NURSERY	Birth-Age 3 Staff Nursery	LEAD/HELP

ISLAND PORTS OF CALL

...ISLE OF VIEW	Come To Jesus	LEAD/HELP
...YOU CAN TOUCAN ISLAND	Learn About Jesus	LEAD/HELP
...BARNACLE BAY SHIPWRECK	Follow Jesus	LEAD/HELP
...HOW ARE YA' ISLAND	Grow In Jesus	LEAD/HELP
...THE LIGHTHOUSE	Shine Jesus Shine	LEAD/HELP
...I HAVE ISLAND PROPS YOU CAN BORROW!		JUST ASK ME!
...I WILL DONATE SNACKS!		I LOVE TO COOK!
...I WILL GIVE A FINANCIAL DONATION!		IT IS WORTH IT!
...I WILL PRAY FOR THE ISLAND CREW!		I CAN DO IT!

NAME _____ TELEPHONE _____

OCEAN MOTION DATES: _____ TIME: _____

Mahalo a nui! (Thanks very much!)—Big Kahuna
May Akua (God) bless you
PUT A LITTLE ALOHA IN YOUR LIFE!



GROUPING KEIKI (Children)

OCEAN MOTION is broadly graded.
Provide a preschool program and five
Island Ports of Call tourist groups of equal size.

ITTY BITTY FISHIES (BIRTH-AGE 3): Will we open this for the community? Will we provide a staff babysitting service?

GUPPIES PRESCHOOL (AGES 4-5): Give preschool children free time and optional involvement in daily activities or include these highly motivated students in one of the five major groups.

COLOR CODE FOR EASY IDENTIFICATION



ITTY BITTY FISHIES NURSERY--No Color Needed
GUPPIES PRESCHOOL--White

Akahai (Gentle--Kindergarten)--Yellow

Ko'Kua (Helpers--Grade 1)--Blue

Lokahi (Harmony--Grade 2)--Green

Ha'aha'a (Humble--Grades 3-4)--Black and White

Mahi (Strong--Grades 5-6)--Red

Overlap ages in any group. If twenty students are in one group and five students in another, switch students regardless of grade. Visiting cousins and friends appreciate joining familiar faces in an unfamiliar situation.

GROUPING OPTION FOR SMALL CHURCHES

With twenty or less students and a few faithful teachers, consider running one daily ISLAND PORT OF CALL with all students in one group. The same teaching team presents a different station each day in the same teaching area. Crafts can be adapted and offered in a separate area using the same teachers or a craft crew. Smaller groups have the luxury of treating students to craft projects carried over from day to day. Students may travel to each activity together.



***** OCEAN MOTION DAILY SCHEDULE *****

STUDENT GROUPS	9:00-9:15	9:15-9:30	9:30-9:45	9:45-10:00	10:00-10:15	10:15-10:30	10:30-10:45	10:45-11:00	11:00-11:15	11:15-11:30
WHITE GUPIES ages 4-5	ON THE BEACH OPENING	CLASSRM	MAUI CHOWIE BEACH HUT	SAND CASTLE REC	CLASS ROOM	WHALE OF A TALE STORY TELLER	SCUBA REEF TOURS	SEA CHANTIES MUSIC	CLASS ROOM	CLOSING
YELLOW AKAHAI (Gentle) Kindergarten	ON THE BEACH OPENING	W O R K S H O P	K S H O P	O P	MAUI CHOWIE BEACH HUT	SAND CASTLE RECREATION	SEA CHANTIES MUSIC	WHALE OF A TALE STORY TELLER	SCUBA REEF TOURS	CLOSING
BLUE KO'KUA (Helpers) Grade 1	ON THE BEACH OPENING	SEA CHANTIES MUSIC	SCUBA REEF TOURS	W O R K S H O P	K S H O P	O P	MAUI CHOWIE BEACH HUT	SAND CASTLE RECREATION	WHALE OF A TALE STORY TELLER	CLOSING
GREEN LOKAHI (Harmony) Grade 2	ON THE BEACH OPENING	SCUBA REEF TOURS	SEA CHANTIES MUSIC	WHALE OF A TALE STORY	W O R K S H O P	K S H O P	O P	MAUI CHOWIE BEACH HUT	SAND CASTLE RECREATION	CLOSING
BLACK HA'AH'A (Humble) Grade 3-4	ON THE BEACH OPENING	WHALE OF A TALE STORY TELLER	W O R K S H O P	K S H O P	O P	MAUI CHOWIE BEACH HUT	SAND CASTLE RECREATION	SCUBA REEF TOURS	SEA CHANTIES MUSIC	CLOSING
RED MAHI (Strong) Grade 5-6	ON THE BEACH OPENING	SAND CASTLE REC	WHALE OF A TALE STORY	MAUI CHOWIE BEACH HUT	SCUBA REEF TOURS	SEA CHANTIES MUSIC	W O R K S H O P	O P	O P	CLOSING

***** OCEAN MOTION GROUP ASSIGNMENTS *****



	MONDAY	TUESDAY	WEDNESDAY	THURSDAY	FRIDAY
OCEAN MOTION WORKSHOPS					
ISLE OF VIEW	AKAHAI	KO'KUA	HA'AH'A	MAHI	LOKAHI
YOU CAN TOUCAN ISLAND	KO'KUA	AKAHAI	MAHI	LOKAHI	HA'AH'A
HOW ARE 'YA ISLANDS	LOKAHI	MAHI	AKAHAI	HA'AH'A	KP'KUA
BARNACLE BAY SHIPWRECK	HA'AH'A	LOKAHI	KO'KUA	AKAHAI	MAHI
THE LIGHTHOUSE	MAHI	HA'AH'A	LOKAHI	KO'KUA	AKAHAI



REGISTRATION TEAM

*Ua ola no I ka pane a ke aloha.
There is life in a kindly reply.*

A kind word or a friendly greeting to a friend is just as important as a gift.

–Hawaiian Words of Wisdom

Make name tags and lead the Registration Table the first day. This job is too big for one person. If there is a tangle at registration, the first day could be delayed as much as thirty minutes.



*Designate individual group colors, names and grades.
Students line up to receive a name tag, lei and sailor cap.*

PRE REGISTRATION: Registration cards simplify the first day by having name tags/sailor caps prepared. Utilize church newsletter, bulletin, special mailing and take home forms. Telephone neighborhood families. Visit nearby neighborhoods. Record name, grade/age, emergency telephone and emergency contact person, environment or food allergy information. If cards are the basis for church growth, add address, parent names.

NAME TAGS: Give each student a colorful tag as ID. Purchase plastic name tag covers from a catalog or local office store. Slide student's name into the sleeve using the appropriate group color. Pin tags to students. Collect tags at the end of each day and place them in the Opening area.

SAILOR CAPS: ORIENTAL TRADING CATALOG offers inexpensive sailor caps (white and other colors) for children and adults. Print the first name on each cap with fabric markers.

The benefit of using a hat is immediate name recognition without searching for a tag. The hats make great gifts to give students. Christian pins may be purchased and attached to the cap for memory work, good behavior and attendance.



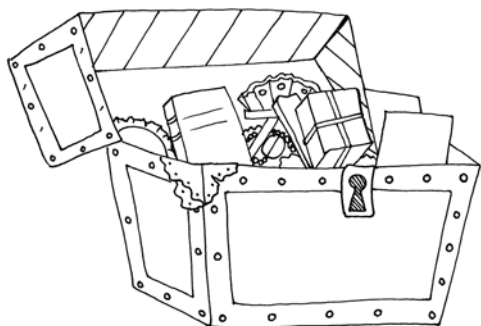

ISLAND ATMOSPHERE

*Mai ho 'oni i ka wai lana malie.
Do not disturb the water that is tranquil.
Let the peaceful enjoy their peace.
-Hawaiian Words of Wisdom*

Create a simple, colorful island environment. Students and guests enter a make believe tropical island complete with palm trees, sand and fishes from the deep. Discuss decoration at the beginning of the planning process. Follow curriculum suggestions or develop your own island style.

*Leaders in individual activity areas decorate their rooms.
Special attention is given to the ONE THE BEACH Opening area.*

Borrow items from church, family and friends. Palm trees and palm branches, fish and nets, toucans and parrots, butterflies, fruit, treasure chests, sailboats and woven straw mats look wonderful. The PORTS OF CALL (Bible Workshops) should resemble separate islands, shipwreck and lighthouse.

SIGNS! Place a large posterboard sign outside each PORT OF CALL announcing the name. Add memory verse signs. Some signs can be printed on old wood or cardboard. Wind ivy vines around each sign for tropical appeal.

Scatter wooden/posterboard road markers through the building:

- | | |
|--------------------------|-------------------------------------|
| SUBMARINE RACES | UNDER THE SEA (Arrow pointing down) |
| CRAB COVE | BARNACLE BAY |
| SHINING LIGHT HOUSE | LOBSTER LANE |
| SHARK ALLEY | TIKI PATH |
| ALOHA AVENUE | MAHALO (Thank You) LANE |
| ANOTHER DAY IN PARADISE! | DOLPHIN DRIVE |



FISH! Make posterboard tropical fish in bright marker or paint. Place on wall throughout the church. The fish should be huge.

ATTIC ITEMS! Ask congregation, friends and family to search their attics, garages and basements for old items that fit the island theme.

WOODEN BENCHES	BARRELS
BASKETS	OLD LOGS
TIKI TORCHES	TROPICAL FLOWERS
ROPE	OLD FENCING
LARGE ROCKS	GREEN PLANTS
WICKER FURNITURE	BEACH BALLS
ANTIQUUE TRUNKS (Treasure Chests)	

LIVE ANIMALS! Borrow a parrot, macaw or other bird in a cage. Owner must remain with their bird while visiting.

PALM TREES! Get cardboard tubing from carpet stores. Spray paint the tube brown or black. Make a wooden cross shaped base to secure the tree. Draw large palm leaves on green construction paper and cutting spikes on an angle. Attach each leaf to a bent coat hanger and attach to top of carpet tube. Purchase real coconuts and place them under the palm trees. *Option: Blow up dozens of green balloons and attach to bent coat hanger. Place inside carpet tube for a great fantasy palm tree.*

FISHING NETS! Hang fishing nets from every corner. A good place to ask for fish decor is at your local grocery store fish department.

FLOWERS! Make huge tissue flowers from colored tissue paper. Wooden dowel rods work well as strong stems. Tropical silk flowers work well too.

ROCKS! Place large rocks in central areas. Green plants may be placed around the rocks.

SAILBOAT! Place a real sailboat or catamaran on the platform in full sail. (flat bottomed.) Oars, life jackets, sails and nets leaning in a corner look great.

WATER! Fill a child's pool with water, rocks, water plants, floating boats and rubber duckies. Surround the pool with green plants and rocks.

BEACH BALLS! Toss lots of beach balls on the floor where students gather.

MUSIC! Borrow or purchase Hawaiian music as background music before the Opening and Closing each day.



DRESSING FOR A TROPICAL ADVENTURE!

Mai 'ena i ke kanaka i laka aku.

Do not shy away from a person who is attracted to you.

Treat a person who comes in kindness with kindness –Hawaiian Words of Wisdom

Part of the fun is making OCEAN MOTION come to life with props and costumes. This does not have to be difficult or expensive. Follow a few tips and let your imagination run wild!

STUDENTS: Costumes consist of a sailor cap, lei and name tag. They wear comfortable summer shorts, tops and sandals.

TEACHERS: Wear appropriate dress depending on the teaching area.

Hula Skirt

Hawaiian Shirt

Muu-Muu (Long, flowing caftan in bright colors)

Sandals/Bare feet

Straw Hat

Sunglasses

Sailor Uniform

LEIS

ANKLE LEI OR JEWELRY

FLOWER OVER ONE EAR

WRIST LEI



PUBLICITY

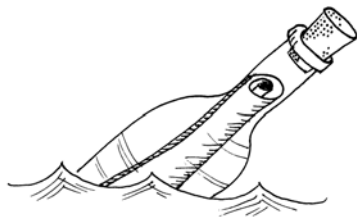

Publicity is vital to vacation Bible School.

Be clear and concise.

Request a specific publicity team.

CHURCH BULLETIN. Begin advertising for staff. Include VBS reminders in the weekly church bulletin until OCEAN MOTION begins. Include registration forms when appropriate.

CHURCH NEWSLETTER. Print quick, catchy announcements and include registration forms in the monthly church newsletter.

WORSHIP SERVICE GREETERS. Greet people coming into church for worship. This is a great reminder that OCEAN MOTION is coming. Dress in costume. Place a student near the door. Give Registration forms and basic information.

LOCAL NEWSPAPER. Take black and white photographs of people in costume. Send a news release several week before OCEAN MOTION begins to insure publication. Invite a local news reporter and photographer. OCEAN MOTION makes a great feature story!

COLORING CONTEST. Sponsor a Sunday School coloring contest. Choose one picture. Display completed pictures. Award prizes to create excitement.

VISIT THE PULPIT. Visit the pastor during announcement time. Give this your best effort so the congregation becomes excited about the event. Play Hawaiian music as you enter the sanctuary. Wear a Hawaiian costume and give basic information.

LETTERS TO KIDS. Send a letter to potential students. Add a small silk flower inside each envelope.



LOCAL TELEVISION. Ask your local television station to tape a feature story. This is great publicity and encouragement. Do not assume a crew will NOT come. Call and ask! Use the local television cable advertising station to print a few lines about your event. This is free or inexpensive.

LOCAL RADIO. Radio stations are required to dedicate air time to local events. Send an announcement to be broadcast several times daily. Christian radio stations also announce Vacation bible School.

NEWSPAPERS AND MAGAZINES. Does your denomination have a communication network? Send pictures and a well written article. You may be pleasantly surprised to find your church featured in the next edition.

SIGNS AND POSTERS. These are the most common forms of publicity. Although considered the least effective, placing signs in stores, offices and other well traveled spots brings attention to your program. Attach tear off sheets stating basic information.

CHURCH SIGN. Place a large sign outside the church announcing dates and times. Use the Island theme to draw attention to the sign. Fly colored flags and pennants. Light the sign at night.

INVITATIONS. Purchase clear zip lock bags and fill them partially with play sand and small shells. Add colorful confetti, a little terry cloth "towel", paper umbrella with a tropical shaped paper containing VBS information and RSVP. Hand these unique invitations to children in Sunday School, neighborhood and mail them to everyone on your VBS list.

SPLISH SPLASH!

COME TO OUR HAWAIIAN VBS BASH! Everyone Age 4-Grade 6

OCEAN MOTION!

VACATION BIBLE SCHOOL

CHURCH:

DATES:

TIME:

Become a Tropical Tourist Learning about Jesus!

RSVP: Call Church Office



PHOTOGRAPHY

Ua ola loko I ke aloha.

Love give life within. –Hawaiian Words of Wisdom

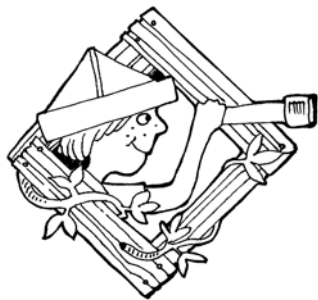

Pictures are a unique way to remember the work and rewards of a visual week. Ask the church photographer to wear an appropriate costume and to join activities with enthusiasm.

ENCOURAGE VISITORS TO BRING CAMERAS. This is a good way to involve parents and church members who visit each decorated area. Amateur photographers usually stand at one side to take pictures and should not disrupt events.

ASSIGN A PHOTOGRAPHY CREW to take pictures. Underwrite the cost of film and developing from Vacation Bible School resources.

COLOR PRINTS. Take pictures early in the week. Facial close ups are the most popular shots. Develop film at a fast developing center. Display pictures at OPEN HOUSE.

DISK PHOTOGRAPHY. Make CD's that can be offered to families. Place pictures on the church internet site.

VIDEO. Delegate one person to video tape all events. Some activities can be staged for filming but it is fun to record events as they develop.

SELLING PICTURES. Be prepared to quote prices. Do you want to cover the cost or defray Vacation Bible School expenses? Print a sign up sheet and display pictures so families may choose at OPEN HOUSE.

DISPLAY PICTURES. View pictures during OPEN HOUSE. Prints may be placed on a wall/bulletin board and video may be shown in the snack area.



THE OPENING

O'HANA PARADISE BAY

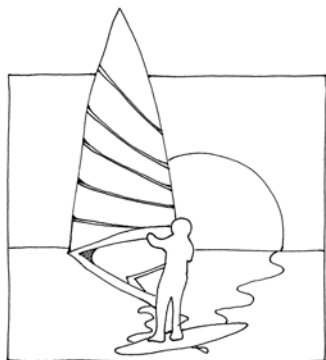

O'HANA PARADISE BAY is a daily fifteen minute "meet and greet" designed to present daily events, make announcements, collect offering, spark enthusiasm and sing. The group enjoys a 5 part skit performed by volunteers.

BIG KAHUNA: The Director leads this daily event dressed in costume. Use curriculum ideas when choosing Island costume.

DECORATIONS-TROPICAL FANTASY

Design a simple, visual focal point for the tropical island theme. Use curriculum ideas suggested in "Island Atmosphere". Create your own island using supplies available locally.

COLLECT KOLA (Money)

Place offering in wicker baskets before students find their seats. Before Vacation Bible School, decide where to donate the offering. If a special mission is designated, let families know. If a contest between age groups or boys vs. girls is desired, communicate this to the students and have fun collecting money.

CHAIRS OR NO CHAIRS

If meeting in a gymnasium or fellowship hall, consider allowing student groups to sit on the floor. Mark the seating area with Palm Trees and beach towels.

SYNCHRONIZE WATCHES

Begin on time even if students are gathering. Welcome, sing songs, make announcements, perform one skit and dismiss. End on time to guarantee groups move to their first activity on time. Direct late comers to their first activity.



BIG'S KAHUNA WELCOME!

Hea hea (heh yah heh yah) Warm, welcoming call
Aloha Ka-kah-ia-ka! (Good Morning!)
Aloha A-u-ina La! (Good Afternoon!)
Aloha A-hi-ahi! (Good Evening!)

Welcome to O'Hana (Family) Paradise Bay! Enjoy warm breezes on tropical islands and delicious kau-kau (food) prepared by wahini (women) and ka'ne (men).

Let's learn Hawaiian phrases we can use all week at OCEAN MOTION. Practice with me:

"Aloha kakou" means "Greetings between you and I".

"Aloha nui loa" means "With much love" or "Warm greetings".

"A hui hou" means "See you again".

"Malama Pono" means "Take care of yourself".

"Mahalo" means "Thank you".

Every time you say hello or goodbye this week, use the word "Aloha". Aloha means many things. It speaks of adoring, loving and respecting people. It is an overall feeling for loving relationships and a caring place. Aloha covers everything from hello and goodbye to "Goodbye and farewell forever".

Because we will become O'Hana (family) this week, it is right for us to treat each other with *Aloha* love and respect.





THE SPIRIT OF ALOHA

Adapted from a sermon by Rev. Abraham Akaka at Kawaiahao Church, Honolulu, Hawaii (March 3, 1959) on the day Hawaii became a state of the Union. Choose several people (children/adults) to read the information. Use as many people as available. It can be presented by one, two, three or more readers.

- I. Aloha is the power of God that unites heart with heart, soul with soul, life with life, culture with culture, race with race and nation with nation.
- II. Aloha is the power that reunites when a quarrel has brought separation.
- III. Aloha is the power that reunites people when they feel separated from God. When a person lives in the spirit of Aloha, he/she lives in the Spirit of God.
- IV. Aloha is the desire to seek the true good of other people in a friendly spirit, out of a sense of kinship.
- V. Aloha seeks to do good, with no conditions attached. We do not do good only to those who do good to us. One of the sweetest things about the love of God and Aloha is that it welcomes the stranger and seeks good for that person.
- VI. A person who has the spirit of Aloha loves even when the love is not returned. And such is the love of God. Aloha shares the sorrows and joys of people. It seeks to promote the true good of others.
- VII. From the beginning, all humankind has been watched over by the love of God. The Golden Rule "*Do unto others as you would have them do unto you*" is Aloha. This is the way of life we shall live this week.
- VIII. May Aloha, the Spirit of God, be at work in you and in me, bringing new light and life to all who sit in the darkness of fear, guiding the feet of humankind into the way of peace.



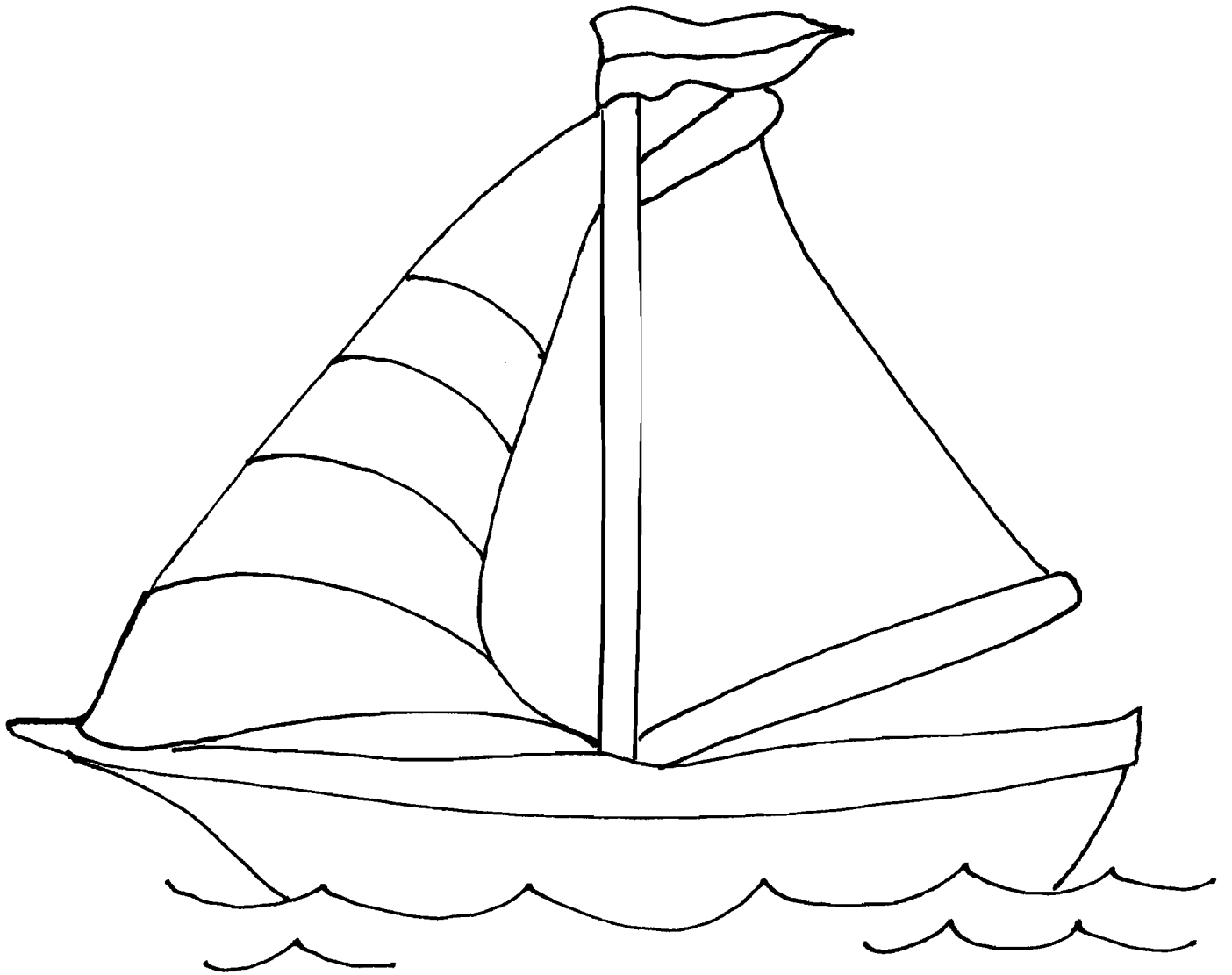

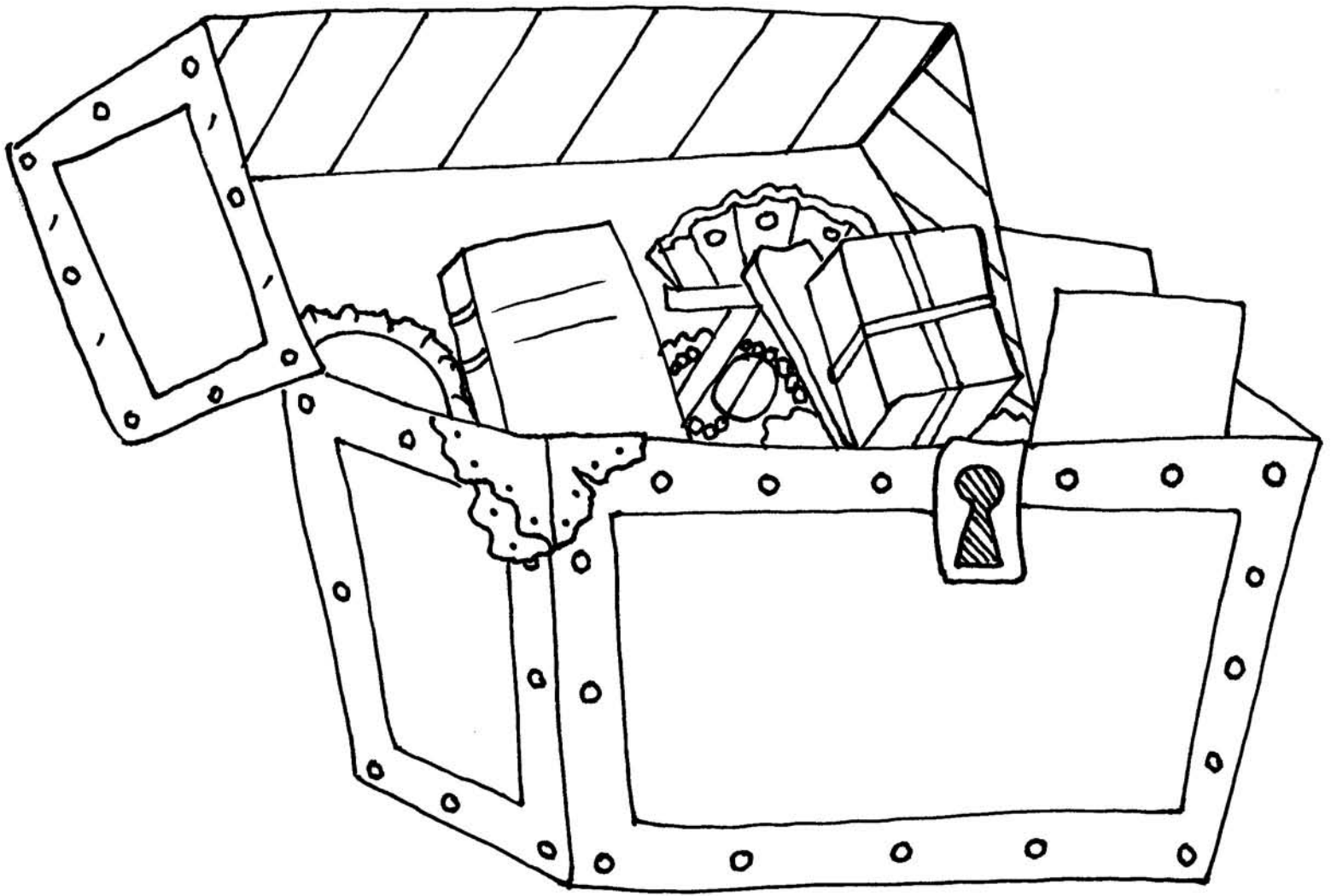

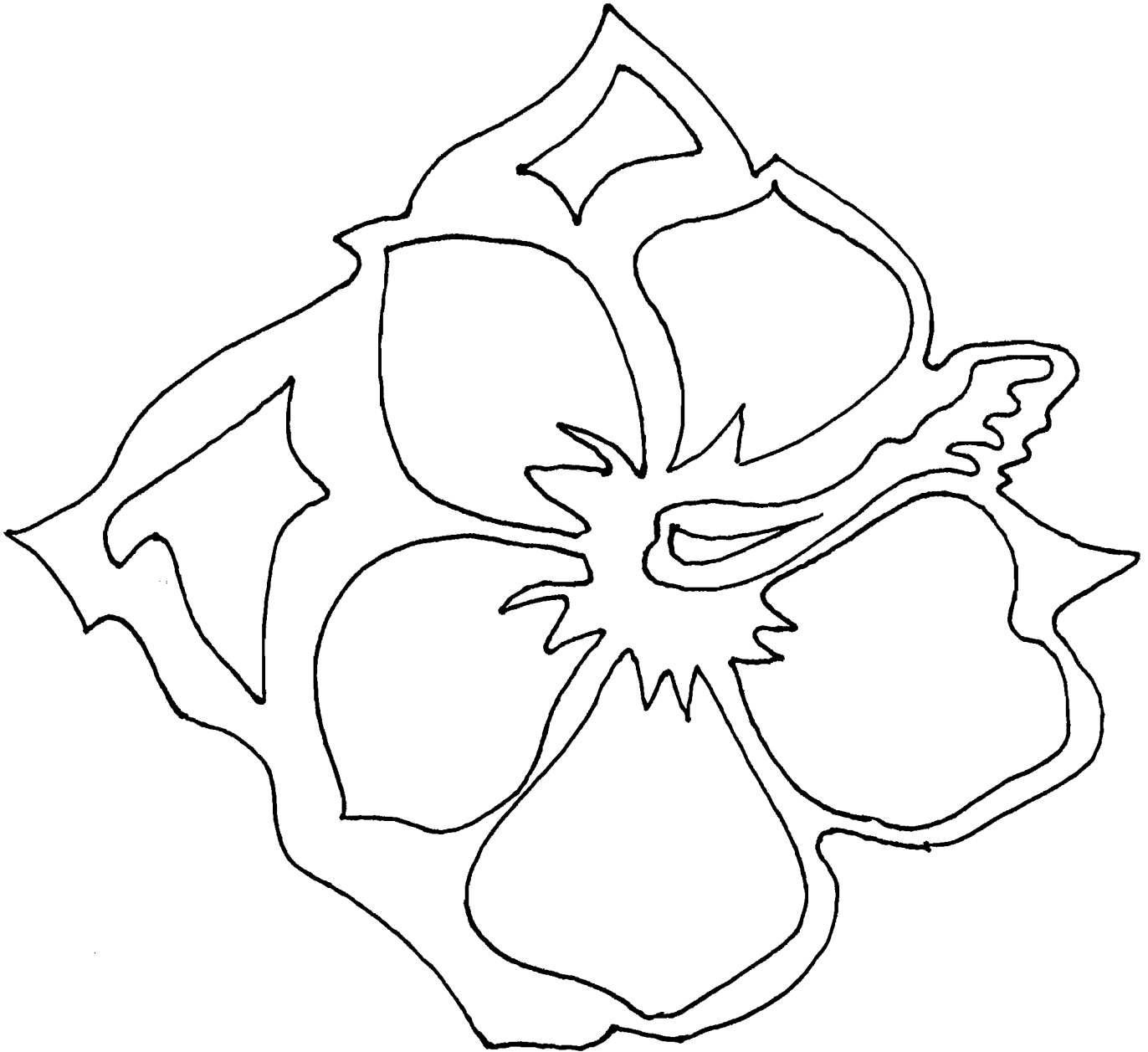

O'HANA PARADISE BAY HOT! HOT! HOT! DAILY SKITS

Rehearse before the week begins.
Do NOT memorize the skits. Speak clearly.
Dress in costume for your character.

CHARACTERS

KOLOHE (Koh-low-hay) - Rascal
BEACHCOMBER - Cranky Adult

Actors. Male or female of any age. Old beach hats, sandals, Hawaiian shirts/t-shirts and heavy sun screen make the beach characters come to life on stage.

Props. Carry items as suggested at the beginning of each skit. The skits are based on washed ashore items so the items can look old, wet, worn out.

Do Not Memorize! Participate in each vignette with enthusiasm. Portray these tropical characters with grace and humor.

Speak Up! Slow down and speak clearly. Use a microphone if one is available.

Have fun!!! The five skits are filled with funny lines as well as a spiritual lesson to be learned.



DAY ONE
HOT! HOT! HOT!

Props: Large shell, buckets for each actor.

BEACHCOMBER: *(Enter from side, in a grumpy mood)* Whew! It is hot, hot, hot on O'Hana (Family) Paradise Bay. I almost didn't come today. I'm not in the mood for silly tourists and kids who don't know how to swim. I always find some treasure to keep or sell. I live in that beach hut over there. My daily needs are simple. A little kau-kau (food), a bit of sunshine and a good friend with a ukelele.



KOLOHE: *(Enter from the back, making noise and shouting....)*
A-loww-HA!

BEACHCOMBER: I was afraid of that. That's Kolohe, his name means "Rascal" and trust me, he is exactly what his name means. I'm not in the mood for that rascal today. If you will excuse me, I am going to disappear. *(Exit quickly)*

KOLOHE: *(Walk to the stage.)* Hey, wasn't the Beachcomber just here? I'm sure I saw him kicking around in the sand. How could he disappear that fast? Oh well, I'm here and that's all we need, right? Whew, it is hot, hot, hot today. I almost didn't come today but I know how much the Beachcomber misses me when I stay home. Hey, there he is! Beachcomber! Over here! I found something by the water!

BEACHCOMBER: *(Shouting...)* That's okay! You found it, you keep it! Gotta run!

KOLOHE: No! Come back! I found a treasure!

BEACHCOMBER: You caught me. Be quick. What did you find? I have people to see, places to go and things to do.

KOLOHE: Look, it's a sea shell. It was right on the edge of the water.

BEACHCOMBER: Kolohe, I hate breaking this to you but a sea shell is not exactly a treasure. Call me when you find a diamond ring or a gold watch.



KOLOHE: Can't you see the beauty in this shell? It is a wonderful treasure. Why, this shell is a creation of God. You should know that better than anyone. As a beachcomber, it's your job to know what a real treasure is.

BEACHCOMBER: I know real treasure and it's not an old, empty shell.

KOLOHE: Every time I see a shell I am reminded that God provides shells for His soft sea creatures to use as a home. When the animals are done living in them, they shed their home and it washes to shore for humans to find and enjoy all over again. Isn't that just like the Lord? He creates something useful and allows us to enjoy it's beauty instead of throwing it away.

BEACHCOMBER: Kolohe, you need a brain between those ears. There are millions of shells on hundreds of beaches across the world. Who cares about one shell?

KOLOHE: God cares. There's a lesson here someplace if I can just think of it. Hmm, I've got it! The Bible says even the hairs on our head are numbered. God knows how many grains of sand are on this tropical beach! God knows everything about me. He knows everything about you.

BEACHCOMBER: You have given me something to think about today. Maybe I should have been more aware of details that show God cares about me. From now on, when I see a beautiful seashell, I'll remember that God created it and He cares about me too!

KOLOHE: That's great! Now, since it's so "hot, hot, hot" out here on the beach, let's get some icy cold lemonade. I'll bring the seashell and you bring the money for the lemonade.

BEACHCOMBER: I get it. You're still the rascal I've always known, Kolohe. Let's go! By the way, I'll carry the shell and *you* bring the lemonade money.

Exit together.



DAY TWO
HOT, HOT, HOT!

PROPS: Old Tin Can



KOLOHE: I found this old tin can on the beach this morning. I picked it up before a tourist stepped on it and cut their foot and bled all over the sand and called an ambulance and had stitches and ruined their day.

BEACHCOMBER: Yeah, you're a thoughtful kid. I'm impressed. Not to mention that thing isn't much of a treasure, no one wants it. It lost it's usefulness. Just toss it in that garbage can over there and help me find a few more shells before the best ones are gone. I see a bunch of people running our way. Hurry up! Grab that good one by your foot before they get here!

KOLOHE: Not useful! Are you talking about *this* tin can? It's useful to me. In fact, I consider myself quite lucky this hot, hot, hot morning.

BEACHCOMBER: Alright, I can see I'm going to get a speech. Tell me, how can you use that rusty old thing for anything remotely resembling usefulness?

KOLOHE: Why, I can think of a bunch of uses for this old can. For instance, I can bail out my boat. I can fill it with fishing worms. I can carry my shells home. I can wash it out and fill it with pens and pencils on my desk. Yep, there are lots of uses for this old thing.

BEACHCOMBER: You have got to get a job, kid. Who wants to look at a rusty old can on a desk? It's just junk. Pure junk. All junk. Junk, junk. Got it? Even God would think that thing is junk.

KOLOHE: Aha!

BEACHCOMBER: Oh no, I said "God" didn't, I? And you have a lesson to teach me, don't you?

KOLOHE: Listen to this! We think we are like this old tin can. How can God use me? I'm not smart. I'm not good looking. I don't have talent like my friends.



BEACHCOMBER: I don't think I'm junk. I'm smart. I'm good looking and I am filled to the brim with talent!

KOLOHE: Then this lesson isn't for you. If you (point to audience) think you are junk, cut it out because "God doesn't make junk!"

BEACHCOMBER: Oh, I get it. God makes only the best of the best.

KOLOHE: Just like this old tin can, you can be used by God many ways.

BEACHCOMBER: Okay, I'll listen. How can God use me?

KOLOHE: It's not "how" it's the "want to's". The key to being used by God is in the wanting. If you want to serve God, He will find a spot for you to serve Him. And the best part is, God will use you just the way you are. He will take what you think is the "junk" of your life and turn it into real treasure.

BEACHCOMBER: You mean I don't have to give away my superior brain power or my rugged good looks or my amazing talent to be used by God?

KOLOHE: Ummm, I guess that's right. God can even use people who *think* they are smart, handsome and talented. Somehow, and I'm not sure how He does this, God changes you from the inside out to make you the perfect servant.

BEACHCOMBER: Do you think God can use the Best Beachcomber for anything truly great? I mean, I'm willing, but I love being a Beachcomber.

KOLOHE: The Bible says, "A man is known by his actions. An evil man lives an evil life, a good man lives a godly life." (Proverbs 21:8) Match your actions to your wants and you will find yourself serving the Lord and being happy! Others will know you for your good life.

BEACHCOMBER: Why Kolohe, you rascal, you actually taught this old Beachcomber something today.

KOLOHE: And don't you (point to audience) forget the lesson of the old tin can. I isn't junk at all!

EXIT TOGETHER.



DAY THREE HOT, HOT, HOT

PROPS: Large, empty bottle with note rolled up inside and one coin.

BEACHCOMBER: *(Running down the center aisle to the front-yelling!)* Look! Look what I found this morning! I have waited my whole beach combing career to discover this kind of historical treasure. Wow! This is great! I could be a millionaire! Wow! I cannot believe my good fortune!



KOLOHE: *(Running down the center aisle)* What happened? What happened? I can hear you yelling all the way to the souvenir shop! Did you step on broken glass? I told you to wear your sandals. Quiet down, you're scaring the tourists!

BEACHCOMBER: Kolohe, look what I found. It's a mystery. It's a treasure. It's great! Look! Look!

KOLOHE: I'm looking....I'm looking! Why, that's just an old bottle that washed up on shore with the tide. I've see a million of them.

BEACHCOMBER: Look closer. It's more than an old bottle. It has a message inside. The paper looks old and there's a coin in there with it. I bet it's a pirate's gold doubloon! Worth millions!!!!

KOLOHE: *(Hold bottle up and examine it carefully.)* Why, I think you are right. There is something inside this bottle. What makes you think it's a treasure? It could be a laundry list for all you know.

BEACHCOMBER: I can feel it in my bones. I have searched this sandy beach for years for treasure and it's finally time for me to retire to my mansion on the hilltop!



KOLOHE: I agree that you have been faithful while searching this beach but what is a treasure...really? Maybe the years you have spent in the bright sun is the treasure you seek?

BEACHCOMBER: Are you crazy? All I ever got from the tropical sun is burned! I mean cash, cold cash. This bottle is going to make my final days comfortable.

KOLOHE: Your final days! You aren't old enough to be thinking about your "final days". Money isn't everything. There are other treasures worth much more.

BEACHCOMBER: Name a few. I bet there isn't one treasure you can name that would be better than a barrel of money.

KOLOHE: How about your good name? How about a cozy beach hut and delicious food? Friends! Now there are treasures you cannot replace for all the money in the world! Tell the truth, what would you do without me?

BEACHCOMBER: Hmm, let me think....oh, you're right. Even though you are a rascal, you keep me walking the right direction. If you were not on the beach, I might never think about God's goodness at all. But....the treasure I've been seeking all my life is in my hand. Don't ruin it for me. Be happy for me.

KOLOHE: I am happy for you. Let's see what treasure has washed ashore. Can you get the note out of the bottle?

**BEACHCOMBER AND KOLOHE WORK TOGETHER
TO TAKE THE NOTE AND COIN FROM THE BOTTLE.**

BEACHCOMBER: Let me read it! I know it's going to be a map with directions to a treasure chest on one of the islands around here. I just know it!



To the Finder of this Message:

I have been stranded on O'Hana Island for a month. Food is running low and my small boat sank in the surf. Help me! Please call this phone number to tell my family to come and rescue me. I am enclosing a quarter for the phone call. If you find this message, know that I am leaning on the Lord for safety.

Even if I perish, listen to this wise advice. Follow it closely. It will do you good. It is a treasure you can pass along to others: TRUST IN THE LORD.

*Rescue me and there will be a reward. Bob
Call 555-1234 to report my whereabouts*

KOLOHE: Well I'll be ding donged! That's the best note I ever read. The best advice when you face trouble is "Trust In the Lord". That's why they print it on our coins so that we remember "In God We Trust".

BEACHCOMBER: (Quietly) You are right. I was so concerned about cold, hard cash that I completely forgot God has many other treasures in store for me. I have to find a phone. Just in case Bob is still stranded, I've got to save him. He must have been on that island awhile. I can't remember the last time anyone used a pay phone after cell phones became popular.

KOLOHE: Our mysteriously stranded "Bob" is also a great lesson reminding us God's treasures are always the best. I'll help you find a phone. Hey, you forgot the bottle! Maybe you can return it to the grocery store for the bottle deposit!

EXIT QUICKLY



DAY FOUR HOT, HOT, HOT

PROPS: 2 Sand Dollars (Real or traced from cardboard)

Enter together and keep speaking together as indicated.

KOLOHE: I hit the jackpot today! I found a sand dollar!

BEACHCOMBER: I hit the jackpot today! I found a sand dollar!

KOLOHE: No, I found a sand dollar!

BEACHCOMBER: No, I found a sand dollar!

KOLOHE: You found a sand dollar?

BEACHCOMBER: You found a sand dollar?

KOLOHE: Wait, we can't both talk at the same time. Tell me what you found.

BEACHCOMBER: I found a sand dollar this morning as I walked along the beach. I looked down and there it was, perfect in every way. I cannot believe a tourist didn't scoop up this little treasure.

KOLOHE: To find this beauty, I had to wade out to a sand bar in the ocean. I stood quietly and felt around the sand under the water with my toes. Soon I felt a hard object under my foot. I carefully put it between my toes and lifted it to the surface of the water.

BEACHCOMBER: Isn't there a legend about the sand dollar?

KOLOHE: It is said that the sand dollar tells the story of Jesus. Let's see if we can remember how it goes.



BEACHCOMBER: The five slits on the edge represent the wounds Jesus suffered on the cross showing the nails in His hands and feet and the wound in His side.

KOLOHE: And there is an Easter Lily design in the top center with a five pointed star in the center. Turn it over and there is the outline of the Poinsettia, the Christmas flower.

BEACHCOMBER: If I break the shell, five small doves will fall out. I like to think of them as the doves of peace.

KOLOHE: The sand dollar is the best of treasures because it reminds us that the story of Jesus is precious to those who love and follow Him. We are followers of Jesus if we do as He asks and lead our life using His life as our example.

BEACHCOMBER: Who would have thought that talking on the beach would yield such a treasure? Let's keep looking.

EXIT TOGETHER, LOOKING DOWN
AS IF SEARCHING FOR TREASURE.

PREVIEW PROGRAM ONLY
NOT FOR USE
PLEASE PURCHASE



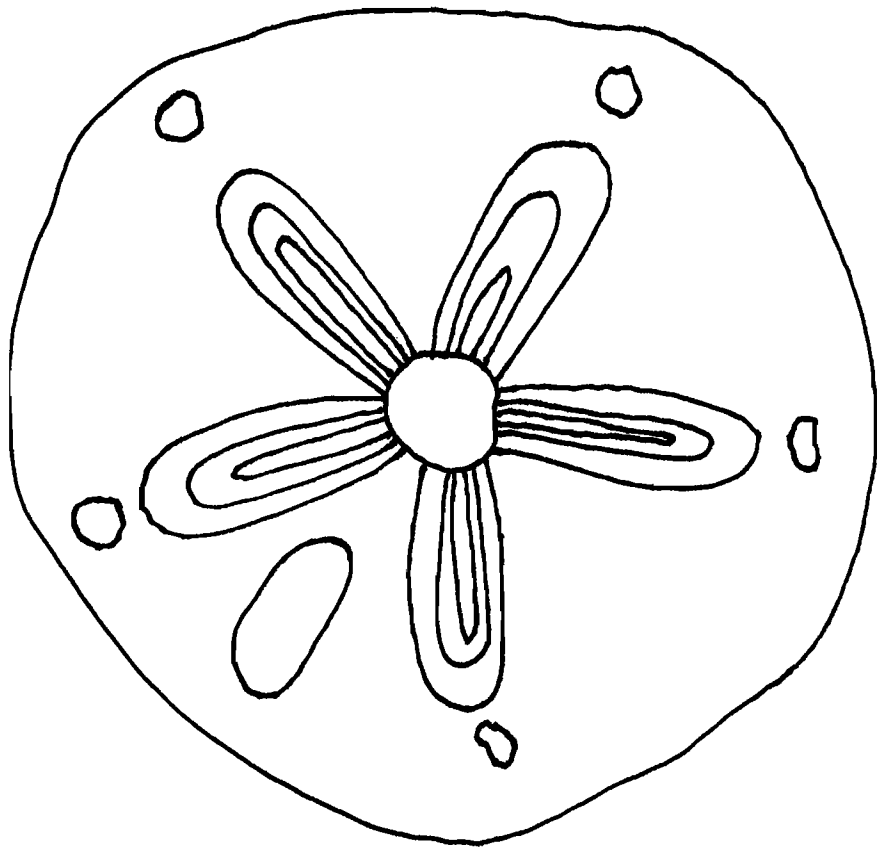

DAY FIVE HOT, HOT, HOT

PROPS: Lots of coins in a wooden box, cool drink for Kolohe

BEACHCOMBER: *(Carry coins/box. Show audience during entrance.)* I found a treasure chest! I'm rich! Look at these wonderful coins. They must be worth millions! I knew if I searched long enough this week, I would find a most excellent treasure. I will never have to be a beachcomber again! Woo! Hoo!



KOLOHE: *(Sitting comfortably on the stage with a cool drink)* I hear you. You don't have to holler. So, you never have to be a beachcomber again. Interesting. Ever since I have known you, you have combed these beaches along O'Hana Paradise Bay. I must admit, I'm going to miss you.

BEACHCOMBER: Yeah, and I'll miss you...but not that much. Oh, maybe I'll think about you once in awhile while I'm lying on my deck chair on the back of my very large, very fancy yacht. But, on the whole, I think I'll be okay with it.

KOLOHE: Whatever you say. I just think you might consider what such a huge life change could do to you. For instance, a lot of money brings with it a lot of serious responsibility. Are you ready for that? You know, board rooms, secretaries....taxes!

BEACHCOMBER: Taxes! I never thought of that. Do you suppose I'll have to pay taxes on this treasure?

KOLOHE: *(Taking a few coins from the box...)* Oh yes, about this much and maybe more. But that still leaves quite a lot.

BEACHCOMBER: Whew! I still have money left for a big house and a big car.

KOLOHE: *(Taking more coins from the box...)* Yes, this ought to be enough. Or, a bit more! Houses and cars are expensive these days. What about clothes? You know, your tattered old beach combing clothes will never do while you are meeting with your banker.



BEACHCOMBER: My banker? I don't have a banker.

KOLOHE: (Taking more coins....) Trust me, you will. And they are very expensive.

BEACHCOMBER: Is there anything else I will need?

KOLOHE: (Taking more coins....) Your new friends will expect to be treated very well by such a wealthy person. You can't expect them to eat hot dogs and drink kool aid like I do.

BEACHCOMBER: What's wrong with hot dogs? I personally love 'em...burned black.

KOLOHE: (Taking more coins....) Oh no, that will never do. You must serve them steak and lobster and shrimp.

BEACHCOMBER: There is not much treasure left in the box, Kolohe. Maybe you should be my personal assistant to see that I watch my budget very carefully.

KOLOHE: (Dumping the rest of coins....) Okay, but I am very expensive. I've become accustomed to the good life.

BEACHCOMBER: (Turn over empty box....) Hey! There's no more money left. I'm broke!

KOLOHE: That's okay. You can always be a beachcomber. You're good at it!

BEACHCOMBER: I AM good at it! In fact, I love it. I enjoy early mornings on the sand. It is wonderful to find things no one else finds. Why would I want to stop doing what I love?

KOLOHE: Sometimes riches and money cloud our vision of what is right and true in life. Jesus said, "It is easier for a camel to go through the eye of a needle than for a rich man to enter the kingdom of Heaven." Matthew 19:24



BEACHCOMBER: Why, I'm already rich. I have enough to eat, a place to sleep, a good job and I love the Lord. Why would I want to change all that and risk losing what I have? Maybe I will put these coins back into the sand for someone who really needs to find them.

KOLOHE: (Hiding coins....) What coins?

BEACHCOMBER: The coins over there, friend. You've taught me the lesson now give me the coins.

KOLOHE: Just kidding! Sometimes learning to follow the Lord is hard. Don't worry we'll both learn. Let's take a walk along the beach and think about the next treasure we are sure to find.

PREVIEW PROGRAM ONLY
EXIT TOGETHER.
NOT FOR USE
PLEASE PURCHASE



OPEN HOUSE ...ALOHA FRIENDS!

*"The real test of their learning is what happens the next week."
-Mary LeBar*



Students and teachers show off decorated workshops, sing songs and display crafts. Families tour, sampling tropical snacks at Maui Chowie Beach Hut while enjoying a tropical island evening.

All costumed teachers and helpers are responsible to be in their work area during OPEN HOUSE.

Choose Open House time so a high percentage of parents and friends may attend. If the week end Friday, plan a Friday evening program. Do not eliminate students' last day of programming if VBS is taking place in the evening. Some churches present the Open House on Sunday morning. Eliminate Aloha Friends if no common time can be found.

ALOHA FRIENDS SCHEDULE

7:00 P.M.	WELCOME AND OPENING PRAYER
7:02 P.M.	INTRODUCE "OCEAN MOTION" THEME
7:07 P.M.	STUDENTS SING _____
7:10 P.M.	STUDENTS RECITE MEMORY VERSES
7:15 P.M.	STUDENTS SING _____
7:20 P.M.	OFFERING
7:25 P.M.	TEACHER APPRECIATION AND GIFTS
7:35 P.M.	STUDENTS SING _____
7:38 P.M.	CLOSE IN PRAYER
7:40 P.M.	DISMISS GROUP TO TOUR "OCEAN MOTION"
8:30 P.M.	STAFF BEGINS CLEAN UP



YE OLDE PIRATE STORY TELLER ...WHALE OF A TALE

This optional fifteen minute Activity Center offers a delightful story and rest!

WHAT IS WHALE OF A TALE? Pirate Story Teller greets small groups cheerfully and tells a continuing story with great enthusiasm. Choose a quiet room far from the noise of the day. Students hide away and hear a five day story in fifteen minute segments.



HOW SHOULD I DECORATE? Place a comfortable chair at one end of the room. If a wicker chair is available, use it. Use curriculum suggestions to choose tropical decor. Throw colorful pillows on the floor where students relax as they listen. Blow a gentle fan across the room to cool the students. Except for the reading light, keep the room dimly lit.

WHAT SHOULD I WEAR? Be comfortable. Consider becoming a pirate with ragged pants, scarf tied at waist, hoop earring, pirate hat or scarf, eyepatch!

WHO HEARS THE STORY? All student groups visit fifteen minutes each day. Preschool students are scheduled to visit but if the continuing story does not interest them, substitute other stories. Choose five separate preschool stories from your local Christian bookstore or from a private collection. It may be desirable to choose another activity for the young group. Discuss choices with the preschool team before Vacation Bible School.

WHAT STORY DO I TELL? Our suggested story is TREASURE ON ESPERANZA ISLAND, a five day Conley Twin adventure with complete script and line drawings. Order separately from CLOSE ENCOUNTERS MINISTRIES 1-888-236-5433 or www.cemlife.com



MUSIC ...SEA CHANTIES!

Sing to the Lord a new song. Shout! Play beautiful music. -Psalm 33:3



This is a fifteen minute daily music session for small groups. Sing Christian praise choruses filled with joy for the Savior. Choose upbeat, contemporary Christian choruses. Lead with enthusiasm and good humor.

DECORATION. If you meet at the O'HANA PARADISE BAY OPENING, no additional decoration is needed. When using a separate area, follow tropical decorating ideas from the curriculum.

COSTUMES. Use curriculum costume suggestions to dress appropriately. Bright, tropic colors work well.

HAWAIIAN PRAISE TEAM. Choose teens and adult to lead songs with microphones and music stands. They become the praise team. This appealing contemporary style is enjoyed by all.



MUSIC. We suggest music from a Hawaiian company to purchase separately. You may have praise songs in your personal collection that will meet your needs for the week.

Leon & Malia have been providing quality educational entertainment for Hawaii's children through live concerts, children's programming and lesson kits for kids ages 3-12. Catchy songs coupled with a complete set of lyrics for each song brings Hawaii and the Savior into your classroom.

"Hawaii Kids Praise"

At last...a praise album from the children of Hawaii! Hear the joyful, uplifting voices of Hawaii's children raised in songs of praise with Leon & Malia. Sung in English and Hawaiian. Preview the music at the website! Also....free lyric sheets are available at the website (Acrobat PDF).

ORDER CD: www.HawaiiKids.net
\$14.99 (Allow 4-6 weeks for delivery)

1. Keiki Praise (All The Children Praise Him)
2. E Ke Akua (Dearest Lord)
3. Lord of All (Jesu Kristo no ka Haku)
4. Jesus Loves Me (Keiki Aloha)
5. Malama I Ka Aina (Caring For The Land)
6. Eia Makou (Here We Are, the children of Hawaii)
7. Lokomaika'i (The Good In You and Me)
8. E Na Punahеле (Oh beloved, love one another)
9. Glory, Glory Lord (Nani, Nani Lehova)
10. Lord Of The Islands
11. Hawaii Aloha



Consider having fun with two original song lyrics set to familiar tunes. Sing acapella. (CEM does not have sheet music available.)

I'M CHRISTIAN THE SAILOR KID

(Tune: Popeye The Sailor Man)

I'm Christian the Sailor Kid. I'm Christian the Sailor Kid.
I can avoid sinning, with Jesus I'm winning.
I'm Christian the Sailor Kid. (Toot, toot!)

I'm Christian the Sailor Kid, I'm Christian the Sailor Kid.
I'm saved today 'cause I found The Way.
I'm Christian the Sailor Kid. (Toot, toot!)

I'm Christian the Sailor Kid, I'm Christian the Sailor Kid.
Don't be a dinghy, just come on and 'sing-y',
I'm Christian the Sailor Kid. (Toot, toot!)

I'm Christian the Sailor Kid, I'm Christian the Sailor Kid.
Come meet the Master...Please do it faster.
I'm Christian the Sailor Kid. (Toot, toot!)

SING FOR MY SAVIOR ALL DAY

(Tune: My Bonnie Lies Over the Ocean)

I'll travel along God's great ocean. I'll float above water all day.
I'll increase my spirit's devotion, And find I can serve Him today.

*CHORUS: Sing now, sing now, I'll sing for my Savior all day, all day!
Sing now, sing now, I'll sing for my Savior all day!*

My Jesus has given me peace, My Jesus has given me bliss.
My Jesus has given me treasure, My Jesus I thank you for this.

CHORUS

I AM God'S youngest disciple. He bids me to work and to pray.
If He will give strength for the journey, I'll worship and walk in His way.

CHORUS



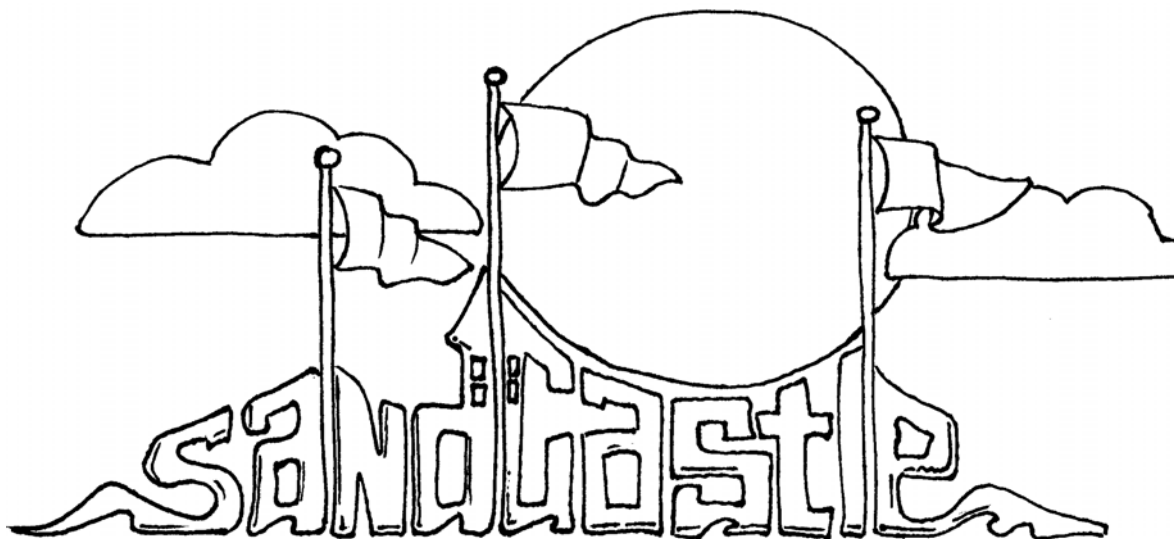

RECREATION

For The Young and the Reckless!

Real learning takes place when the boy gets into the Book and the Book gets into the boy. Thus learning is an active inner process. It is not enough for the pupil to sit and listen and read. —Mary LeBar

SAND CASTLE RECREATION is a daily fifteen minute game time. Play games with a tropical theme. Use our game suggestions or design your own from favorite local activities your students enjoy. The goal is to create an island party!

COSTUME. Dress comfortably. Use curriculum suggestions but wear clothing that allows you to move quickly while leading active games.

DECORATION. Choose an outdoor area large enough for running, jumping, ball playing and circle games. And...find a place where sand can be delivered, dumped, enjoyed and removed late or incorporated into the area. Music: Beach Boys CD's—Surfin USA, Wipeout and Kokomo also work.

EQUIPMENT. Collect supplies. Practice each game and adjust event rules for your group. Print descriptions for each game on separate 4 x 6 cards to develop easy daily organization. Place equipment within easy reach in marked and moveable covered plastic tubs.



REWARDS. Award stickers to winning students/teams. At the end of each session, treat everyone. Pieces of soft candy are popular prizes. Gather a variety of treats like Hershey Kisses, Twizzlers, pretzel sticks or other small treats. (Caution: No peanuts or hard candy!)

PLAY TIPS. It is better to over plan in case a particular game falls flat. Plan a few rainy day activities. You never know when a stray cloud will chase your gang inside. Establish rules to protect students. Choose activities according to age. Do not be afraid to repeat games. Practice makes perfect!

SAND CASTLE FUN!

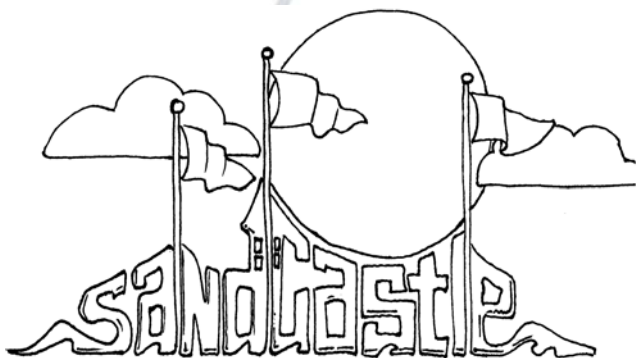

Consider this “sandy” option to create the “oo-ahh” factor! Dump a large sand mound on church property. Use sand usually purchased for children’s sand boxes. Choose a spot that is safe and will do little damage. If placed on dirt or gravel parking lot, the sand can be smoothed into the ground after VBS. Collect sand toys, buckets, shovels, sifters and other fun sand sculpting toys. Cover the sand mound each evening with a large tarp.

RULES. Establish rules to protect all students. No sand can be thrown, blown or kicked on another person. Break the rule and sit out recreation time. Remove shoes and socks to keep them sand free. Line shoes in a specific area for easy access at the end. Bare feet are more fun anyway.

CLEAN UP. Brush students thoroughly before entering the building. Consider bringing a leaf blower to blow sand from students. Think about washing hands and feet in a bucket of water. Dry with old towels. It is inevitable that a bit of sand will be tracked into the building but keep it to a minimum. Oh, the fun and memories you will provide if you put up with the mess!

PERSONAL NOTE: When CEM lab tested SAND CASTLE RECREATION in a local church, the Sand Castle crew was so conscious of removing sand from students that the janitor actually complimented them at the end of the week for a sand free church!



Treasure Seekers

Hide inexpensive treasures in the sand pile. Each seeker receives a small bag and searches for treasures. To avoid greed, place a total number of items each student may find and keep. They can trade later if they get more than one of any kind of treasure. Suggestions: Pennies, nickels, erasers, small toys, sailboats, rings, key chains. (Check ORIENTAL TRADING catalog for inexpensive "stuff" purchased by the gross.)

Bury The Leader

Leaders dress in old clothes, goggles and wrapped in a soft sheet for protection. Students dig a hole, place leader in it and cover (except for head) within time limit. Take a picture of the buried leader surrounded by the group.

Sand Castle

Using water, toys and tools, student groups build a huge sand castle. Each group gets to knock the previous group's castle down before beginning their castle. Or, have groups add to the existing castles. Take pictures to preserve the great castles.

Barefoot On The Sand

Students play in the sand in their bare feet. They may walk in it, pool water to wade or do anything that is fun. Older students may want to build something or just talk quietly as they sit in the sand. Provide toys and tools for just plain sand fun.

MORE TROPICAL FUN AND GAMES...

If you decide to play more traditional games, here are a few "tropical" suggestions to get you going! Choose games that are age appropriate. Plan more games that time allows...just in case a game doesn't work well with any given small group.



Hot Coconut

Play "Hot Potato" using a whole coconut. Pass the coconut around the circle from person to person quickly, while music is playing. When the music stops, the person holding the coconut sits in the middle or controls the music.



Tropical Relay Race

Equipment: Two grass skirts, 2 pair bermuda shorts, 2 pairs sunglasses, 2 straw hats, 2 leis, 2 beach bags, 2 beach chairs.

Each team lines up in a row. Place chairs a reasonable running distance in front of each team or any distance your space will allow. The objects listed above are placed into the beach bags and located with each team. The first players on each team, put on all of the items, run to the chair, return to their team, remove the items and pass the bag to the next player. The next players continue until the entire team has had a turn.

Limbo

No tropical game time is complete without a game of Limbo. Get a long broomstick and music. 2 students hold the stick while others maneuver under it to the music. Start high and work lower and lower until the last student is the limbo champion!

Bobbing For Seashells

Fill a large plastic tub with water. Purchase floating items: plastic fish, shells, pineapples, flip flops... Before the game, use a permanent marker to write either a 1, 2, or 3 on each item. They will be placed in the water at game time. Make three prize bags filled with candy bars, gum or other inexpensive items. Write 1, 2, or 3 on each bag. Players hold their hands behind their backs and use their teeth to grab an item. They collect a prize from the bag that matches the number on the item they caught. This game can be played with any age group using simple variations on the same principle.

Tiki Tattoo Station

Set up a table with removable tattoos. Kids love putting tattoos on their faces, hands and legs. Place water in bowls along the table. Let them choose which design they like best. Buy a lot of these! Kids love having the tattoos put on them and they will wear them the rest of the day!

Pin The Monkey On The Palm Tree

Make a large laminated poster of a colorful palm tree. Make lots of small monkeys. Students are blindfolded to stick monkeys on the tree. (Ask the artists in the church to help prepare this fun game by doing the artwork!)



Isle Of Obstacle Course

Choose obstacles you have available. Here are some suggestions: Throw a ball into a basket about 10 feet away, throw bean bags into a tic-tac-toe set and get tic-tac-toe. Spin around a softball bat 3 times by placing their head on the end of it. Then search through a sandbox and find a quarter among about 5 other fake coins. There are other things you can do but we know these are funny and motivate everyone to play and to watch the others!

Puzzle Scavenger Hunt

Create clues for your game area. Players must follow each clue where they find a puzzle piece. When they found all the clues, they put the puzzle pieces together tell what it is. Some hand drawn or coloring book page puzzles can be a surfboard, palm tree, monkey, hula girl, shell, etc.

Waterfall Balloon Game

Fill small balloons with water. Students play this like the traditional egg toss. Partners line up across from each other, toss balloon from close up, back up a step, toss again. Last team with intact water balloon is the winning team.

Coconut Bowling

Roll large coconuts toward 2 liter bottles emptied of soda and filled halfway with water.

Pop The Piranha

Attach one balloon to the ankle of each player with yarn or string. The game is played when everyone tries to "pop" the balloons of other players while protecting their own balloon. Winner owns the last surviving balloon. (Caution: preschool students do not like this game. When they receive a balloon, they want to keep it. Breaking it will make them cry!)

Flamingo Ring Toss

Plastic pink yard flamingo and rings. To make unique "rings" use long balloons shaped into a circle.

Hula Hoop Contest

Purchase a few hula hoops. Players take turns trying to "hula" the longest.

Beach Ball Volleyball/Dodgeball

Blown up beach balls, net. Players play traditional volley or dodge ball.



MAUI CHOWIE BEACH HUT ALOHA SERVED HERE! ...LUAU SNACKS

*"Where The Laulau is the Kaukau at the Luau!"
(Translation: Where the leaves are the food at the feast!)*

Every great Vacation Bible School needs a memorable snack time. Visit an island beach hut where tropical snacks are served in abundance. Dress Hawaiian and decorate the "hut" for a sure 15 minute snack time winner!



BEACH HUT: If a canopy tent is available, add tables, chairs and luau decorations like colorful flowers, birds, palm trees and paper lanterns. No tent? Place picnic tables in the snack area. Or, seat students on the floor. Decorate tables with real and silk flowers and greenery. Check out ORIENTAL TRADING catalog for lots of luau decorations!

COSTUMES: Serves wear hula skirts and leis, Hawaiian shirts or muu-muu's. Place a lei on each student as they enter the Beach Hut.

MUSIC: Play Hawaiian CD's or tapes. Other tropical sound tapes are fun too! Look for sounds of ocean waves, storms and bird sounds.

SNACKS: Serve interesting, theme related snacks. This is not meant to be a full meal. Names are important so be sure to name each snack and let students practice saying the name of the food they are sampling. Browse our recipe suggestions for delicious fun and healthy tropical treats. Simplify any snack idea. Our suggestions may spark your own creativity for snacks that are available locally and in-season.

If a special event, full meal is desired, have fun creating a traditional Luau using our tips. Consider sponsoring a meal to introduce OCEAN MOTION or a grand conclusion to an exciting week in the life of your church!



Teach The Hukilau Song!
Check internet sites for sheet music or melody.

The Hukilau is an old Hawaiian way of fishing, involving casting a long net from the shore, then enlisting a large group to help pull the net to shore. Everyone in the village takes part in the fishing festival. Men, women, children all help to pull in the fish nets. Afterward there is a big Luau (feast) with singing and dancing.

The net is lined with ki (ti) leaves which help scare fish toward the middle of the net. A Hukilau was organized to rebuild a church with the congregation contributing food, talent, time and energy. Master fishermen supplied the nets. *Kahili*, the master of all fishermen, minus the three middle fingers of his right hand waved and only the thumb and little finger could be seen. This is the origin of the **shaka** sign.

Huki = pull Lau = leaves, specifically ki (ti) leaves ama ama = fish

The Hukilau Song
by Jack Owens

CHORUS: Oh we're going to a Hukilau
 A huki huki huki huki Hukilau
 Where the laulau is the kaukau at the big luau.

We throw our nets out into the sea
 And all the 'ama'ama come a-swimming to me
 Oh, we're going to a Hukilau
 A huki huki huki Hukilau.

What a beautiful day for fishing
 That old Hawaiian way
 Where the Hukilau nets are swishing
 Down in old La 'ie bay. CHORUS



TROPICAL SNACKS

“The Food is so ONO!” (ONO = good)

There are many Asians living in Hawaii so feel free to try any snack with an Asian theme. Chopsticks and fingers may be used to eat. End snacks with a Christian Fortune Cookie!

Tropical Fruit Kabobs

Skew fruits on a kabob stick for each student. Provide a small paper plate so fruit can be removed from stick without placing the stick in the mouth. Collect all sticks immediately! (Grapes, banana slices, pineapple chunks, cherry, peach, strawberry, kiwi slice)

Mandarin Orange Salad

Make orange jello with canned mandarin oranges. Use the juice at part of the liquid for the jello. Add Cool Whip topping and serve on a small piece of lettuce.

Banana Boat

Open a banana by skinning one section of the peel only. Scoop out a little of the banana and replace with miniature marshmallows and chocolate chips. Replace the peel and bake in warm oven until marshmallow and chips are melted. Serve in the skin. Eat with a spoon. This is truly delicious!

Island Softie

Push chocolate chips into the top of large marshmallows. Place in warm oven until chips are melted. Serve immediately.

Banana Split

Serve one scoop of vanilla ice topped with chocolate, strawberry and pineapple topping. Decorate with whipped cream and cherry. (Let students choose toppings as desired.)

Isle Of View Smoothie

In a blender, mix the following ingredients in this order:
4 ice cubes, 1 banana, 1 t. vanilla, orange juice to fill container. Blend until smooth and frothy. Pour into small, clear, plastic glasses. Place one cherry in each glass. Top with a paper umbrella and serve cold.

Barnacle Bay Chewies

Make your favorite chocolate chip cookie recipe. Instead of individual cookies, bake them in a sheet cake pan and cut into squares. Serve on a paper plate with a side of vanilla ice cream.



Lighthouse Pie

3 oz jello (any flavor) 3 ½ C. Cool Whip
 2/3 C. Boiling water 1 Can crushed pineapple (drained)
 2 C. Ice cubes Graham Cracker Pie Crust

Dissolve jello in boiling water, stir until dissolved. Add ice cubes and stir until jello thickens. Remove unmelted ice. Blend in Cool Whip and whip until smooth. Fold in fruit. Spoon mixture into crust. Chill three hours.

Hawaiian Wedding Cake

(This recipe is so good that you should make it for your staff even if not serving it to students—take the recipe home and make it for all your friends!)

1 yellow pudding cake mix 8 oz cream cheese
 1 can crushed pineapple 2 boxes vanilla instant pudding
 8 oz Cool Whip 2 C Milk 1 C coconut (Optional)

Bake yellow cake as directed. Drain pineapple and spread thin layer on top of baked cake. In separate bowl, mix cream cheese, milk and instant pudding. Beat until smooth. Spread on top of pineapple. Spread Cool Whip on top of pudding mixture. Garnish with coconut, if desired.

Pineapple Upside Down Cake

Use favorite recipe. This is a great dessert when asking for donations. Easy to make, easy to deliver to church on the appropriate day!

Polynesian Cookies

1 C shortening 1 t soda 1 ½ C sugar
 ½ t salt 1 egg ¼ t nutmeg 3 ½ C flour
 8 ½ oz can crushed pineapple ½ C chopped walnuts

Heat oven to 400 degrees. Mix shortening, sugar, egg. Stir in pineapple with syrup and remaining ingredients. Drop dough by teaspoonful onto ungreased baking sheet about 2" apart. Bake 8-10 minutes or until golden brown or until when lightly touches dough springs back.

OPTION: Add 1 C flaked coconut, omit nutmeg

Youcan Toucan Fluff

21 oz can cherry pie filling 14 oz condensed sweetened milk
 8 oz Cool Whip 8 oz crushed pineapple

Mix together and chill. Spring top with crushed nuts or coconut flakes



Fun Snacks

1. Watermelon, grapes, strawberries, pineapple slices
2. Sno Cones
3. Rice Pudding (Tapioca)
3. Haupia (coconut)
4. Goldfish Crackers, Oyster Crackers, Nacho Chips
5. Beverage: Hawaiian Punch!, Lemonade, spice it up with Club Soda
6. Potato Chips served in a straw beachcomber's hat

Pupu Platter

Despite its Chinese sound, the word "pupu" is Hawaiian in origin and it means relish, appetizer or hors d'oeuvre. Try a variety of snacks arranged beautifully on a large platter. Fish sticks, grilled chicken strips, slices of banana, mandarin oranges, cantaloupe, watermelon, etc. The idea is to artfully arrange the food for the "ooo-aahh" factor when it arrives at the table.

Fruit Loop Leis

Provide huge bowls of colorful Fruit Loop Cereal and brightly colored yarn or shoe strings. Students make their own "lei" from the popular cereal and get to eat it too! Make one for now and one for later!

PREVIEW PROGRAM ONLY
NOT FOR USE
PLEASE PURCHASE



SCUBA REEF TOURS ...UNDER THE SEA!

*He lawai 'a no ke kai papa 'u, he pokole ke aho;
he lawai 'a no ke kai hohonu he loa ke aho.*

A fisherman of the shallow sea uses only a short line;
a fisherman of the deep sea has a long line.

A person whose knowledge is shallow does not have much, but he whose knowledge is deep, does.
-Hawaiian Words of Wisdom

Tour SCUBA REEF fifteen minutes each day with an underwater guide who reveals information about fish, treasure and underwater life. View life from a different perspective and discover how to fit into God's plan. Where is your treasure? What is a Christian? Why should we serve God? When do we become disciples?

SCUBA REEF TOURS is an underwater tour. Turn one classroom into a sparkling sea floor. Use our suggestions to begin your adventure. Create your own visuals too!

CEILING. Loop blue and white crepe paper streamers across the ceiling to resemble ocean waves. Add paper bubbles here and there across the streamers. Attach hand drawn tropical fish hanging from fishing line.

WALLS. Hand draw large fish, octopus, and mysterious sea creatures. Add paper bubbles floating to the ceiling. Create green underwater plants with long, thin leaves. Draw a large submarine for one wall.



FLOOR. Protect floors with plastic drop cloths. Spread clean sand in the corners to make sea floor displays. Place real green plants (or silks) in the sand. Large rocks, pebbles, shells and plastic undersea creatures (see Oriental Trading catalog) add to the underwater theme.

FLOOR FAN. Place a fan in one corner turned to LOW. This gently moves the fish and plants to create simulated water motion.

LIGHTING. Darken the room. Cover windows with blue tissue paper and hand drawn fish. Light sparingly upward from the floor to make the "ocean floor" look mysterious. Black light is terrific if fish are painted in light colors. Strings of white twinkle lights hanging vertically along the walls and around the edges of the floor add mystery to the area.

MUSIC. Find a CD filled with ocean wave sounds and thunder storms. Play it as background sound throughout the activity center.

TREASURE CHEST. Place an old chest on one corner. Fill it with bottles, metal boxes and junk jewelry. Place a Bible on top and tell the students this is the best treasure.

SUNKEN SHIP. Make a sunken ship students can sit in by turning an empty appliance box on its' side. Cut round port holes on both sides. Spray paint the box black, copper and silver.

COSTUME. Wear a scuba suit and pretend to swim along the ocean floor. Underwater masks, tanks and flippers along with a bathing suit work well. Become a knowledgeable tour guide leading students on an exciting adventure.

STUDENT MASKS. This is an enjoyable option. Purchase inexpensive swimming masks/goggles at the dollar store. Buy only enough for the largest group. Take group pictures while wearing goggles.

A different short lesson is taught daily.
Have fun with the area and enjoy the activities.
The kids will never forget it!



SCUBA REEF TOURS DAILY TOUR GUIDES

MONDAY

...HOW DEEP IS YOUR LOVE FOR GOD?



GREET STUDENT GROUP OUTSIDE THE AREA: Welcome to a unique under water OCEAN MOTION experience. I am your scuba guide. I will escort you to a depth of 200 feet to the ocean floor. As you enter Scuba Reef, we request no eating, no drinking and no flash photography.

Welcome to a place where light and air do not exist. The creatures are water loving and dependent upon the vegetation for their existence. Our trips under the sea will answer a few questions about being a Jesus Disciple.

ESCORT STUDENTS INTO THE SCUBA REEF ROOM.
PRETEND TO SWIM AROUND THE ROOM, INVESTIGATING CREATURES
ON THE WALLS AND FLOOR. SEAT THE GROUP ON THE SEA FLOOR.

HOW DEEP IS THE OCEAN? Would you like to get into a submarine and travel to that deep section? Oh sure, you say yes now, but it is a dangerous journey. Located near the Philippine Islands, the bottom of the sea is seven miles beneath the surface. (35,800 feet)

Jacques Piccard and Don Walsh took this journey in 1960. Their special submarine is called a BATHYSCAPH. For fifteen minutes they saw what no one has ever seen and lived to tell the tale. When the sub began squeaking, they hurried to the surface and no one has ever dared do it again.

Someday people may walk on the ocean floor but suits and ships needed are more than our scientists can invent today. Underwater cameras do the work, sending amazing pictures of life deep in the dark.



DEEP WATER FISH have little lights on their foreheads like coal miner hats. How do these fish live under such pressure? Their skin is so thin we can see through them. The ocean may be deep and dark but it is loud! Microphones pick up chatter and clicking noises that seem to be some kind of "fish talk".

DID YOU KNOW THAT GOD BEGAN HIS CREATION OF EARTH WITH WATER? Peter said,

"...long ago by God's Word the heavens existed and the earth was formed out of water and with water."

II Peter 3:5 NIV

PRINT THIS PORTION OF II PETER 3:5 ON A PAPER FISH SHAPE AND SEND IT "SWIMMING" ON THE WALL AS YOU SAY THE VERSE.

HOW DEEP IS GOD'S LOVE FOR YOU? Let's begin at the beginning! God loves you so much that He would rather die than live without you. He thinks you are terrific! To show you how wonderful you are, God sent Jesus, His Only Son, to live on earth and die for you and me.

"For God so LOVED the world (that's you) that He gave His only begotten Son so that whosoever (that's you) believes in Him, should not perish but have everlasting life." John 3:16 KJV

With love that deep, how can we resist? You must believe God's Word and trust that the message of God's deep love is true.

Just look at the ocean floor to know how deep God's love is for us! He takes care of details and surprises us with in His creation. It is amazing that God is God and is also our Heavenly Father who knows us personally.

HOW DEEP IS YOUR LIVE FOR GOD? To make your love for God deeper: *Print the 4 lessons on paper fish. Ask the group to say each one aloud until they remember each one.*

1. READ GOD'S WORD EVERY DAY
2. PRAY-TALK TO GOD ABOUT EVERYTHING
3. GO TO SUNDAY SCHOOL AND CHURCH
4. KEEP GROWING IN YOUR FAITH



DAY #1 ACTIVITY:

WATER BOBBING

Place items in a tub of water where students dive "deep" to capture a prize. Young students may "dive" with one hand to catch their prize.

Place a plastic drop cloth on the floor and provide towels. Oriental Trading Catalog sells vinyl fish that float in water. www.orientaltrading.com

Apples may be used as in a traditional bobbing game.

PREVIEW PROGRAM ONLY
NOT FOR USE
PLEASE PURCHASE



TUESDAY
...WHAT HAPPENS TO MY SIN?



GREET STUDENT GROUP OUTSIDE THE AREA: Welcome to SCUBA REEF TOURS, a unique underwater OCEAN MOTION experience. I am your scuba guide. I will escort you to a depth of 200 feet to the ocean floor. As you enter Scuba Reef, we request no eating, no drinking and no flash photography. As always, we hope you enjoy your day at Scuba Reef.

ESCORT STUDENTS INTO THE SCUBA REEF ROOM.
PRETEND AN EARTHQUAKE IS SHAKING THE AREA.

EARTHQUAKE! Wow, who would have thought an earthquake would hit under the ocean just when you are touring? It seems to be calming down so before there are aftershocks, let's talk about it.

A long time ago (1692) an earthquake shook an entire city into the ocean. It hit Port Royal, Jamaica on June 7 at 11:43 AM. A tidal wave followed and tons of water pulled the whole town to the bottom of the sea.

Sometimes nature gets out of control and hurts people. Two thousand people died. It is one of the few cases in history where a city was thrown into the ocean all at once. Divers have enjoyed searching the remains of Port Royal. They discover gold, silver, bottles, cannons and even an old watch. They noticed the hands stopped at exactly 11:43—earthquake time!

SHIPWRECKS! Searching for sunken treasure is dangerous and expensive. Divers love the search and are often rewarded with amazing finds. The famous ship Titanic was found by determined divers who took risks to find it. Peter Throckmorton discovered a ship in 1960 under 85 feet of water. It dated 1000 years before Jesus. Coins found in the ship had the date stamped clearly.

People are not the only treasure hunters under the ocean. The best treasure hunters are fish. They swallow license plates, boots, watches and silver cups. There are more valuable treasures underwater as well. Sometimes submarines get stuck and cannot pull free of the mud. When that happens lives are lost. The ocean is so wide and deep that it holds many priceless treasures.



The prophet Micah in the Old Testament gave us a picture of how God forgives our sins. He said it's like God threw our sins in the ocean and forgot about them.

PRINT MICAH 7:19 ON A PAPER FISH SHAPE
AND SEND IT "SWIMMING" ON THE WALL AS YOU SAY THE VERSE.

"You will tread our sins beneath your feet;
You will throw them into the depths of the ocean."
Micah 7:19 TLB

DAY #2 ACTIVITY:

CATCH A FISH!

Give each player a small fish net purchased at a local store. Everyone tries to catch small fish (plastic or goldfish crackers) in their net. Leader stands at one end of Scuba Reef and tosses a few fish at a time in the air. Students scramble to catch one in their net. Lob high in the air to give players time to catch one.

Note: Purchase enough nets for one small group. Each group uses the same nets. If desired, buy 10 nets and divide the group into teams.



WEDNESDAY ...FOLLOWING JESUS



GREET STUDENT GROUP OUTSIDE THE AREA: We are your scuba guides. FOLLOW us to the Ocean Motion floor at a depth of 200 feet. As always, we request no eating, no drinking and no flash photography. Enjoy your tour!

ESCORT STUDENTS INTO THE SCUBA REEF ROOM.
SEAT THE GROUP ON THE FLOOR.

ARCHER FISH: There are thousands of types of fish in the Ocean. Some are suited to cold water and some enjoy warm water. Some are huge and others are tiny. Today we are going to learn about a talented fish. It is the Archer Fish, often called the Target Fish.

This is a tricky fish. When looking for dinner, the Archer lifts it's head out of the water and spits water fifteen feet. It can hit a ladybug on a tree at six feet. Bug falls into water and-dinner!

Most Archer fish live their lives in the deep ocean and never use their amazing talent. Others live close to land and spit water all the time. It's fun to watch them in a tank. People stick hamburger to the sides and watch the fish shoot the meat off the side.

To be a good spitter, the Archer fish must overcome problems:

- 1. EYESIGHT!** Can you believe that it lives so deep in the water, it does not see clearly in the light of day.
- 2. SPITTING!** It takes a lot of air pressure to spit fifteen feet. The fish has to trap water in its' gills and with great power force the water out his mouth. The tongue forms a tunnel to help aim at the target.

BABY ARCHER FISH try to shoot water but they are not good at it. They do not have enough pressure to spit and their aim is terrible! They have to practice over and over to spit accurately. Pretty soon they become skilled enough to catch their dinner. Not even all grown up Archer fish are good. It depends on how much they practice as to how well they eat!



HOW DO WE BECOME FOLLOWERS OF JESUS? Practice! When we learn any new skill we do not do it well unless we practice. The more we do it, the better we become. A smart mom and dad help their child practice being good. The more we choose to love Jesus, be kind, share, be gentle or forgive other, the easier it is to do.

PRINT PROVERBS 22:6 ON A PAPER FISH SHAPE
AND SEND IT "SWIMMING" NEAR YESTERDAY'S VERSE.

TRAIN UP A CHILD IN THE WAY HE SHOULD GO
AND WHEN HE IS OLD, HE WILL NOT DEPART FROM IT.
PROVERBS 22:6 KJV

DAY #3 ACTIVITY: SEED SPITTING CONTEST

Place one long sheet of white shelf/freezer paper on SCUBA REEF floor. Give watermelon slices so students can "fish" for their own seeds. Each participant spits their seeds as far as possible along the paper. Reward the winners with goldfish crackers or gummy fish!

OPTION: BEAN BAG TOSS

Make or purchase bean bags in fish shapes. Or use fish shaped plastic toys to toss through a homemade version of a toss game. Draw a large fish on cardboard with hole where open mouth should be and let students toss their "fish" into the mouth. Increase distance for older players.

Fish toys may be purchased from Oriental Trading Catalog,
www.orientaltrading.com



THURSDAY ...HOW CAN I PLEASE GOD?



GREET STUDENT GROUP OUTSIDE THE AREA: Welcome to SCUBA REEF TOURS, a unique underwater OCEAN MOTION experience. I am your scuba guide. I will escort you to a depth of 200 feet to the ocean floor. As you enter Scuba Reef, we request no eating, no drinking and no flash photography. As always, we hope you enjoy your day at Scuba Reef.

ESCORT STUDENTS INTO THE SCUBA REEF ROOM.
PRETEND AN EARTHQUAKE IS SHAKING THE AREA.
STUDENTS MAY JOIN IN ON THE "SHAKING" FUN!

AND THE QUESTION IS...? Today's Scuba Reef question is "How can I please God?" Any ideas? *(Let students answer.)* Those are very excellent suggestions. When we become followers of God, we naturally want to please Him. God is really pleased when we trust Jesus as our Savior but there is one more way we can make God smile!

WATER, WATER, EVERYWHERE! The earth holds lots of water underground. Even the ocean has underground fountains of water. We usually see fountains springing up above ground. The most famous natural fountain is Old Faithful in Yellowstone National Park. It is a geyser that shoots water 120 feet in the air every hour. People travel from all over the world to see it and they are never disappointed.

Underground water comes from melting snow and mountain streams. Some underground water is like a teakettle. It is so hot it just has to let off steam. Scientists keep learning about hot water under the earth. They even figured out ways of using that hot water to heat homes and run factories.

The whole city of Reykjavick Iceland sits on top of hot springs. They heat their homes and run their factories using that boiling water. They are very clever people! People love to swim in hot water from places like Hot Springs, Arkansas and Saratoga Springs, New York. When muscles ache, there's nothing like soothing hot water to please the aching person. Some people claim their aches and pains go away when they swim in the hot springs.



Hot underground water is a wonderful gift from God. We don't think about it very often but King David thought about God's hot water gift. He said,

"**Praise Him** who planted the waters within the earth, for His loving kindness continues forever." Psalm 136.6

Did you catch that? Let's hear it again...(read Psalm 136:6) The answer to today's Scuba Reef question is.....Praise Him!!!

God loves it when we say thanks for all the amazing gifts He has given us. Praising God means saying "Thank You, Lord, for all You've done. You always take care of me."

Give thanks with a grateful heart and you will have pleased God. Now see? That question was not so hard to answer after all!

Follow me to a special spot just outside Scuba Reef. I think you are going to enjoy the "fountains" of water we are going to create to remind us about pleasing God. Are you ready to get wet? Let's go!

DAY #4 ACTIVITY: WATER PISTOL RELAY

This is definitely an outdoor activity but popular and fun! Fill plastic water pistols or large water pump guns. Divide the activity center group into two teams. Each team must fill containers placed at the far end of the course by squirting water from a distance.

After each team has shot, measure the water in the team jars. Winning team will have the most water. Repeat as desired. Fill large plastic containers with water at each starting line so there is plenty of water resource.

OPTION: If water pistols are not available, fill plastic cups with water from plastic containers placed on the ground. Each team member fills cup, runs, dumps and returns to starting line. The challenge is that each cup has holes in the edges which makes keeping water inside difficult. Teams must run the length of the course as fast as possible, dump their water, get back to the starting line so the next person can fill, run and dump.



FRIDAY ...WHERE IS YOUR TREASURE?



GREET STUDENT GROUP OUTSIDE THE AREA: Welcome to SCUBA REEF TOURS, a unique underwater OCEAN MOTION experience. I am your scuba guide. I will escort you to a depth of 200 feet to the ocean floor. As you enter Scuba Reef, we request no eating, no drinking and no flash photography. As always, we hope you enjoy your day at Scuba Reef.

ESCORT STUDENTS INTO THE SCUBA REEF ROOM.

Where is your treasure? What is important in your life? (*Family, School, Church, Friends, Stuff, Money, God*) Sometimes we choose good treasures and other times we choose treasures that hurt us. All treasure looks good when you find it but let's face it...there's a lot of junk out there!

One great treasure is can be found by prying open an oyster. Pearl Divers find oysters that hide their treasures deep inside their shells. The most famous divers are Japanese women who team dive off the coast of Japan. The best pearl diving happens in the Persian Gulf were two men usually dive together. One man stays in the boat and the other man looks for pearls. The diver drops 100 feet and fills a basket full of shells for one minute. The man in the boat pulls the basket to the surface. This is a dangerous career. People who dive, practice holding their breath and dive a few feet at a time to build lung strength.

I bet you think pearls are white. That is true but pearls come in pink, black, bronze, brown, green and blue. The most expensive pearls are black. Pearls are the only gems taken from the ocean and it is also the only gem made by a living creature—the oyster.

Pearls begin as a grain of sand inside the shell. The oyster is bothered by the sand and covers it with a milky substance. Layer after layer, the sand is covered and becomes a beautiful pearl. Sometimes the pearl is round and sometimes it is shaped oddly like an oval or a blob.



If pearl diving isn't for you, start a pearl farm. Farmers keep a seabed of shells and insert grains of sand to get the pearls started. After seven years, the pearls are ready to open. One out of twenty shells holds a usable pearl.

People have loved pearls long before the birth of Jesus. Job thought about all the foolish things people do. Picking bad friends, getting into trouble....sometimes children do the exact opposite of what their parents tell them and a few break the law. Job thought it would be better to take time to think before acting badly. Look at what Job said:

Yes, the price of wisdom
is above pearls.

Job 28:18 KJV

PRINT THESE WORDS ON A PAPER FISH or OYSTER
AND SEND IT "SWIMMING ON THE WALL."

DAY #5 ACTIVITY: PEARL DIVING

Purchase large "pearls" from a craft catalog or in a craft store. Hide the pearls in a mound of sand or in a basket filled with white packing peanuts. Students search for them with their hands. Those who find a lot of pearls may share or stress that each player may find up to a certain number so everyone can find at least one pearl.

OPTION: Another way of hiding the pearls is to place one large "pearl" inside a plastic Easter egg. Hide the eggs in a large container filled with packing peanuts. Players dive into the peanuts to find one egg and its' treasure.

Players may trade in their pearls for a treat offered in baskets. The treat may be something good to eat or something to take home and keep.



SCUBA REEF CRAFT OPTIONS



If the daily activity suggestions will not work in your situation, consider completing simple craft projects each day. The fifteen minute time period moves quickly so choose an easy project. Here are a few fun suggestions from S&S Arts and Crafts catalog and their website: www.ssw.com Prices may change.

JESUS FISH CARD. Be the messenger of Christ's love when you decorate this precut fish card. Color with markers included. 11: x 5". CHG-RE495 \$12.99 per pack of 24. 54 cents per project.

ON A FISHIN' MISSION. This colorful project issues the challenge of Jesus from Matthew 4:19 "Follow Me and I will make you fishers of men." 5 ½" x 6". CHG-RE437 \$9.99 per pack of 24. 42 cents per project.

AQUARIUM LIFE. Bring a bit of the ocean indoors! Easy to put together with precut foam aquarium and fish, chenille stems and more. 8 ½" x 5 7/8" CHG-CE4034 \$9.99 per pack of 12. 83 cents per project.

TROPICAL FISH MOSAIC. Add a touch of the colorful tropics anywhere with these fishy foam friends! 8" x 5" CHG-CE4042 \$7.99 per pack of 12. 67 cents per project.

FISH BEADS. These fun, chunky beads are easy to string, fun to wear and come in assorted bright colors. Mix with other beads for a unique look. Approximately 1 ½" long. 50 pieces per pack. CHG-BE913 \$8.99 per pack

COLORING PLACE MATS. OCEANS-These preprinted place mat sets feature bold lines and large coloring spaces to increase success. Brief, informative poems fill the edges. Color with crayons, markers or coloring pencils (sold separately). May be laminated for long life. Set includes 2 each of 5 different ocean designs. CHG-GA2701 \$7.49 per set of 10.



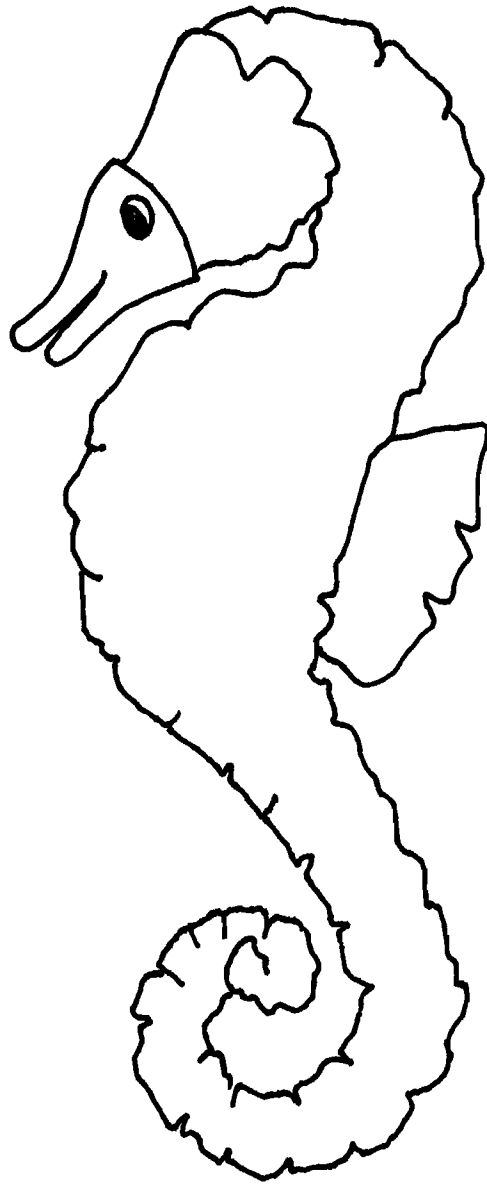

ISLAND BIBLE PORTS OF CALL TIPS FOR TEACHERS

Aloha kakou!
(Greetings between you and I)

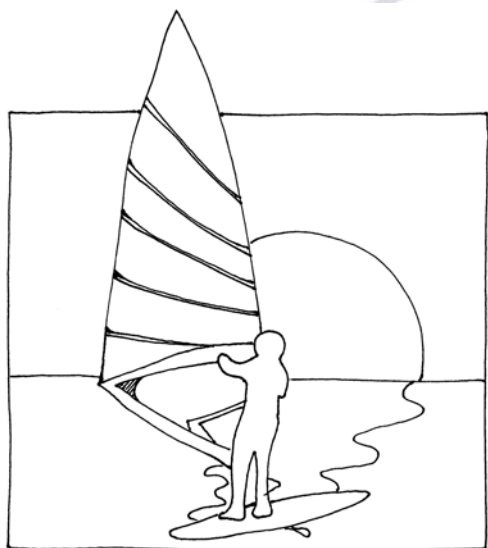

Each OCEAN MOTION Island Bible Workshop represents a fun tropical island *port of call* where students learn how to become followers of Jesus. Small groups explore island life, memorize a scripture verse, hear a Bible story and complete a craft project.

Island Bible Port of Call leaders accompany their day group and serve as extra help in all daily activity centers. Decorations, costumes and relationship bring this appealing tropical theme to life. Lead your students on a fun trip to the islands where lives are changed forever.

ISLAND BIBLE PORT OF CALL #1:

COME TO JESUS!

Memory Verse: If any man is thirsty, let him come to Me and drink. John 7:37

Bible Story: Well Water-Samaritan Woman at the Well John 4:5-42

Craft

ISLE OF VIEW

ISLAND BIBLE PORT OF CALL #2:

GROW IN JESUS!

Memory Verse: Jesus said, "I have come that they may have life...." John 10:10

Bible Story: Walking On Water Matthew 14:22-33

Craft

HOW ARE YA ISLAND

ISLAND BIBLE PORT OF CALL #3:

FOLLOW JESUS!

Memory Verse: Follow Me and I will make you fishers of men. Matthew 4:19

Bible Story: Fishing Water Matthew 4:18-22

Craft

BARNACLE BAY SHIPWRECK



ISLAND BIBLE PORT OF CALL #4: YOU CAN TOUCAN ISLAND

GROW IN JESUS!

Memory Verse: Thy Word have I hid in my heart....Psalm 119:11

Bible Story: Calm Waters Mark 4-35-41

Craft

ISLAND BIBLE PORT OF CALL #5: THE LIGHTHOUSE

SHINE JESUS SHINE!

TEACH OTHERS ABOUT JESUS!

Memory Verse: And the things you have heard from me

...tell faithful men...II Timothy 2:2

Bible Story: River Water–Baptism of Jesus Matthew 3:13-17

Craft

DECORATE: Follow our decorating suggestions or design your own colorful tropical retreats within your workshop space. Borrow items from friends and family and church folks. Make decorations from construction paper, posterboard and cardboard. Create dramatic lighting with white twinkle lights, floor spots and darkness. Use the internet to find lovely, inexpensive accessories. Catalogs also offer many luau decorations that work perfectly for this program.

COSTUME AND CHARACTER: Follow curriculum suggestions. Borrow, rent or make simple island costumes.

MEMORY VERSE ACTIVITY: Teach the scripture verse for each workshop. If you prefer another teaching activity, use your own idea. Shorten the verse to match the age group.

ISLAND BIBLE WORKSHOP STORY: The Bible theme is WATER STORIES and show students what it takes to be a disciple of Jesus. Ask questions to encourage active involvement. Simplify material for younger students. Older students may participate in discussion and reading where appropriate.

TIME MANAGEMENT: Small groups complete their workshop activities in one session. Each Island Bible Workshop leader sees a new group of students each day. By the end of the week, all five groups will have visited each workshop. If suggested activities cannot be completed within the forty five minutes allotted, choose the most important details and leave the rest.



ISLAND BIBLE PORT OF CALL CRAFT SUGGESTIONS

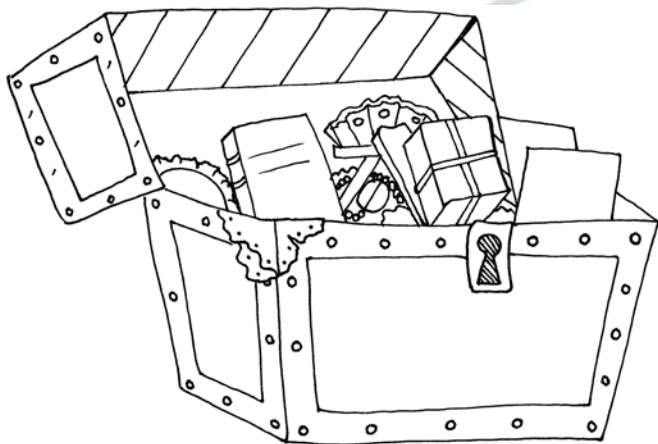

Each OCEAN MOTION Island Bible Port of Call includes craft activity time. Choose crafts from the following list. CLOSE ENCOUNTERS MINISTRIES is pleased to offer suggestions from two excellent companies. We include catalog information and website addresses. PRICES MAY CHANGE!

Homemade projects are fun and inexpensive. Your local crafty folks may create five separate projects and gather materials. If any other appropriate Island theme project appeals to any teacher, develop that project.

Set up one corner of each ISLAND BIBLE PORT OF CALL to complete a simple keepsake. Divide craft parts into kits. Helpers assist young students. Students not attending Open House may take their completed projects home any time.

S&S ARTS AND CRAFTS

www.ssw.com Call for Catalog 1-800-243-9232

SHELL FRAMES. Show off a favorite picture. Includes frames with easel backs, assorted natural shells, gold and silver acrylic paint, non toxic glue, and metallic paint, brushes and instructions. 2 1/4" x 3 1/4"

GP931 (Pack of 18) \$19.99 Only \$1.11 per project. (3 Or more-\$17.99)

SHELL CROSS NECKLACE. The cross is the sign of god's love for us. Enjoy making one of a kind crosses and wearing this special symbol. Includes a variety of attractive shells, gold cord, plywood crosses, non toxic glue and instructions. 2 1/4" x 3". Pack of 16.

RE201 \$14.99. Only 94 cents per project



REFLECTIVE SEASCAPES. Pack includes self adhesive cardboard squares, assorted shells and fine sand. 3" square acrylic mirrors, non toxic glue, iridescent glitter and instructions. Adult supervision required to cut with craft knife before students work. GP1251 (Pack of 24) \$34.99. \$1.46 per project. (3 or more \$33.29)

SHELL TREASURE BOXES. Includes craft board boxes, assorted shells, acrylic paint, glue, brushes, sand and instructions. Measures 3 1/4" x 3 1/4" x 2 1/4". (Pack of 24) GP993 \$24.99. \$2.04 per project

EXOTIC BEADED NECKLACES. A treasure chest full of exotic beads to create one of a kind necklaces. Comes complete with assorted beads, wire and instructions. GP930 (Pack of 30) \$23.89. 80 cents per project

SHELL CROSSES. Colorful shells are glued to wooden crosses, then painted with gold or silver paint if desired. Includes wooden crosses, assorted shells, non toxic acrylic paint and glue, brushes, sandpaper and instructions. 5" X 8" RE256 (Pack of 24) \$20.99 87 cents per projects

SAND CROSSES. It's so easy to create these beautiful cross pendants. Just peel the backing off the precut cross, sprinkle with sand in your own design and then string on a black cord to wear. Pack contains precut self adhesive cross shapes, ultra fine glitter sand, black cord and instructions. (Pack of 48) RE337 \$23.99 50 cents per project

SHELL CROSS BOXES. Easy to assemble, precut, cross shaped boxes are fun to decorate with assorted shells and metallic gold and copper paint. Great for keeping jewelry, coins and prayers. Comes complete with shells, non toxic paint and glue, brushes, craftboard boxes and instructions. 3" x 5 1/2". (Pack of 24) RE279 \$24.99 \$1.04 per project

JESUS IS MY TREASURE CHEST. Kit includes craft sticks, corkboard pieces, wooden beads, gold ribbons, novelty jewels and instructions. All you need is glue. 4 1/2" L x 4" H x 3" D when assembled. (Pack of 12). RE496 \$12.99 \$1.08 per project

SEA LIFE SAND ART BOARDS. Underwater scenes include whales, dolphins, turtles and fish—3 each of the 4 designs, 12 per pack. Simply peel away precut shapes off the boards to expose a self stick surface. Then apply fine sand for stunning artwork. SP3970 \$9.99 per pack.



Guildcraft arts and crafts

www.Guildcraftinc.com

800-345-5563

FISH WINDSOCKS. Includes preprinted white cardboard bodies, wiggle eyes, streamers, ribbon and glue. Decorate with markers or paint (sold separately). Finished projects are 12 ½" x 8 ½" with 20" tails. (24 projects) 217-128 \$36.95

SILLY SHELLS. Make your own sea creatures! Includes sea shells (1/4" to 2") in assorted shapes, wiggle eyes, feathers and glue. (35 projects) 817-002 \$9.95

SEA LIFE WEAVING MATS. Precut, pre slit, colored cardboard is easy for little fingers to manipulate. Includes 6 each of 4 shapes (6" x 10"), colorful paper strips and an idea guide. (24 projects) 216-225 \$6.99

SEA SCAPE PLASTER HANGINGS. Bring the beach inside with these easy to make, plaster wall hangings,. Includes plaster, sea shells, sand (assorted colors), ribbon and foam trays, 4 ½" square. (15 projects) 681-048 \$17.85

SEA LIFE SUNCATCHERS. Simply brush the glass stain into each area and let dry to create these whimsical suncatchers. Includes assorted suncatchers (plastic), glass stains and brushes. 2 ½" x 3 ½" (24 projects) 581-973 \$17.45

CARDBOARD LIGHTHOUSES. Make and decorate your very own lighthouse! Includes prepunched, cardboard lighthouses, paint and brushes. 10 ½" tall (12 projects) 217-143 \$24.75

FOAMIES LEI NECKLACES. String your own colorful lei. Includes precut foam pieces and string. 18" long. (8 projects) 353-928 \$7.99

WAY COOL SUNGLASSES. Fun to wear (and totally cool) shades in assorted neon colors, complete with a beaded strap. Includes plastic sunglasses, pony beads and precut cord. (12 projects) 920-365 \$13.99

ALOHA BRACELETS. A friendly Hawaiian greeting! Includes beads and elastic. (30 projects) 401-015 \$15.85



ISLAND PORT OF CALL #1

ISLE OF VIEW

...COME TO JESUS!

DECORATION: This Bible Workshop represents a tropical island. Follow general curriculum guidelines. Palm trees, sand, shells, water, green plants, sailboat and other beach items look great in this area. Bright light is appropriate as well as a fan set low to simulate gentle breezes. Play ocean sounds from a CD purchased at a local store. Print the island name ISLE OF VIEW on an old piece of wood or on green paper palm leaves.



COSTUME AND CHARACTER: Follow general curriculum guidelines for costume ideas. Your character is a friendly Island native greeting everyone with "Aloha".

ISLE OF VIEW WELCOME: Aloha! Welcome to Isle of View. Does the name of my island sound like another phrase you know well? (I Love You!) At ISLE OF VIEW you will enjoy tropical breezes, find out how to "Come to Jesus" and test your skills making a fun keepsake to take home! Together, we will discover that when Jesus says, "I love you", we are loved forever.

Aloha nui loa means "with much love" or "warm greetings". Say it aloud with me to remind you of your visit to my island home. (Practice saying the phrase with the group. *Ah-low-ha new-ee low-ah*)

ISLE OF VIEW MEMORY VERSE

*Jesus said, "If any man is thirsty, let him come to Me and drink."
John 7:37*

Provide small cups of icy cold water for each student. Before they drink their cup of water, say the verse aloud several times. Once everyone can say it, let them enjoy their refreshing drink.



ISLE OF VIEW BIBLE STORY:

WELL WATER

John 4:5-42: Nothing tastes better on a hot day than icy, cold water. It fills your mouth with freshness. Your whole body feels better. That is exactly how "coming to Jesus" makes you feel. God forgives sin...you cannot get more refreshing than that. You might not think you sin (*do anything wrong*) but God's Word reminds us, "All have sinned and fall short of the glory of God" (Romans 3:23). Even if you are a kid, sin affects your young life.

A Samaritan woman went to the well outside her town of Samaria to get a jug of water. Instead, she had a "Come To Jesus" moment and got much more! Jesus "washed away" her sins!

The Samaritan of our story was a lowly woman. No one liked her and she had to get water from the well in the heat of the day to stay away from others who bothered her. Most people napped in the heat of the day and nobody in their right mind got water then. But she did.

Jesus didn't normally travel in Samaria but on that day He comes upon the well where He meets the Samaritan woman and asks her for a drink of water. She is amazed when this Jewish man asks her, a Samaritan woman, for a drink.

Jesus doesn't laugh at her surprise. He tells her about the living water God proves that gives eternal life. This woman is thirsty for living water. Not so fast, woman! Jesus makes her understand she needs to confess her sins and change her life before she can get this life water. Jesus knows all about her life. This woman at the well is no angel. Mixed up with the wrong crowd, this poor woman from Samaria has quite a reputation. She must change.

She says, "I know Messiah is coming. When he gets here, he will tell us about these things." Jesus looks in her eyes and says, "I'm that guy! I am Messiah, the one speaking to you."

Now this Samaritan woman has a choice. She can believe Jesus and come to Him or she can say, "No way! You cannot possible be Messiah." What do you think she does?



She comes to Jesus! She believes He is truly Messiah, God's Son. Jesus IS the Living Water! She asks forgiveness of her sin and that's not all! She runs back to tell her family, friends and neighbors how she met Jesus and how He revealed her sins. She told them about this life giving "living water" which brings eternal life. Jesus took a couple of days to live in that little town. Lots of people came to Jesus there because of her faith, the faith of a lowly unloved woman.

We never hear about the Samaritan Woman again but we know her story. This woman came to Jesus. She was thirsty for God's answer to life. She drank from the well of God's "Living Water"! And we can do the same thing.

ISLE OF VIEW LESSONS

Print theme words on glasses of water.

1. COME! Jesus gives us a simple invitation. One word. Just "come". Does come mean you have to be perfect? Rich? Smart? No, "come" means "come just as you are."

Jesus said, "Here I am! I stand at the door and knock. If anyone hears my voice and opens the door, I will COME in and eat with him and he with me." Rev. 3:20

2. KNOW! You alone, no matter how young or old, must think, "Hey, I'm like the Samaritan Woman at the well! I do things that make God sad. I need living water."

3. CONFESS! Not one kid likes to think they are sinners. Sinners are really bad guys who steal money from the bank, kill people and hurt others but they are not the only sinners. You and I are sinners too! Don't forget God says, "For ALL have sinned and fall short of the glory of God." (Romans 3:23) Not to worry! The same plan Jesus gave the Samaritan woman is for us too!

4. ACCEPT! Believe that Jesus is our Savior. COME TO JESUS! "If you confess with your mouth 'Jesus is Lord' and believe in your heart that God raised him from the dead, you will be saved." Romans 10:9

COME TO JESUS isn't just a nice theme for ISLE OF VIEW, it has been God's theme throughout history. Want to get to heaven? God's plan is accept Jesus and make Him the Lord of your life.



Prayer: *Dear Lord Jesus, Forgive my sin. COME into my life and make me Your child. I love You and I will serve you like the Samaritan Woman at the well. I want to be in Your family. In Jesus' Name, Amen!*

CLOSE IN PRAYER

CRAFT

Choose a project from the list or design your own craft keepsake to remind students to COME TO JESUS.

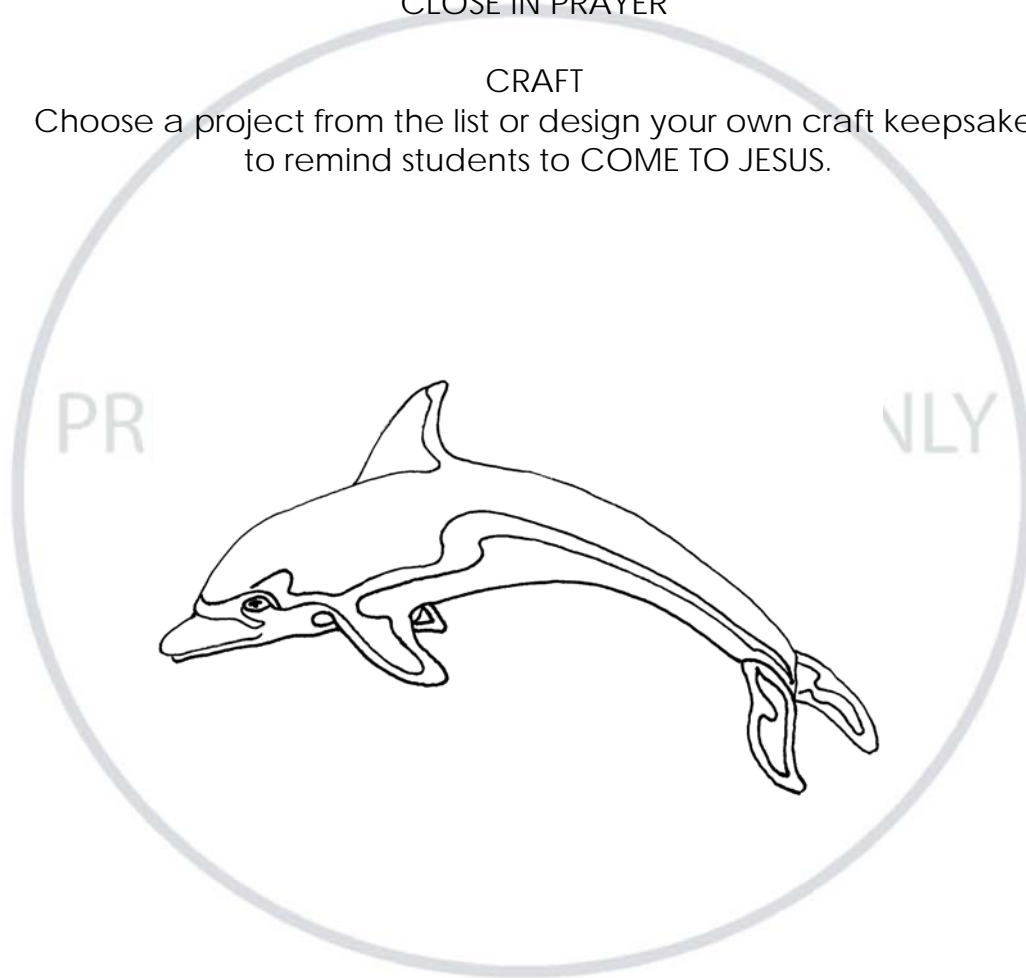

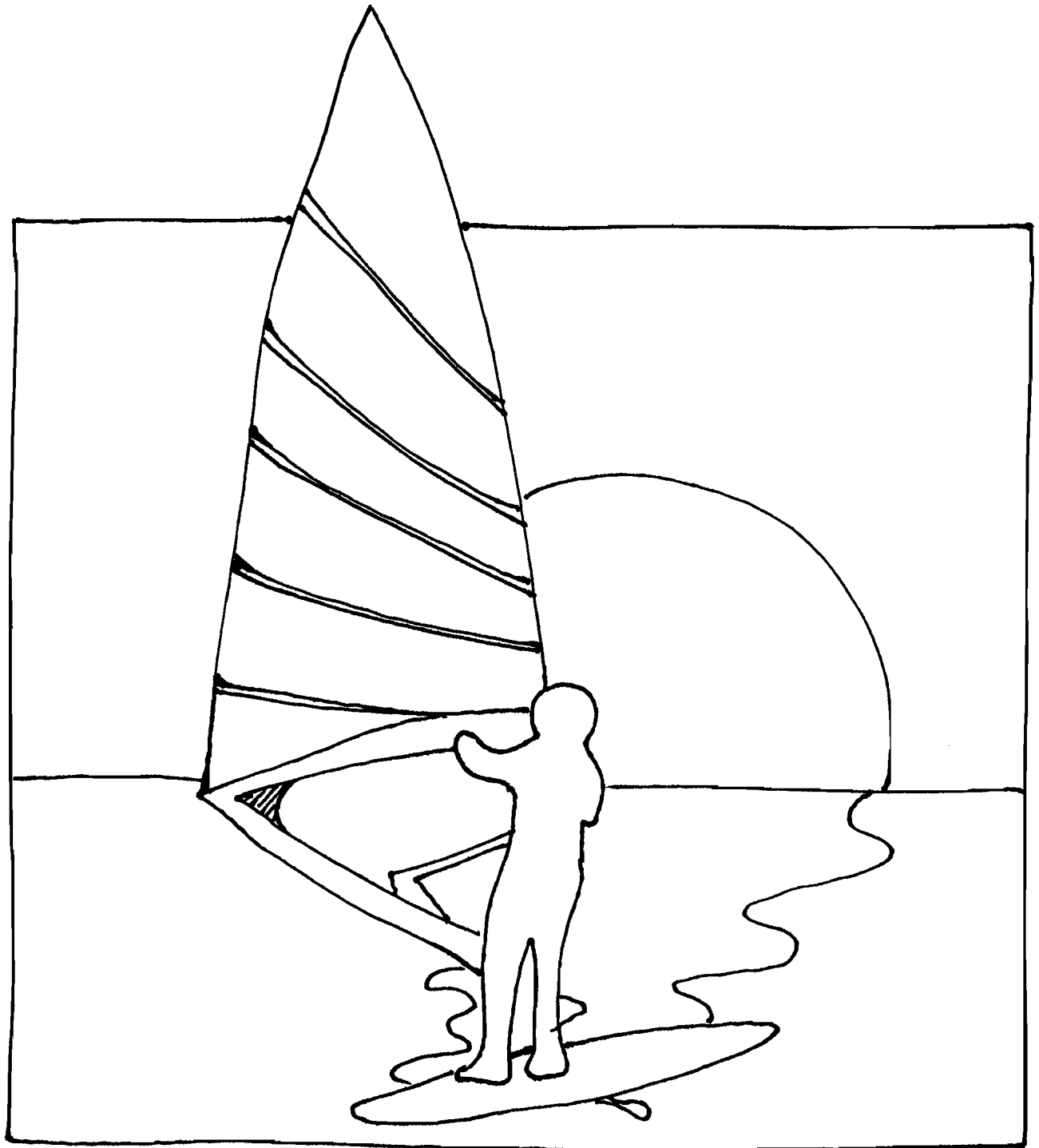

ISLAND PORT OF CALL #2:

HOW ARE YA' ISLANDS ...GROW IN JESUS!

DECORATION: This Bible Workshop represents a tropical island. Follow general curriculum guidelines. Palm trees, sand, shells, water, green plants, sailboat and other beach items look great in this area. Bright light is appropriate as well as a fan set low to simulate gentle breezes. Play ocean sounds from a CD purchased at a local store. Print HOW ARE YA' ISLANDS on an old piece of wood or green paper palm leaves.



COSTUME AND CHARACTER: Follow general curriculum guidelines for costume ideas. Your character is a friendly island native greeting everyone with "Aloha".

HOW ARE YA' ISLANDS WELCOME: Aloha! We have been waiting for you on our friendly tropical island. Once you come, you will never be a stranger. You will learn how to GROW IN JESUS here. Relax and enjoy your visit to our friendly island spot. Growing in Jesus is fun and makes us better followers of Him.

Aloha kakou means "greetings between you and I". Say it aloud with me to remind you of your visit to my island home. (Practice saying the phrase with the group. *Ah-low-ha kay-kow*)

HOW ARE YA' ISLANDS MEMORY VERSE

*Jesus said,
"I have come that they may have life,
and that they may have it more abundantly."
John 10:10*

Make large green construction paper palm tree leaves with verse phrases printed on separate leaves. The students "grow" a palm tree as they memorize the verse. As they say each phrase, they place it on a brown paper palm tree trunk already in position on one wall.



BIBLE WATER STORY:

WALKING ON WATER

Matthew 14:22-33: Can you walk on water? Not ice, real water! People have figured out ways to float on water using inner tubes and boats that float but no one, except Jesus, has ever walked on top of water.

One evening Jesus was tired and wanted to be alone. He told his friends to sail their small boat across the Sea of Galilee without Him. The wind began to blow and the boat was tossed in the waves. The disciples were afraid! It must have been an awful storm because several of the men were fishermen. Storms don't scare fishermen.

Suddenly they saw Jesus! Right there in the middle of the sea. He was walking on the waves toward their boat. The men were so afraid they shouted, "It's a ghost!" Jesus called back, "Don't be afraid! It's me!"

When the disciples knew Jesus was actually walking on top of the water, they knew they were seeing a miracle. Peter shouted, "Hey, if it is really you, let me walk on water too!" Jesus said, "Ok Peter, come out of the boat." Jesus may not have been pleased but He was willing to let Peter experience a miracle.

Peter did just fine as he stepped out of the boat and onto the raging water. I wonder if it was a neat feeling of cool water, wind and spray hitting his face and his feet. He didn't sink—awesome!

And then, Peter forgot that Jesus was in control. He heard the wind, saw the dark night and was suddenly afraid. He looked around at the danger and he took his eyes off Jesus. Right away, Peter began to sink into the waves. He shouted, "Lord, save me!" Jesus reached out and grabbed his hand.

A disappointed Jesus said, "O man of little faith. Why did you begin to have doubts?" As soon as Jesus and Peter stepped into the boat, the wind stopped. The rest of the men in the boat bowed before Jesus and said, "It's true! You are the Son of God!"



HOW ARE YA' ISLAND LESSONS

Print theme phrases on paper footprints.

1. THINK AND GROW. Peter didn't think. He didn't count the cost. It took Peter a long time to grow in Jesus. He made lots of mistakes. Peter denied Jesus three times when Jesus was arrested. Peter heart was in the right place and Jesus loved him for his loyalty.

Peter had good intentions and then his faith faltered. Even then, Peter knew who to call, the only one who could help him...Jesus!

2. FAIL AND GROW. There were many times Peter failed when he tried to do something big for Jesus. Did that stop him? No. He just seemed to pick up where he left off and tried again. Each time he failed, he learned something important and tried again.

Peter didn't begin to sink until he looked around at the wind and waves. Taking our eyes off Jesus and focusing on hard circumstances will cause us to sink too. Don't forget, when we cry out to Jesus, he catches us by the hand and raises us about our problems.

3. TRUST AND GROW. We cannot grow in Jesus unless we trust Him to know what is best for us. Peter knew that and each event in his life brought him closer to the Savior he loved. A growing Christian is not perfect. A growing Christian is a trusting Christian.

When Jesus got in the boat, the storm stopped. When we have Jesus in "our boat" the storms of life will be calm and we can keep growing in Him. We might never walk on water but there will be times when we must remember that all Jesus asks of us is to look at Him and keep on growing!

CLOSE IN PRAYER

CRAFT

Choose a project from our list or design your own craft keepsake to remind students to GROW IN JESUS.

oooO
()
\ ()
\ _)



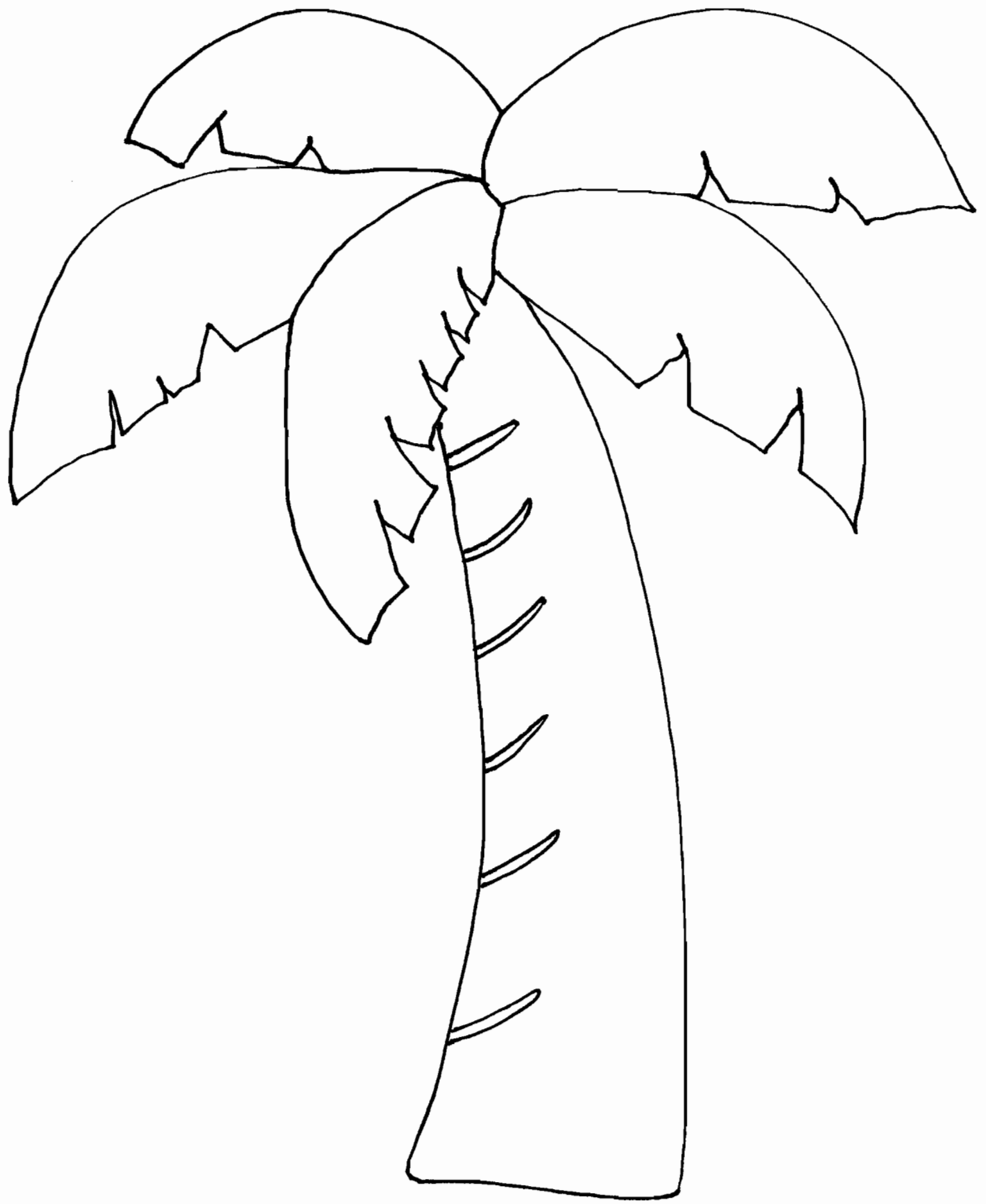

ISLAND PORT OF CALL #3:

BARNACLE BAY SHIPWRECK ...FOLLOW JESUS!

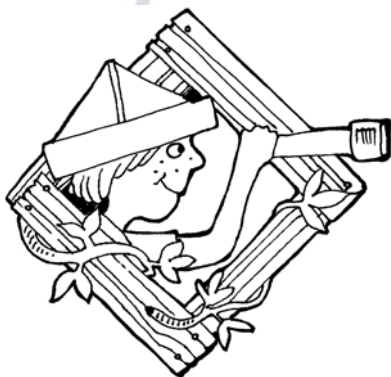

DECORATION: Create an atmosphere of destruction by darkening a room filled with old wooden planks, wooden boxes, barrels, life jackets, ropes, seaweed, broken pottery, jewelry falling out of a chest and other evidence of a shipwreck. Play a CD with sounds of a thunderstorm.

COSTUME AND CHARACTER: Wear a sailor hat, blue denim shirt, dark shorts and tennis shoes. Become a sailor lost at sea remaining with the ruins of the ship until help arrives.

BARNACLE BAY SHIPWRECK WELCOME: Have you brought help? I am desperate to be rescued from this forsaken island. I promise I will FOLLOW you anywhere! Help me escape. I have tried to protect the precious cargo aboard the SS Barnacle but I can no longer be the keeper of the ship.

A terrible storm destroyed my ship. The wind blew so violently that all the dishes fell to the floor. We tried our best to save the old ship but we could not. Out of 208 souls on board, only this ship mate (*your helper*) and I remain. I wanted to sail the world, find my fortune and go home a hero. I followed the wrong dream. I wouldn't listen when people said I made a mistake.



SHOW OLD BOTTLE AND ROLLED PAPER: I found this note in a bottle washed ashore. Let me read the message. Tell me what you think.

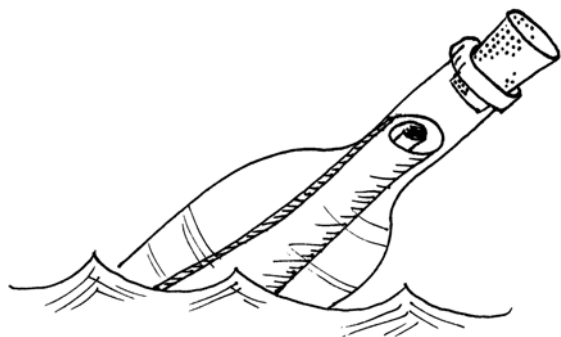

Near my island many shipwrecks occur. People built a hut and tried their best to save stranded sailors. Many lives were saved by this dedicated group of lifesavers.

Some rescued sailors were so grateful, they gave money to build a bigger station. More boats were used and the little station grew. Some station members were unhappy that the building was small so they bought a bigger building and filled it with beautiful furniture and comfortable beds. Now people enjoyed coming to the station for dinner. It became a club. Very few members answered the bell when a ship was wrecked off shore.

Pretty soon, they didn't want dirty, wet people in their beautiful club so they built a shower house outside. Why continue rescuing those crazy people anyway. Shouldn't they know to stay out of a storm? Some dedicated lifesavers decided to build a hut down the beach and did so. After a few years of lifesaving, the same thing happened and if you visit the seacoast today, you will find many exclusive clubs along the shore.

Shipwrecks are frequent, but most people drown!

Help me! There is no one to save me!



Did you read that? Most of the people drown! No one has been looking for me all these months. Others used to be lifesavers but they forgot their task. If I ever got out of this mess I will FOLLOW Jesus and not my own silly dreams.

BARNACLE BAY SHIPWRECK MEMORY VERSE

*Jesus said, "Follow Me and I will make you fishers of men."
Matthew 4:19*

Print each word on colorful paper fish. Attach to string/fishing line and hang the string of fish from a pole. Arrange the words in order and let students say the verse aloud.

BIBLE WATER STORY:

FISHING WATER

Matthew 4:18-22: Have you ever gone fishing? What is your favorite part? What do you hate the most? Lots of people enjoy fishing because of the excitement when they catch a fish and they enjoy eating them too!

Jesus saw two brothers, Simon (Peter) and Andrew, casting a net into the Sea of Galilee because they were fishermen. Jesus walked up to them and said, "Follow me and I will make you fish for people." Immediately they left their nets and followed him.

He walked a little farther and saw two more brothers, James and his brother John, in a boat with their father, mending their nets. Jesus called them! Immediately they left the boat and their father, and followed him.

All in all, Jesus called 12 men to follow him. They came from all walks of life but each man decided to follow this Man from Galilee. Their lives were about to change forever.

What did Jesus mean when He said, "Follow me and I will make you fish for people"? I don't know about you but I have never seen a person dangling from the end of a fishing pole! He was about to teach them how to fish for people.

Jesus asks people to come to Him, to follow Him. He said, "Come to me, all of you." Matthew 11:28 When we follow Jesus, we fish for people too. It is not enough to know we are going to heaven. Our job is to help as many people as possible follow Jesus. Each of us is a missionary wherever we live.



BARNACLE BAY SHIPWRECK LESSONS

It could be that you are thinking, I don't know how to follow Jesus. What does that mean?

1. ACCEPT JESUS AS SAVIOR
2. LEARN ABOUT JESUS—READ BIBLE AND STORIES
3. GO TO SUNDAY SCHOOL AND CHURCH
4. PRAY OFTEN—TALK TO HIM
5. DO WHAT PLEASURES GOD

Display three hand drawn tropical fish as you explain how to follow Jesus.



BIBLE TROPICANUS FISH: It's hard to read and understand God's Word when we are young. Don't worry! As you grow older, your reading skills will get better. Then it becomes easier to understand the Bible and to follow Jesus by reading the Bible. If it is hard to read it, watch Bible story video's and CDs. Read Christian kids' books. Listen to Bible stories on the radio. The Bible is God's message—like the message in a bottle.



PRAY FISHIA: God created a great way to talk to Him personally. It's better than a cell phone or a computer. Here's the plan. Whenever you want to talk to God, just think the words and He hears. If you want to talk to God every minute of every day, He is listening. He loves to hear us thank Him, praise Him and ask for help when we have big trouble! It is not possible to follow Jesus, unless prayer is part of our lives.



DO RIGHT SHARKUS: Once we learn all we can about following Jesus, it is time to put all that good information to practical every day use. Do what is right. Be kind, patient, loving. Think your way through problems instead of becoming impatient and angry.

CLOSE IN PRAYER

CRAFT

Choose a project from our list or design your own craft keepsake to remind students to FOLLOW JESUS.



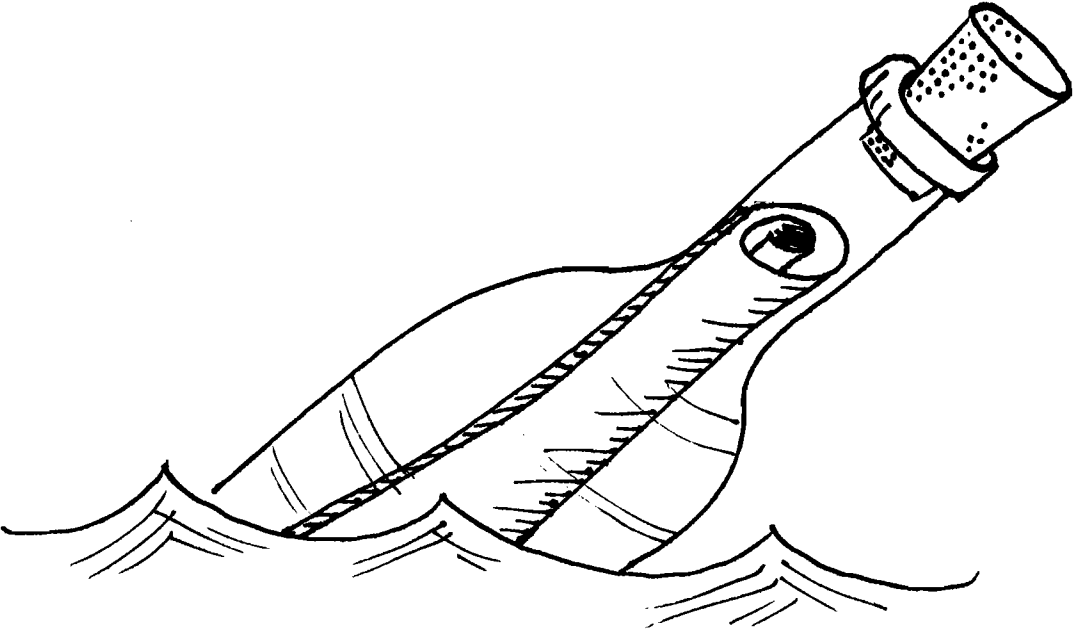

ISLAND PORT OF CALL #4

YOU CAN TOUCAN ISLAND ...LEARN ABOUT JESUS!



DECORATION: This Bible Workshop represents a tropical beach where all types of tropical birds are featured. If desired, leave the classroom atmosphere and set up an outdoor area where you can pitch a tent, make a lean-to hut, pile sand, fill a pool with water and fly balloons. Fill the space with bird sounds (CD sounds). Add bird figurines, real birds and stuffed birds as available. The toucan can be the central bird. Find a picture or stuffed toucan to place in the area.

COSTUME AND CHARACTER: Follow general curriculum guidelines for costume ideas. Your character is a friendly island native greeting everyone with "Aloha".

YOU CAN TOUCAN WELCOME: Aloha! Welcome to YOU CAN TOUCAN ISLAND where "you can, too can" learn about Jesus. This special island is a place where young disciples of Jesus figure out how to LEARN ABOUT JESUS. Enjoy your stay on my beautiful island.

Serve guests a colorful island drink in clear glasses with an orange slice stuck on top. Try mixing a good fruit juice with ginger ale and an ice cube!

YOU CAN TOUCAN MEMORY VERSE

Thy Word have I hid in my heart that I might not sin against Thee.
Psalm 119:11

Toss beach balls around the group for a few minutes. Then collect the balls and ask students to stand in a circle. Teach the verse by assigning one word to each student.



Toss the ball in the air and ask the student with the appropriate word to rush into the circle to catch the ball before it drops. Play the game in the correct word order. At the end of the game, toss the ball to individual students and ask them to say the entire verse.

Adjust the game to fit your group. Younger students may feel more comfortable tossing the ball around the circle while the group says the verse aloud together.

BIBLE WATER STORY

CALM WATERS

From Mark 4:35-41: Have you ever been outdoors during a summer storm? What do you see, feel and hear during a storm? *(Students respond: thunder, lightning, rain drops, wind, fear, joy, etc.)*

SPRAY BOTTLE: I want you to feel a storm coming! *(Pull a spray water bottle from a hidden spot and spray as many students as possible. Encourage laughing, wiggling and dodging spray.)*

You didn't know I was going to create a storm on YOU CAN TOUCAN ISLAND. Some of you ran away from the water. Some of you wanted to get as wet as possible. And others tried to get me to stop spraying water by screeching and hurting my ears. The point is that you all reacted to my "surprise storm".

The Sea of Galilee is famous for it's storms that are scary. Terrible storms come quickly even when the sky is clear. Fishermen and other boat riders are always looking for those sudden storm.

The Bible tells us a storm story. Jesus was riding in a boat with His friends seated in the spot saved for important guests. He sat in a little seat placed at the front where a carpet and cushion are arranged. One sailor stands on the deck to look out for rocks.

Jesus was not upset by the awful storm. He fell asleep after a long day of teaching and healing sick people. The men in the boat were very afraid. They were puzzled that Jesus could sleep.

The men became so afraid of the storm that they woke Jesus and asked if He cared that they were all about to die! Jesus woke up, looked around and said, "Hush, be still!" And, it was still! The storm stopped immediately. The wind disappeared. The waves calmed and the boat settled into a gentle rocking.



Jesus asked, "Why are you so afraid? Why don't you have any faith?" He thought the men should have known that no harm would come to them while they were with Him. So amazed were the men that they became afraid again. "Who is this man, that even the wind and waves obey Him?"

YOU CAN TOUCAN LESSONS

Print Theme Phrases on Hand Drawn Bird wings. Add feathers if desired.

Just like Jesus calmed the water, Jesus can calm our hearts. How? LEARN ABOUT JESUS. It is important to hide God's Word in our hearts and learn about this calm peace. The more we learn about Jesus, the more we experience God's wonderful peace.

PEACE IN THE STORM OF SADNESS: We do not like to think about people we love dying and leaving us. When sorrow and sadness come, Jesus tells us about the glory of wonderful life in Heaven.. He changes darkness into sunshine when He tells us about eternal life so we can smile when we think about the person we love living with Jesus.

A gardener working in the beautiful gardens of a wealthy master. He had a lovely bed of flowers which were his favorites. He tended them carefully and lovingly. One day he came to the garden to find the loveliest flower picked and gone. He was angry and sad. He met the master and shouted angry words against the person who had stolen his flower. The master calmed the gardener and said, "Hush, I picked that flower for myself."

Think of the gardener as you, the flowers as the loved one who died and the master as Jesus. Jesus loves us and our loved ones. He is the one who takes us to be with Him. We are sad here on earth but our loved ones are joyful as they reach heaven. In the storm of sadness, Jesus gives us assurance that we shall meet those we love and lost for a little while. Even in the storm of sorrow and sadness we find peace in Jesus to calm us.

PEACE IN THE STORM OF TROUBLE: Sometimes things happen and we just don't know what to do. We are in big trouble and there doesn't seem to be an answer. It's time to say to Jesus, "Lord, what would you have me do?" The real tragedy is not the trouble but not asking for help. Next time you are in trouble ask Jesus to help and follow His advice. When you do, you will be calm in the storm of trouble.



How do we know when we get information from God?

1. Wise people help us get out of trouble.
2. God's Word will give us good advice.
3. Pray.
4. Listen to the still, small voice inside you.

PEACE IN THE STORM OF WORRY: The opposite of peace is worry. What do we worry about?

1. We worry about ourselves.
2. We worry about the future.
3. We worry about those we love.

Jesus tells us about a Heavenly Father whose hand will never cause His child a needless tear and of a love beyond which we can never drift. In the storm of worry, Jesus calms us and bring the peace of the love of God.

The more I learn about Jesus, the more I want to learn. To be His young disciple, learn how to have peace in the midst of the storms of life. The story about Jesus calming the water in Galilee is more than just an adventure on a dark and stormy night. It is the story of God's power in our lives.

CLOSE IN PRAYER.

CRAFT

Choose a project from our craft list
or design your own keepsake
to remind students to LEARN ABOUT JESUS.



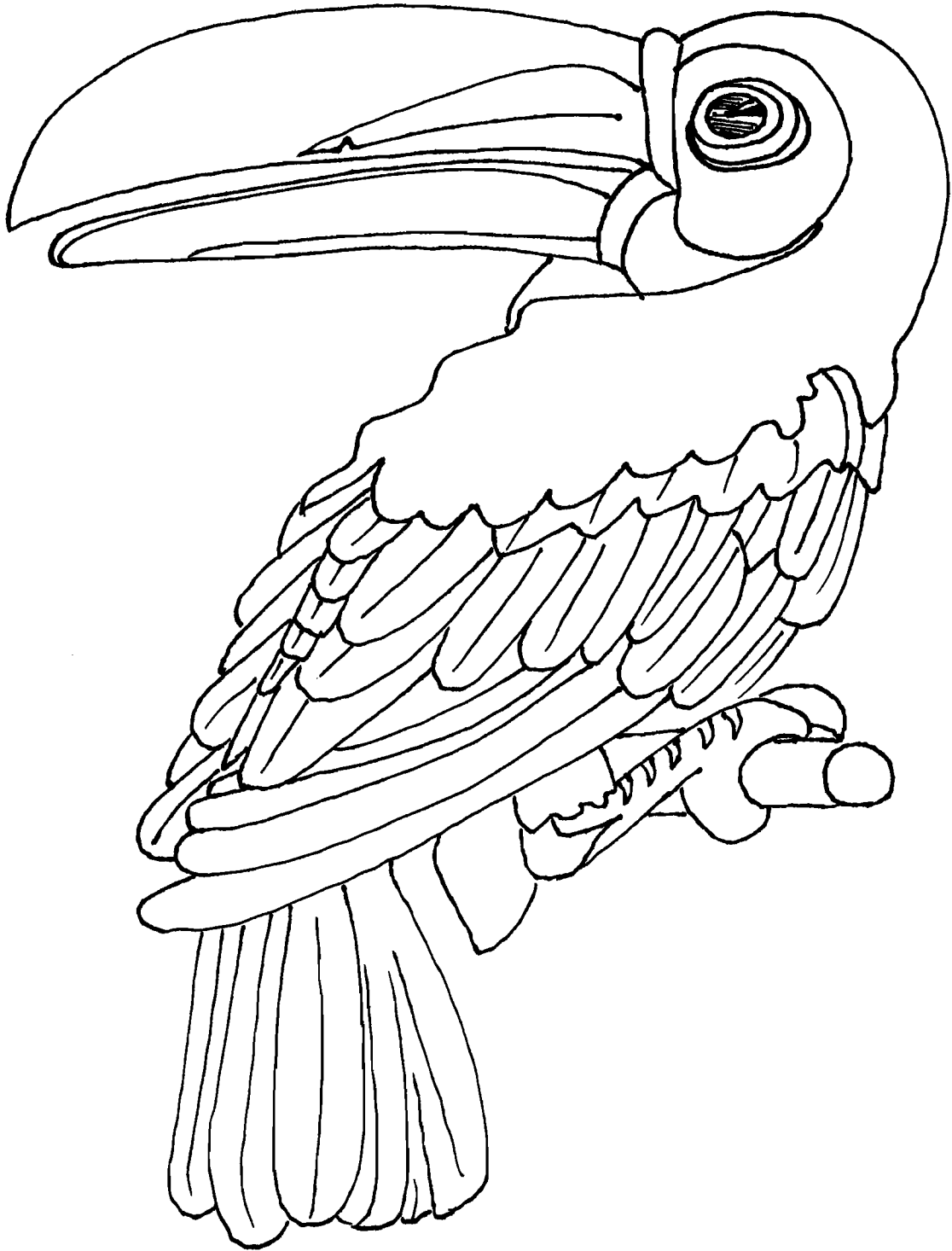

ISLAND PORT OF CALL #5:

THE LIGHTHOUSE

SHINE, JESUS, SHINE!

...TEACH OTHERS ABOUT JESUS!

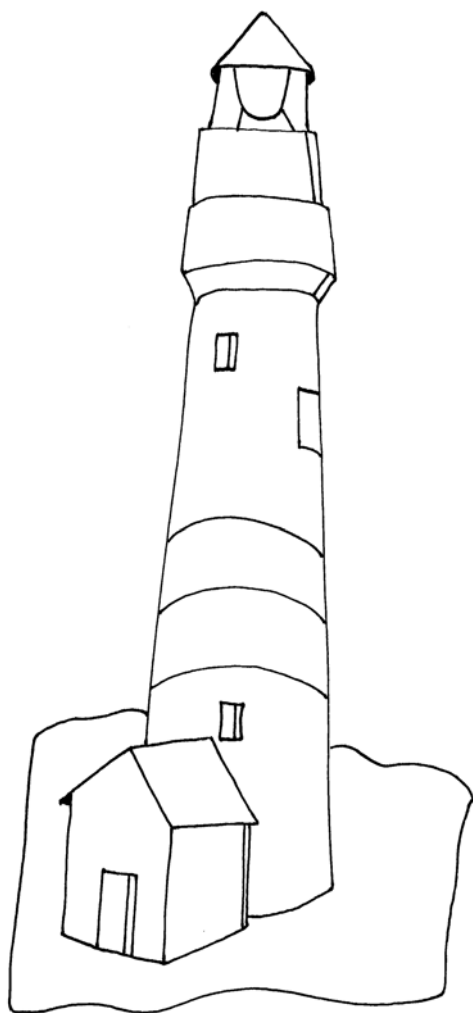

DECORATION: This Bible Workshop represents the inside of the top of a Lighthouse. Place plain benches around the edges of an empty room. Flood the room with brilliant light. In the center of the room place a spotlight. It can be a collection of work lights, lamps, white twinkle lights and electric lanterns. Combine all the light you collect to make the room overly lit. Scatter items around the room: binoculars, telescope, maps, charts, compass, telephone, radio, office equipment.

COSTUME AND CHARACTER: Wear a sailor's hat, blue denim shirt and dark shorts or slacks. You are the Lighthouse Keeper. It is an important job so you are earnestly serious about the "keeping of the light."

LIGHTHOUSE WELCOME: Step lively mateys. Find a seat along the edge of my Lighthouse. We have an important job today. I heard that a ship is lost in the rough seas somewhere in our area. We must find it and warn it to change course.

Talking into microphone: Shore to ship, shore to ship. This is Ocean Motion Lighthouse. Change course 20 degrees immediately. Rocks ahead! Change course or be wrecked on the reef!



This reminds me of one day when I was in the navy. I was serving on a battleship at sea in heavy weather. The captain kept an eye on the fog as night fell. Shortly after dark, the lookout reported, "Steady light on the starboard bow."

I braced myself for a collision with that ship. The captain called: "Signal that ship! We are on a collision course, advise you change course 20 degrees."

Back came a signal: "Advise YOU change course 20 degrees."

The captain sent another signal: "I am a captain. Change course 20 degrees."

"I am a seaman second class," returned the flashing light signal. "Change course 20 degrees."

By this time, my captain was furious. He shouted, "Send the signal -I am a battleship. Change course 20 degrees!"

Back came the flashing light, "I am a lighthouse. Change course 20 degrees!"

We changed course!

The lighthouse is the beacon of warning for all ships and air traffic in these waters. During your visit to my lighthouse, you will discover that each of you is a lighthouse when you are a young disciple of Jesus. Jesus calls us to TEACH OTHERS ABOUT JESUS!

LIGHTHOUSE MEMORY VERSE

And the things you have heard from me...
tell faithful men who will teach others.

II Timothy 2:2

Place individual words of the verse at random on walls and ceiling before class. When the activity begins, darken all lighthouse beacons and search for the words with a flashlight. Students find the appropriate words as they learn the verse. Non reading students will just enjoy the search.

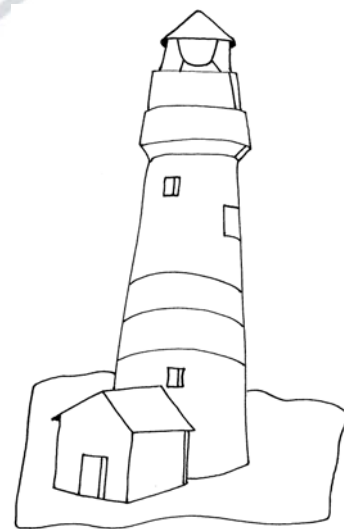

BIBLE WATER STORY

From Matthew 3:13-17: I am a lookout for my lighthouse. The Bible tells about another person who was a "lookout". His name was John and he was Jesus' cousin. John was an odd guy. He lived in the desert and wore animal skins for clothing. He ate honey and locusts (grasshoppers). People gossiped about odd John.

John was also a preacher. People asked if he would tell them in a simple way why he was preaching. John said, "I am a voice of one crying in the wilderness. Make straight the way of the Lord." He was telling them he was a lookout for the Messiah. The Jewish leaders were puzzled and kept asking questions because he was baptizing people with water.

People came to John and he poured water over their heads as a symbol of getting their lives right with God. He said "I baptize in water, but there is Someone among you that you do not know. It is He who comes after me. I'm not worthy to untie His sandal."

The next day Jesus walked along the Jordan River and John said to the crowd: "Behold, the Lamb of God who takes away the sin of the world! This is the One for whom I have been on the lookout. He is higher than I and He existed before me."

John baptized Jesus in the Jordan River. When he did this, the Spirit of God came from heaven like a dove and said so everyone could hear, "You are My beloved Son, in You I am well pleased."

RIVER WATER

LIGHTHOUSE LESSONS

Print theme verses on hand drawn lighthouses.

Use curriculum lighthouse as pattern. Display on the walls.

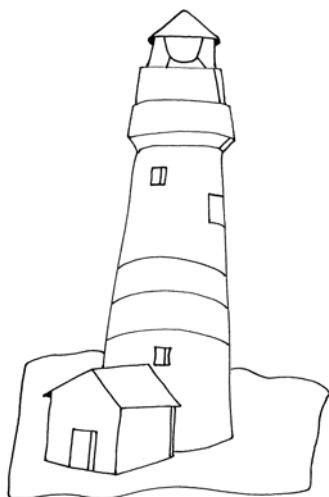

This lookout (John) told people that Messiah had come and Messiah was Jesus. Some believed John the lookout but many did not believe Jesus was the Son of God.

John did not stop talking about Jesus. He kept teaching others until he was arrested and put to death. John loved the people around him so much that he kept telling them the Savior was among them.



John's life teaches us that we must keep telling the good news about Jesus to everyone we meet. Some will believe you and others will not believe. It is not your job to force them to believe. God does that. Just tell Jesus' story and let God do the rest.

SHINING LIGHT: Believers should be a shining light to people who need to know Jesus.

Let your light shine before men in such a way that they may see your good works and glorify your Father who is in heaven. –Jesus Matthew 5:16

TEACHING LIGHT: Whatever you learn about Jesus, no matter how simple, tell somebody else. Become a teacher!

And the things which you have heard from me in the presence of many witnesses, these entrust to faithful men, who will be able to teach others also. –Paul II Timothy 2:2

PROUD LIGHT: Christians have a wonderful message to tell others. Be happy to tell it to everyone.

Do not be ashamed of the gospel of Christ...." –Paul II Timothy 1:8

TRAVELING LIGHT: Jesus' message to all His followers is to "Go". We must carry the good news of Jesus with us all around the world.

Go therefore and make disciples of all the nations, baptizing them in the name of the Father and the Son and the Holy Spirit, teaching them to observe all that I commanded you...." –Jesus Matthew 28:19-20

CLOSE IN PRAYER.

CRAFT

Choose a project from our craft list
or design your own keepsake
to remind students to TEACH OTHERS ABOUT JESUS.



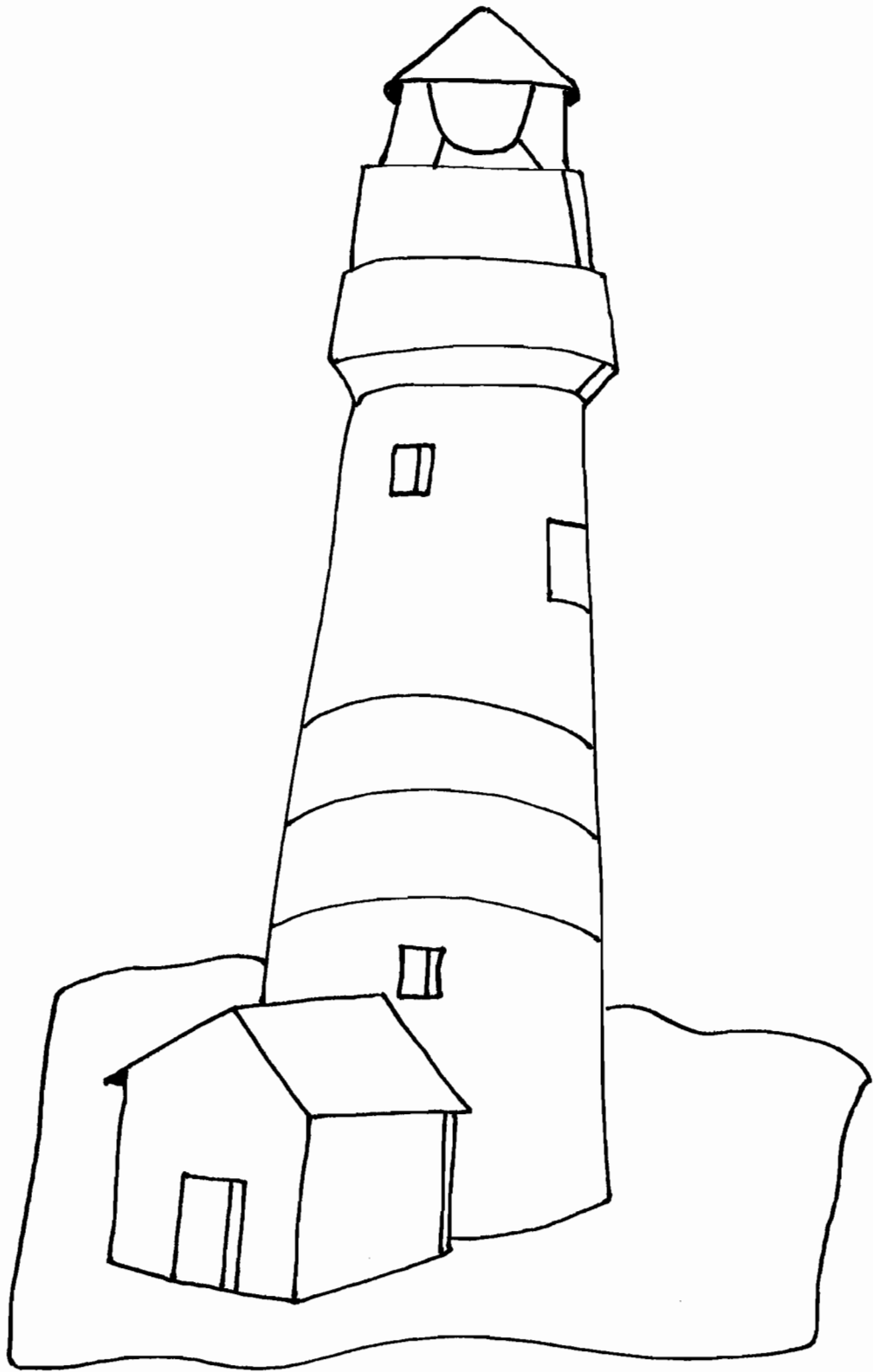

OCEAN MOTION PRESCHOOL

THE GUPPIES

Age 4-Preschool Age 5

Decide if your preschool students are mature enough to become one of the five major rotation groups. If so, let them join in all activities. If not, separate them and follow our Home Base schedule.

THEME: GUPPIES study the same spiritual themes as older students. Each day's activities emphasize what older students are learning but with a separate preschool teaching team.

Use the curriculum schedule as a guide providing plenty of time for rest, play and crafting. At no time feel pressure to attend activities if students are tired or upset. Cancel your group's appearance in favor of free play if the group needs a break.

TEACHERS: There should be one helper for every 2-3 GUPPIES. Parental help is welcomed and encouraged. Wear comfortable clothing and shoes. Make each day fun and relaxing. Students should be able to chatter without being reprimanded. Run away children or rudeness must not be tolerated.

HOME BASE DECORATION: Home Base is a place where preschool activity takes place. Make simple tropical decorations based on curriculum instructions.

CRIERS: If a few children cry continually, keep them busy separately at Home Base. Movement around the building may threaten some young children. If they never calm down, ask a parent to stay with their child or take that child home to try again next year. Accommodate as many young students as possible but crying and temper tantrums discourage teachers, helpers and students. The child may be too young and will do better at a later time.



PLANNING A PRESCHOOL DAY

Two hours is a long time for preschool children. Plan their Vacation Bible School day around lots of play time. Bring beach balls, balloons, bubbles and other toys to play indoors or outdoors. Purchase story book from the local Christian book store. Use these books as fill in teaching times when needed.

Travel with students to all areas of OCEAN MOTION as suggested in the daily schedule. If your students tire easily, omit some activities. They do not have to participate in every activity center. Most preschool groups handle these events well.

It may be possible to include preschool children as one of the five major groups, allowing them to participate in every Bible lesson and activity. Decide before the week begins and staff the area accordingly. Adapting the Bible Workshops is the biggest adjustment. Provide Home Base as an emergency option in case some children need a break.



ON THE BEACH OPENING: *GUPPIES participate in the Opening. This is an opportunity to organize name tags/hats and gather the group before the day begins. If there are criers, ask a helper to take them to Home Base for a few simple activities. This avoids distraction for older students.*

SEA CHANTIES: *Encourage GUPPIES to participate in music time. Take students to the music area and stay with them fifteen minutes each day.*

SCUBA REEF: *Take GUPPIES each day and remain with them to help with the undersea activities.*

MAUI CHOWIE BEACH HUT SNACKS: *Take students to snack time. Sit with them. Use this time as a bathroom and hand washing break.*

WHALE OF A TALE STORY TIME: *Our suggested continuing story is a Chip and Clare Conley adventure called TREASURE ON ESPERANZA ISLAND. It is NOT written for their age group but many preschool children enjoy it!*



ISLAND PORTS OF CALL BIBLE WORKSHOPS: Rather than duplicating decoration, take your students to one workshop each day for Bible time. Tell the teacher you will use their room for fifteen minutes when their class is not in session. Use props in each area to tell the Bible story. Adapt lesson plans designed for older students to fit little ones. Activities may be used or eliminated at the discretion of your staff.

SAND CASTLE RECREATION: There are many games preschool students can play. If you feel more comfortable, plan separate recreation for them and create your own fun. However, this is rarely needed. Allow your little ones to enjoy the game leaders like the "big kids".

REST TIME: Allow time for unstructured play and rest. Darken Home Base, play a CD while encouraging quiet activity. Students rest on large floor pillows while a story is told or songs are sung.

CRAFTS: The perfect preschool craft is one completed with a minimum of teacher help. Provide coloring pictures and crayons for slow times. Modeling clay or Play Doh may be available. Stringing large beads is a favorite activity.

Purchase one craft project for each day. Keep the process simple and everyone will enjoy the experience the experience. S&S arts and craft catalog and web site offers many projects at www.swww.com or check out Guildcraft at www.guildcraftinc.com

Homemade projects are always appropriate. If desired, ask "crafty" people to design projects for your little ones and have fun!!!



OCEAN MOTION NURSERY

ITTY BITTY FISHIES

OCEAN MOTION VBS is not designed for students under four years old who do not respond well to high activity so loved by older students. A separate nursery offers security.

WHO SHOULD BE AN ITTY BITTY FISHY? Infants and toddlers (Birth-Age 3) who are children of teachers and helpers. It is the decision of your church to open ITTY BITTY FISHIES to the public.



HOW MANY HELPERS ARE NEEDED? Provide one helper per baby, in charge of all care for that infant from bottle to changing diapers. If that is not possible, ask one adult and a variety of assistants to watch the children. This staff may change daily.

SHOULD WE PLAN ACTIVITIES? This is a babysitting service but tell a few stories, sing songs, play CD's and DVD's, give wagon rides and take walks. Decide how much to do by the children's ages.

WHAT ABOUT FOOD? Ask parents. They may want to provide snacks. If you feed toddlers, work with kitchen staff to offer safe, healthful foods.

AVOID: Popcorn, hot dogs, lollipops or hard candy which become lodged in tiny throats. Check with the kitchen staff to see if their snack is appropriate for little ones.

HOW SHOULD WE DRESS? Wear cool, washable clothing and comfortable shoes. Costumes are not necessary. Just be comfortable and happy.

WHAT SHOULD WE BRING? Play Christian music. Bring a fan if days are hot and humid. Place the fan away from children, preferable on a shelf or high table.

