

# BASIC SOCKET

DIY Assembly  
Instructions

COLOR CORD COMPANY<sup>®</sup>

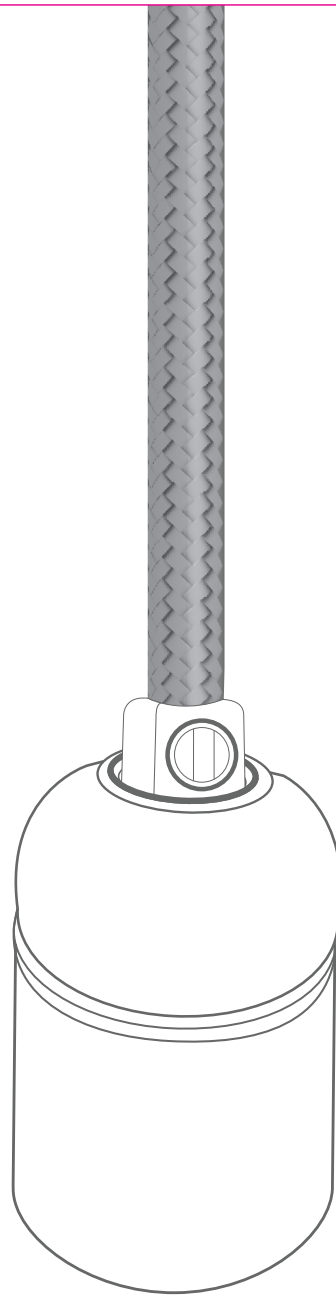

**Check disclaimer on the last page prior to beginning assembly.**

# WIRE A SOCKET

## Parts:

### TOOLS:



Blade



Screwdriver



Electrical Tape

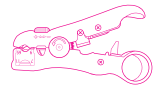

Color Cord 3000 stripping tool  
**NOT REQUIRED**

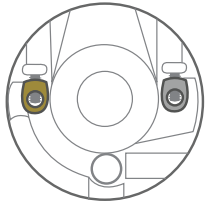

Terminal Plate

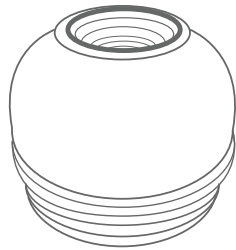

Cap

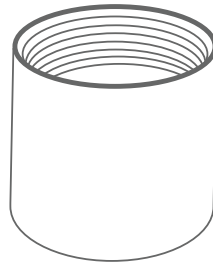

Shell

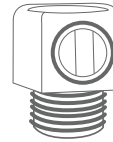

Cord Grip

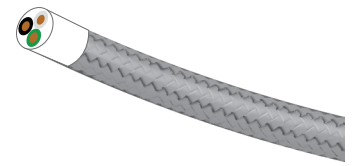

Cloth Covered  
Electrical Wire  
Your Choice of length.

## WARNING:

THESE SOCKETS ARE SELF LOCKING! Do not assemble the sockets with the terminal plate inside before it is wired. The terminal is designed to lock the socket permanently.

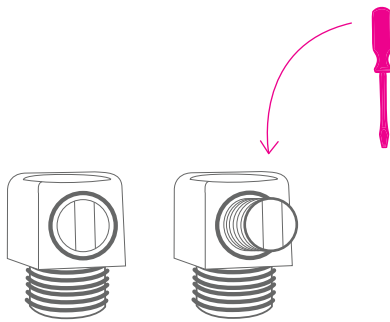

1. Grab the cord grip and loosen up the plastic screw (almost all the way out) to completely open up the inside of the cord grip.

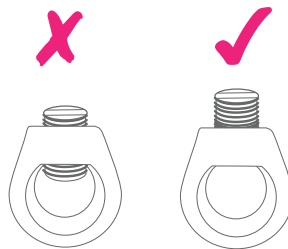

2. Look at the inside of the cord grip and make sure that the plastic screw is not covering any part of the opening.

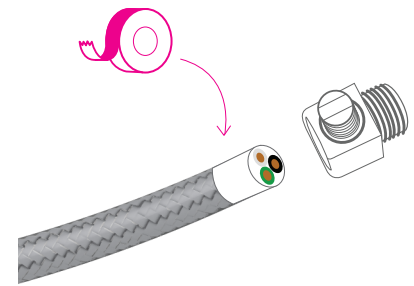

3. Insert one end of the wire into the cord grip's top opening. Cord grip's threaded end should face the end of the cord once inserted. You might need electrical tape around the end of the wire.

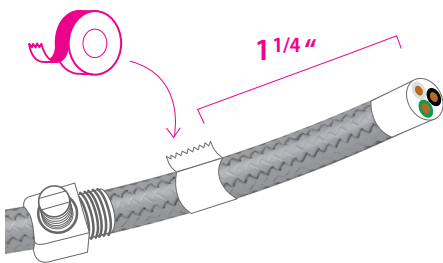

4. Measure 1 1/4" from the tip of the cloth covered wire, and wrap an inch of electric tape over the wire.

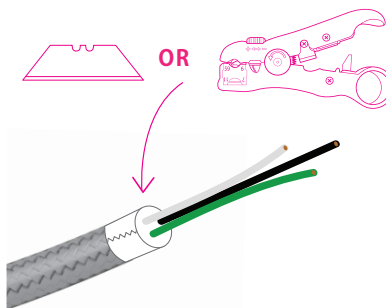

5. Over the mid section of the tape, strip the PVC housing to expose the 3 conductor wires. We recommend the use of our **Color Cord 3000 stripping tool**.

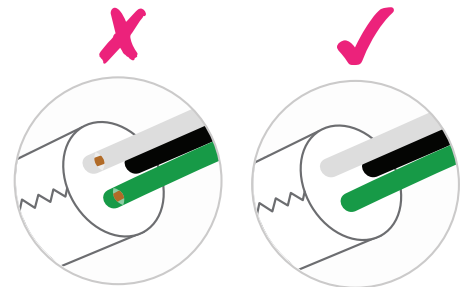

6. Make sure that there are no cuts on the conductor wires exposing the internal stranded copper wire.

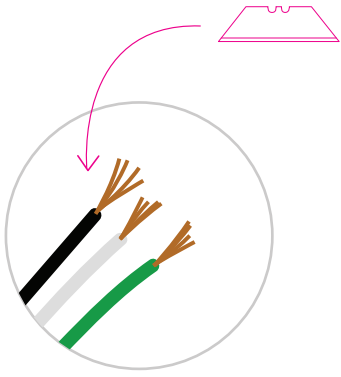

**7.** Strip one end of each wire to expose about 3/16" of the stranded copper wire.

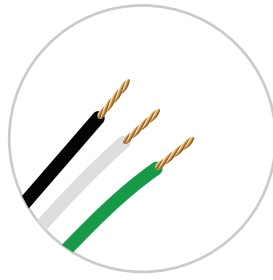

**8.** Using your fingers, twist the stranded wires together.

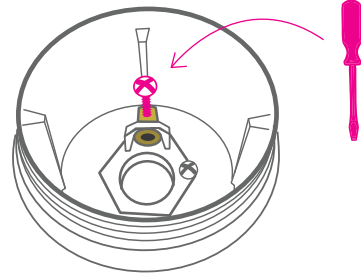

**9.** Flip the cap upside down & locate the screw of the ground terminal. Loosen the screw to about 1/8."

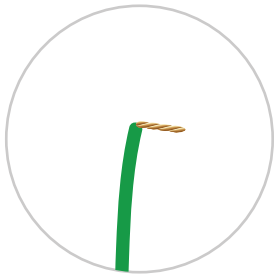

**10.** Bend the exposed end of the ground (green) wire to a 90 degree angle.

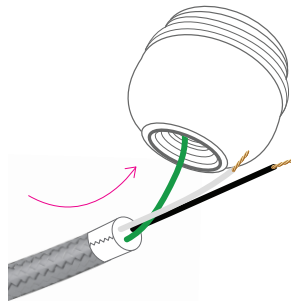

**11.** Insert ground (green) wire through the top opening of the cap.

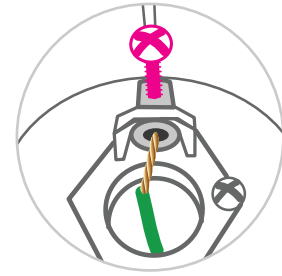

**12.** Insert the exposed section of the green (ground) wire into the ground terminal opening under the screw.

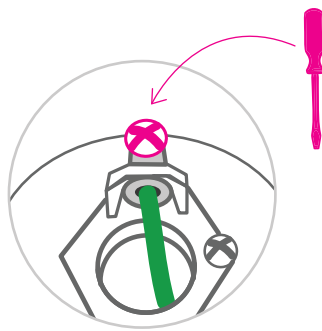

**13.** Make sure the exposed copper wire is completely inside the hole. Then secure wire in place with the screw.

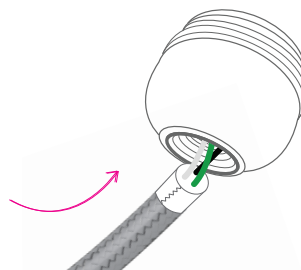

**14.** Insert the black & white wire through the top opening of the cap and push the wire inside the cap.

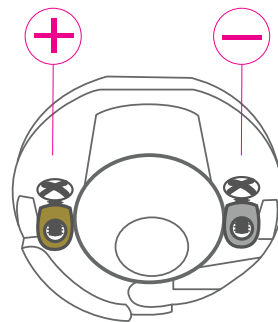

**15.** Locate the positive & negative terminal screws on the terminal plate. With the head of screws facing up, the positive terminal will be at the left (brass), and the negative to the right (silver).

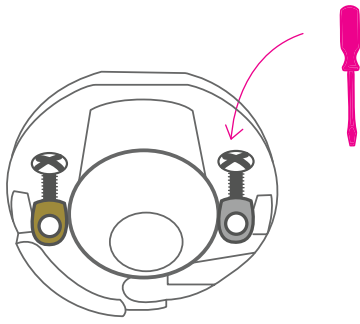

**16.** Loosen up both screws to open up the terminals.

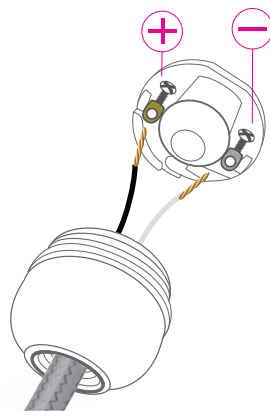

**17.** Align the terminal plate with the cap, so the black wire is aligned with the positive terminal, and the white wire with the negative.

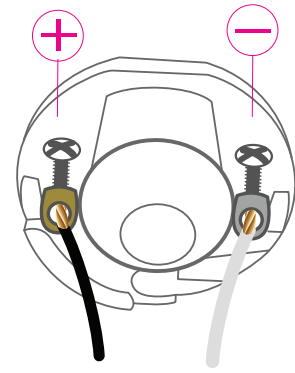

**18.** Insert the exposed copper of the black wire into the positive terminal screw, and the exposed white wire into the negative terminal screw.

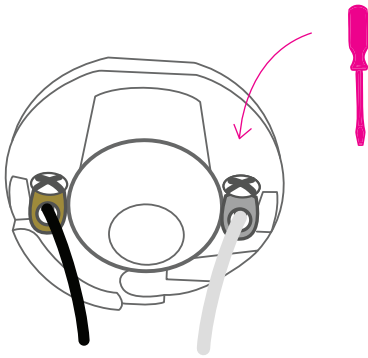

**19.** Make sure the exposed wire is all the way in, and tighten up the screws to hold wire in place.

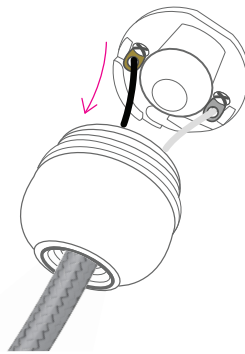

**20.** Pull the insert inside the cap. It should seat into the fitted ridges inside the cap.

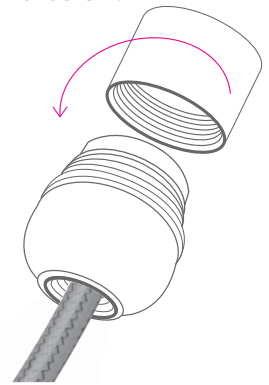

**21.** Align the shell with long internal threads facing the cap and twist it into the socket.

**22.** Twist the cap until it locks into the socket! You will hear a clicking/ratcheting noise as the cap is securely locking onto the socket. Once socket is locked, slide the cord grip towards the socket.

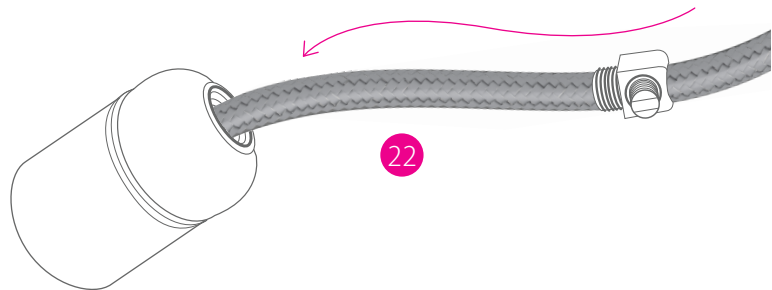

**23.** Twist the cord grip rightly into the socket!

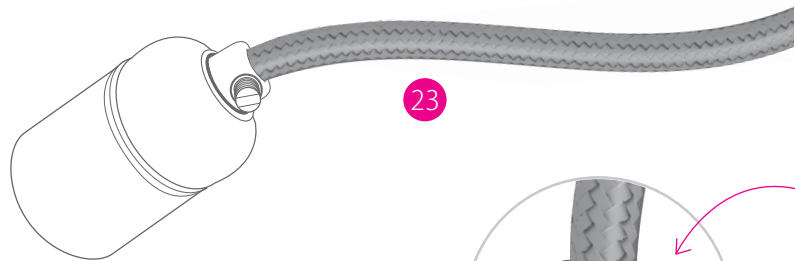

**24.** Screw the plastic screw back into the cord grip!

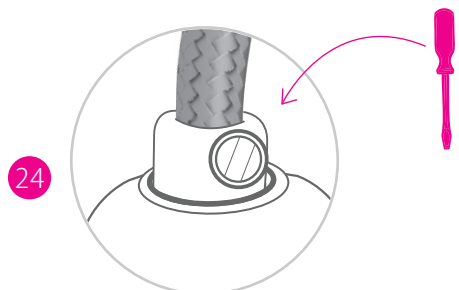

**ENJOY!**

# Educational, Tutorial and DIY Content Disclaimer

COLOR CORD COMPANY<sup>®</sup>

## Educational, Tutorial and DIY Kit Content Disclaimer

All material covered on **www.colorcord.com** and associated social media and print assets is for informational purposes only. We take no responsibility for what you do with this knowledge. We can not be held responsible for any property or medical damages caused by items you read about on our website. We would advise you to check your local laws and consult professional electricians/contractors for any project involving electricity, construction or assembly.

The DIY and tutorial material taught throughout Color Cord Company's website and other assets is for informational purposes only. By taking any information or education material from Color Cord Company, you assume all risks for the material covered. You agree to indemnify, hold harmless, and defend The World Effect, LLC & Color Cord Company from any and all claims and damages as a result of any and all of the information covered.

By taking and/or using any informational resources from Color Cord Company, you agree that you will use this information in a safe and legal manner, consistent with all applicable laws, safety rules, and good common sense. You further agree that you will take such steps as may be reasonably necessary or required by applicable law to keep any information out of the hands of minors and untrained and/ or immature individuals.

You must accept that You and You Alone are Responsible for your safety and safety of others in any endeavor in which you engage. While the material on [www.colorcord.com](http://www.colorcord.com) is provided in hopes that you build your own lighting, You are Responsible for verifying its accuracy and applicability to your project. You are Responsible for knowing your limitations of knowledge and experience. If you do any work with "main power" such as 120 or 240 VAC power wiring, you should consult a Licensed Electrician.

Some illustrative photos do not depict safety precautions or equipment, in order to show the project steps more clearly. These projects are not intended for use by children. Use of these instructions, kits, projects and suggestions is at your own risk. Color Cord Company and The World Effect, LLC disclaim all responsibility for any resulting damage, injury, or expense. It is your responsibility to make sure that your activities comply with applicable laws.

**The World Effect, LLC | DBA: Color Cord Company**

**PO BOX 12496**

**Denver, CO 80212**

**1.800.409.1070**