

iTRACKS

UNDERSTANDING iTRACKS

The i-Pilot system can be used to record sets of points that make up an iTrack. When recording an iTrack, i-Pilot starts to record GPS position data in the form of Track Points. The very first Track Point recorded is called the Start, and the last point recorded is called the End. i-Pilot sees a recorded series of Track Points as an iTrack. iTracks can be recorded and navigated. When the GOTO Button is pressed, an iTrack can be navigated To Start or To End. i-Pilot will navigate to the nearest Track Point and then navigate to the Track Point requested. Once the nearest Track Point is reached, it will then follow the Track Points in sequence back to either the Start or End based on the selection made. Once the Start or End is reached, i-Pilot automatically transition onto the set Arrival Mode. During iTrack navigation, i-Pilot takes control over all steering functions; speed can be manually controlled or the Cruise Control function can also be used. The motor speed must be set high enough in order to stay on the track given wind, current and other external forces.

WARNING

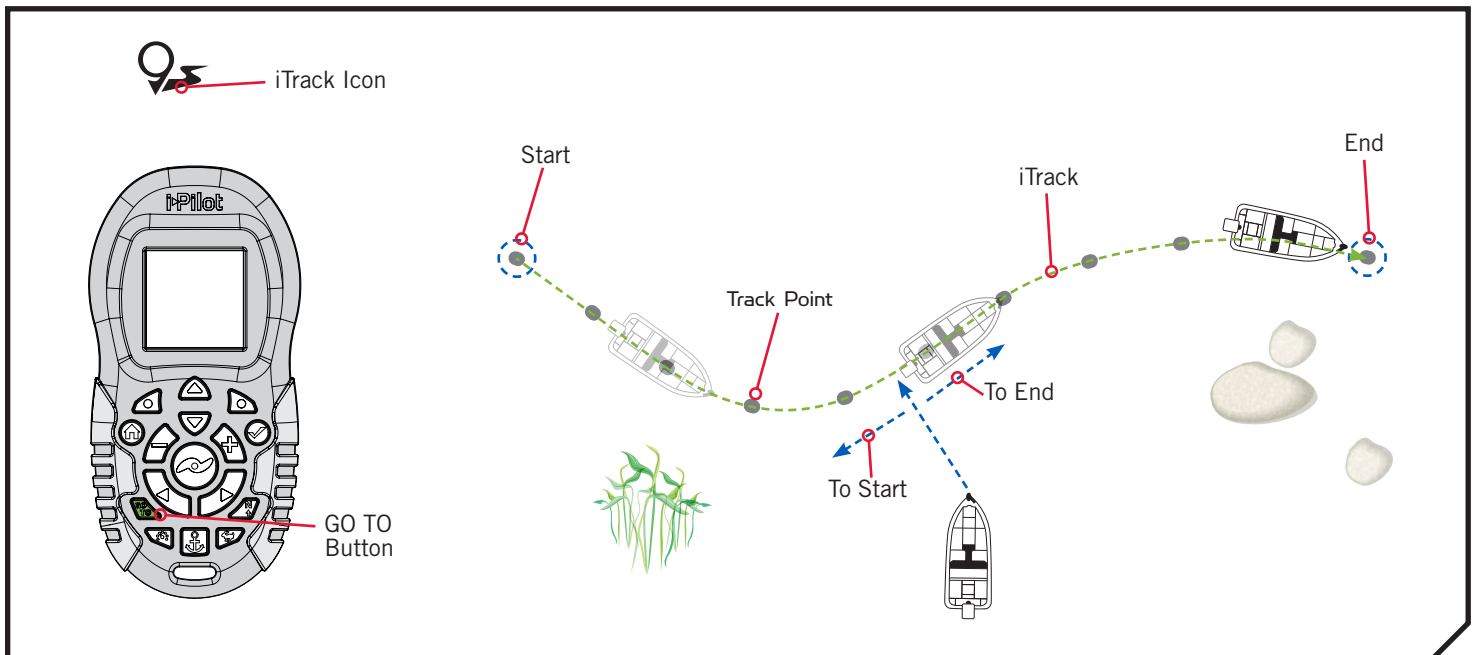

Watch for a turning propeller when working with iTracks. Auto Prop On is set to "off" by default. If Auto Prop On is turned "on", the propeller will automatically turn on when an iTrack is engaged, even if the engagement is accidental. A turning propeller can cause injury. If Auto Prop On is turned "off" the prop must be enabled before the boat will begin navigating an iTrack.



WORKING WITH ITRACKS >

> Recording an iTrack



1

- a. Use the Menu Up  or Menu Down  buttons until the menu at the bottom of the display screen shows the Record menu.
- b. Use the Left Softkey  to select the Record menu.

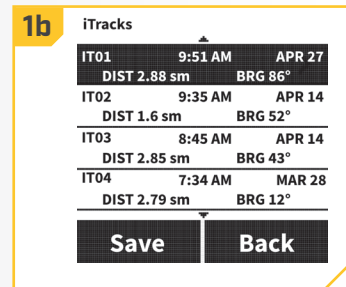
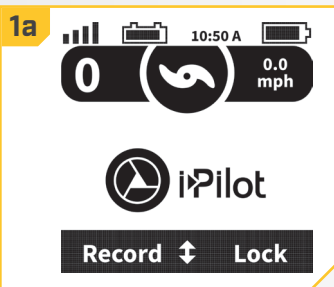
NOTICE: 16 iTrack memory locations may be recorded.





2

- c. The Record menu brings up a listing of iTracks. Use the Menu Up  and Menu Down  buttons to scroll to one of the iTrack locations.
- d. Press the Ok  button to select an iTrack location. Once a location is selected, the current location of the boat becomes the To Start location of the iTrack being recorded. The Control Head will emit a beep when an iTrack location is selected.

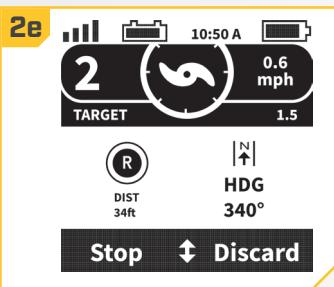
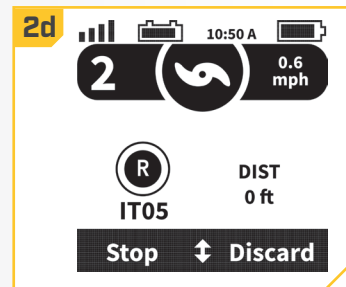
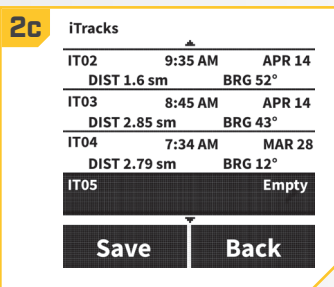



NOTICE: When recording an iTrack location, if an iTrack is already saved to an iTrack memory location, it will automatically write over previously saved data for that memory location. Once a new iTrack is saved into memory, the previous iTrack cannot be recalled. Discarding a recording will keep the previous iTrack in the memory location. Stopping a recording will save the new iTrack location into memory.



- e. Navigate the boat along the desired path or course.
- f. To stop recording an iTrack, use the Menu Up  or Menu Down  buttons until the menu at the bottom of the display screen shows the Stop option.

NOTICE: AutoPilot and/or Cruise Control can be used while recording an iTrack.

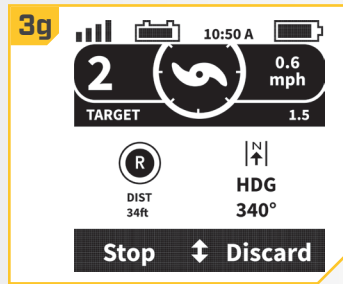

3

- g. Use the Left Softkey  to select Stop.
- h. The recording will end automatically if the two-mile distance limit is reached for the iTrack or if the Spot-Lock  or GO TO  button is pressed. It will also stop if the Right Softkey  is used to select Discard.



› Navigating an iTrack

1

- a. Manually navigate the boat to within a quarter mile of any point on the saved iTrack.
- b. Press the GO TO  button on the remote. The remote default is to first bring up saved Spot-Locks. Press the Right Softkey  to bring up saved iTracks.







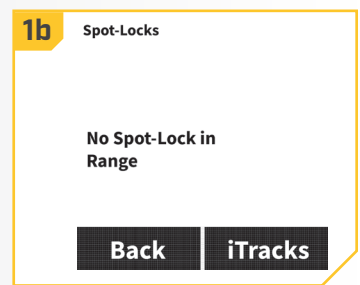
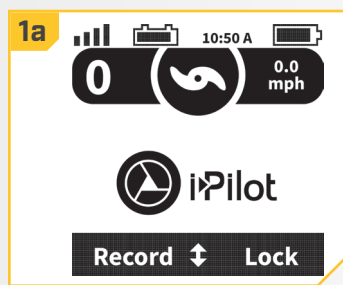

WARNING

Due to safety reasons, i-Pilot will not re-engage a saved iTrack greater than a quarter mile away.



NOTICE: If there are no Spot-Locks or iTracks in range, the remote will state there are none in range.

2

- c. Use the Menu Up  or Menu Down  buttons to select an iTrack to navigate.
- d. Using the Left Softkey  or Right Softkey  select the menu option to either go To Start or To End. The boat will navigate to the closest point recorded in memory on the iTrack and then navigate To Start or To End depending on the selection made until it reaches that point.
- e. The direction that the iTrack is being navigated can be reversed while the iTrack navigation is taking place. Use the Menu Up  or Menu Down  buttons until the menu at the bottom of the display screen shows the Reverse option. Use the Left Softkey  to select Reverse.

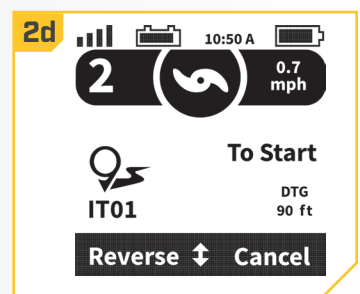
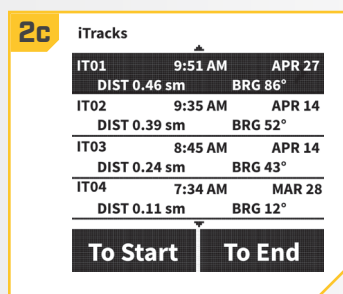

NOTICE: If Auto Prop On is turned "off" the prop must be enabled before the boat will begin navigating an iTrack.

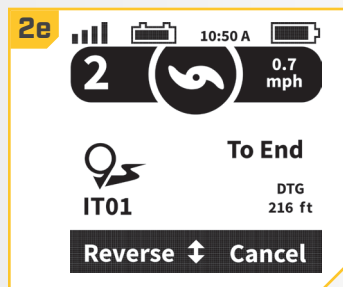

ITRACK ARRIVAL MODES

iTrack has four Arrival Modes:

1. Off - Once the boat has completed navigating the iTrack, the Prop will turn off. Off is the default Arrival Mode.
2. Spot-Lock - After the boat has completed navigating the iTrack, the system will go into Spot-Lock at the point where the iTrack is completed.
3. AutoPilot - Once the boat has completed navigating the iTrack, it will continue navigating in AutoPilot in the final direction the boat was traveling to navigate the iTrack.
4. Auto Deploy Talon - Available as an option only when the i-Pilot System is paired with a Talon. After the boat has completed navigating the iTrack, the system will deploy the Talon. If i-Pilot is paired with two Talons paired together, the action to Auto Deploy Talon will control both Talons.

Change iTrack Arrival Mode

1

- a. Press the Home button.
- b. Use the Menu Up and Menu Down buttons to find the Options menu.
- c. Press the Left Softkey to select the Options menu.
- d. Use the Menu Up and Menu Down buttons to find the Arrival Mode menu. Press the Ok button to select Arrival Mode.

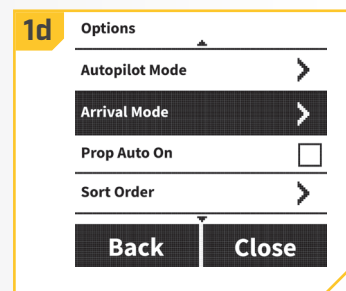
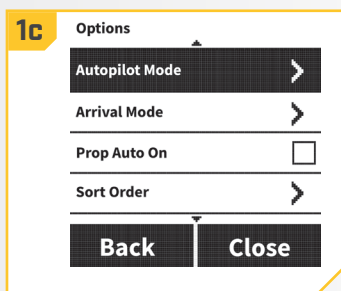
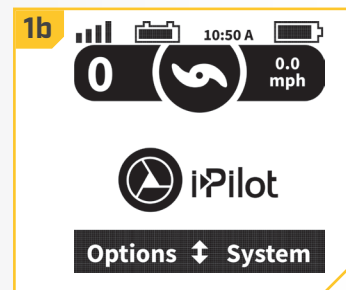
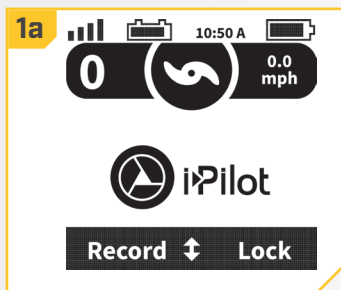

2

- e. Use the Menu Up and Menu Down buttons to find the desired Arrival Mode.
- f. Use the Ok button to select it. The circle to the right of the selected Arrival Mode will become solid when selected.
- g. Use the Right Softkey to Close the Arrival Mode Menu or Press the Home button return to the home screen.

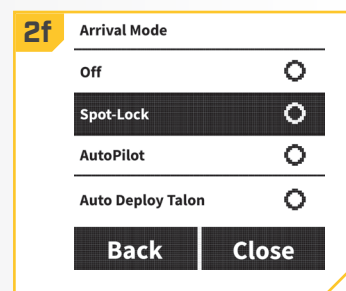
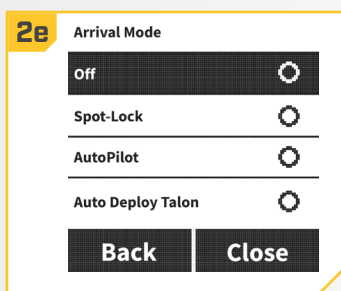

HEADING SENSOR

HEADING SENSOR FEATURES

Become familiar with the features of the Heading Sensor to maximize the capabilities it offers.

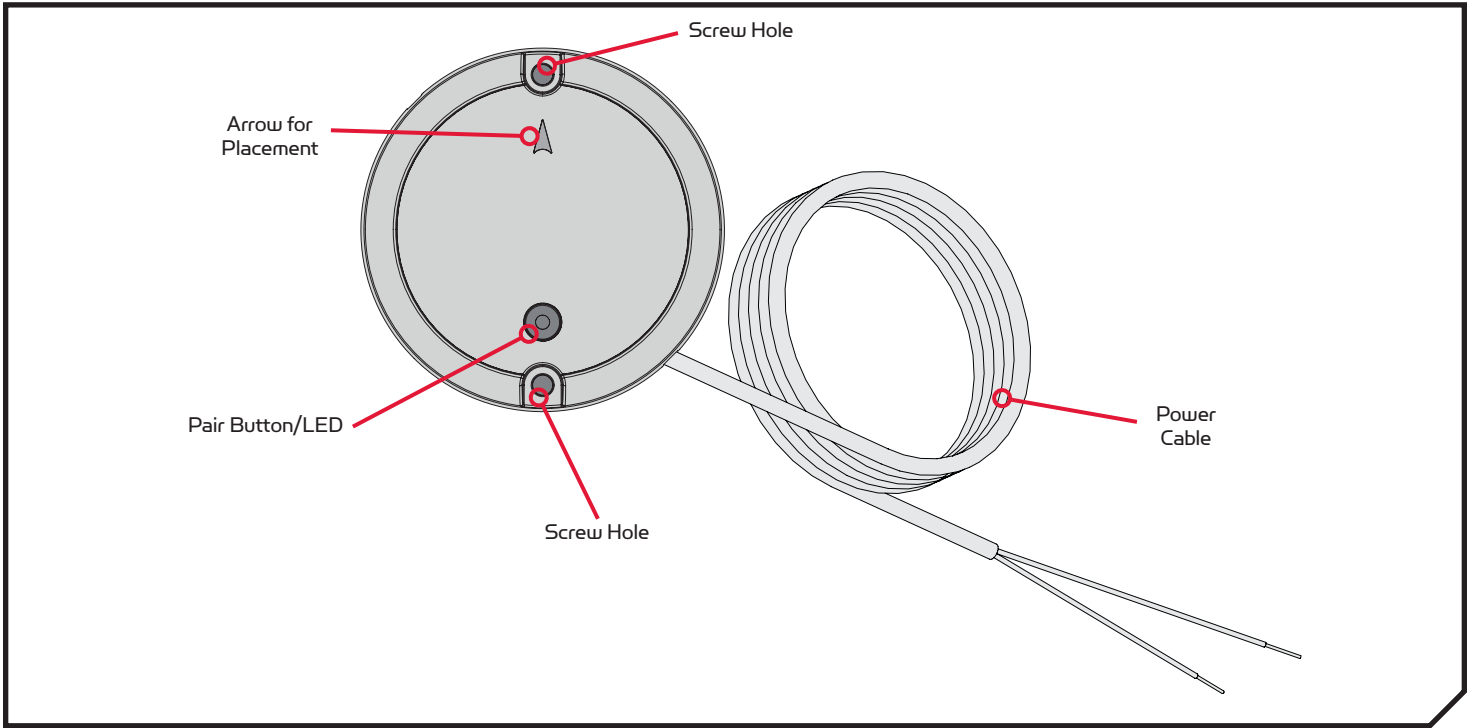

Heading Sensor Functions

The Minn Kota Heading Sensor provides boat heading information to a Bluetooth compatible i-Pilot equipped Minn Kota motor. It contains a compass that senses the boat's heading. The heading is used by the i-Pilot system for navigation features such as Spot-Lock Jog. The Heading Sensor does not contain a GPS receiver and it does not change or control the orientation of the boat. The Minn Kota Heading Sensor can only communicate with other Bluetooth compatible Minn Kota products.

NOTICE: The Heading Sensor does not come standard with all models. It can be purchased as an accessory. To learn more about Minn Kota accessories, please visit www.minnkotamotors.com.

WARNING

The Heading Sensor should not be used as a navigational aid to prevent collision, grounding, boat damage, or personal injury. When the boat is moving, water depth may change too quickly to allow time for you to react. Always operate the boat at very slow speeds if you suspect shallow water or submerged objects.

Do not install the Heading Sensor near ferrous metals or near anything that may create a magnetic field or interference. The Heading Sensor must be installed at least 24" from magnetic or ferrous materials on the boat including the base of the motor. Installation near the motor lead wires must also be avoided due to magnetic fields being created during high current draw situations.

Light Patterns

The Heading Sensor displays modes of operation with an LED located on the Pair Button. There are three distinct patterns that the LED will display to communicate different modes of operation. Become familiar with the modes of operation to be sure that the Heading Sensor is powered up and communicating with i-Pilot.

The three LED patterns displayed by the Heading Sensor are:

- 1. Power On - When the Heading Sensor is first connected to a power source, the LED will turn on for 3 seconds and then turn off.
- 2. Pairing - The Heading Sensor can be paired with i-Pilot. While the Heading Sensor is attempting to pair, the LED will flash on and off twice per second for up to 20 seconds. If the Heading Sensor is successfully paired, normal operation will begin. If the Heading Sensor is not paired, the LED will turn off.
- 3. Normal Operation - During normal operation when the Heading Sensor is connected to a power source and paired to and actively communicating with i-Pilot, the LED on the Heading Sensor will flash on and off once every 3 seconds.

INSTALLATION PARTS LIST

Item / Assembly	Part #	Description	Qty.
A	2996400	HEADING SENSOR ASSEMBLY	1
1	2393400	SCREW-#8-18X1-1/2 PPH TY AB SS *STAINLESS STEEL*	2
2	*	HEADING SENSOR	1

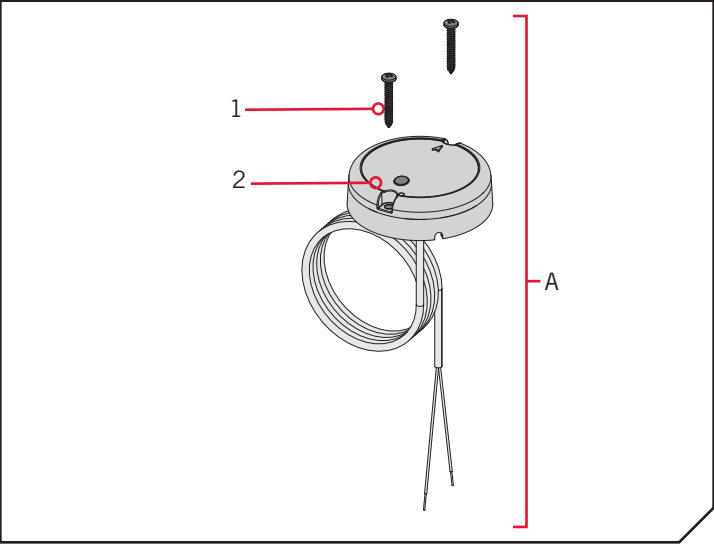

* This part is included in an assembly and cannot be ordered individually.

MOUNTING CONSIDERATIONS

Before mounting your Heading Sensor, give consideration to the following:

- 1. The Heading Sensor contains a compass that detects a magnetic field. Do not install the Heading Sensor near ferrous metals or wires that handle large currents, such as batteries or power cables.
- 2. Mount the Heading Sensor in an area that has a clear line of communication with the head of the motor that is installed with a Bluetooth compatible i-Pilot system for optimum performance.
- 3. Make sure the area under the mounting location is level and is clear to drill holes and installation hardware will not damage existing components below the mounting surface.
- 4. Test that the Power Cable that powers the Heading Sensor is long enough to reach the power source from the intended mounting location. If the cable does not reach the battery or intended power source, select a location closer to the source.
- 5. Mount the Heading Sensor horizontally. It should not be mounted upside down.

⚠ CAUTION

The Heading Sensor can be adversely affected by magnets or large, ferrous metal objects. Do not install the Heading Sensor within 24" of these objects as they will cause interference.

HEADING SENSOR

TOOLS AND RESOURCES REQUIRED

- Drill
- #2 Screwdriver
- Awl or similar marking tool
- 1/4" Drill Bit
- 9/64" Drill Bit
- Marine-grade Silicone

INSTALLATION

MOUNTING OPTIONS

There are two options to install the Heading Sensor. Determine if the Power Cable for the Heading Sensor will pass below the mounting surface.

1. **Access under the Mounting Location** - When installing the Heading Sensor with this option, the Power Cables that come from the Heading Sensor will pass through the mounting surface. Only choose this option when the cables can be accessed after they are passed through the mounting surface. Follow the instructions in the Installation for Access Under the Mounting Location section of this instruction sheet.

2. **No Access under the Mounting Location** - The Power Cables for the Heading Sensor will be routed to the side because there is no room under the mounting location for the cables to pass, or the area below the mounting location is not accessible. Follow the instructions in the Installation for No Access Under the Mounting Location section of this instruction sheet.

It is important to review the mounting considerations and test run the Power Cable before installation.

Installation for Access Under the Mounting Location

1

ITEM(S) NEEDED



- Review the Mounting Considerations and then set the Heading Sensor (Item #2) flat on the selected mounting location and note the placement.
- Lift the Heading Sensor away and mark a point with an awl or similar marking tool beneath the mounting location for the power cable to pass through the surface.
- Using a drill with a 1/4" bit, drill a hole through the mounting location.
- Route the power cable through the drilled hole and feed the cable all the way through until the Heading Sensor sits flat on the mounting location and the cable is completely threaded through the drill hole.

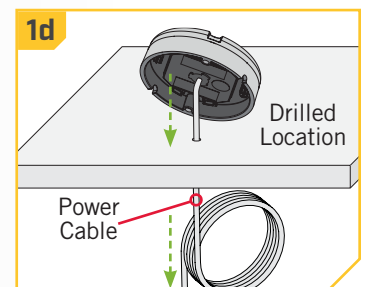
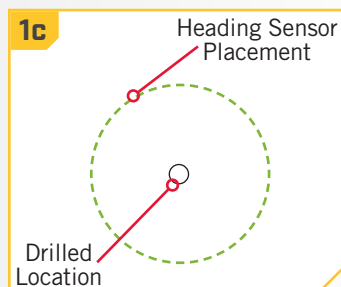
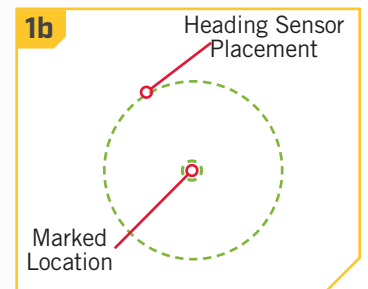
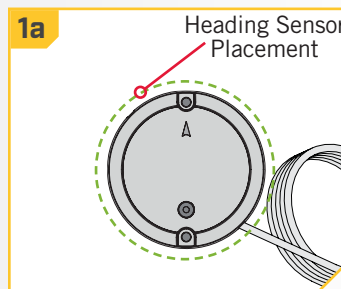

2

- e. Position the sensor so that the arrow on the cover is pointed toward the front of the boat in the direction of travel. **The arrow needs to be parallel with the keel of the boat.**

CAUTION

Failure to align the Heading Sensor correctly will result in incorrect compass readings.

- f. Mark the location of the two screw holes with an awl or similar marking tool.

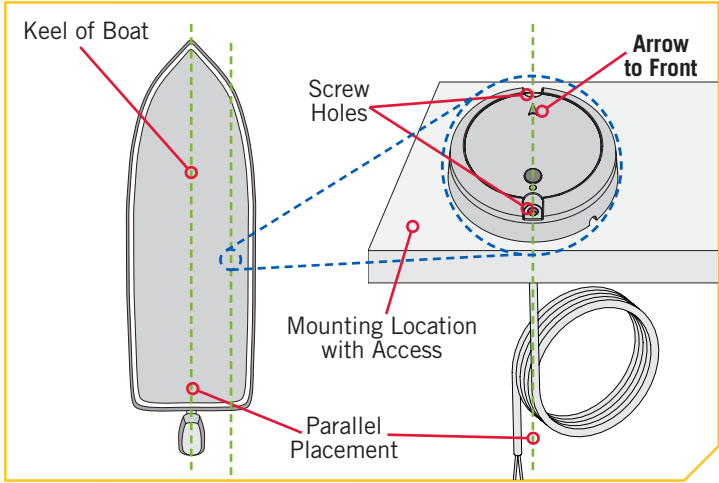

3

- g. Move the Heading Sensor to the side and drill two holes using a 9/64" drill bit on the marked locations.

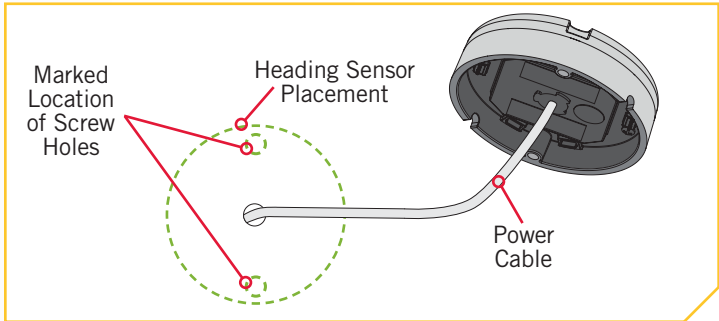

4

- h. Position the Heading Sensor back in place so that the holes drilled in the mounting location line up with the holes in the Heading Sensor and the Power Cable is completely threaded. **Be sure to mount the arrow towards the front of the boat and make the alignment parallel with the keel of the boat.**

CAUTION

Failure to align the Heading Sensor correctly will result in incorrect compass readings.

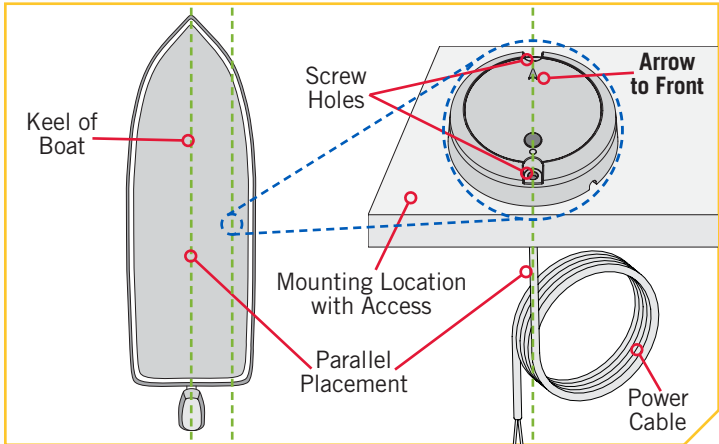

CAUTION

If the mounting surface is thin or made of a lightweight material, the mounting surface may need to be reinforced in order to support the Heading Sensor. Hand tighten the mounting screw to avoid over tightening and to prevent damage to the mounting location and Heading Sensor.

HEADING SENSOR

5

ITEM(S) NEEDED

 #1 x 2

- i. Apply a marine-grade silicone caulk or sealant to both #8 - 18x1-1/2 screws (Item #1) as needed to protect your boat from water damage.
- j. Using a #2 Screwdriver, mount the Heading Sensor to the mounting location using the two screws. Hand tighten only.

NOTICE: If replacement screws must be used, ensure that they are high grade non-magnetic stainless steel.

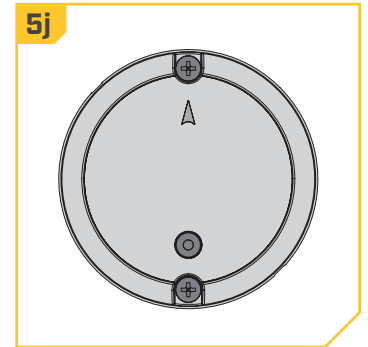
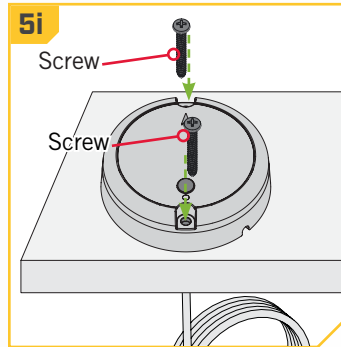

Installation for No Access Under the Mounting Location

1

ITEM(S) NEEDED

 #2 x 1

- a. Review the Mounting Considerations and then set the Heading Sensor (Item #2) flat on the mounting location and note its placement.
- b. Route the power cable through one of the two notches in the base of the Heading Sensor. When the arrow on the Heading Sensor is pointing towards the front of the boat, the cable should exit the Heading Sensor in the direction that is closest to its intended power source.

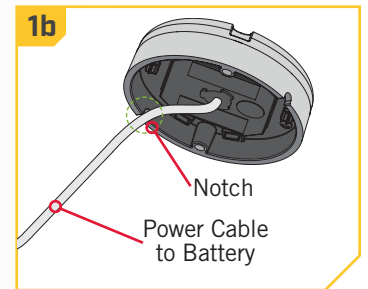
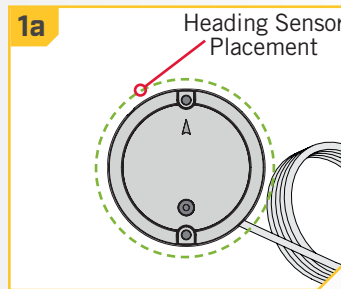

2

- c. Double check the position of the Heading Sensor so that the arrow on the cover is pointed toward the front of the boat in the direction of travel. **The arrow needs to be parallel with the keel of the boat.**

CAUTION

Failure to align the Heading Sensor correctly will result in incorrect compass readings.

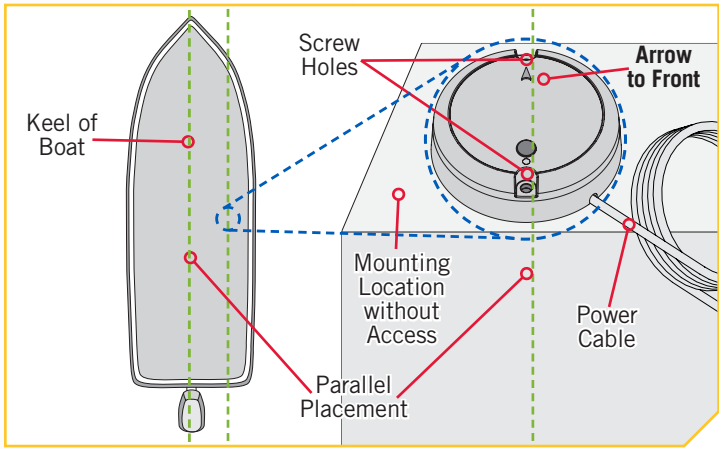

3

- d. Mark the location of the two screw holes with an awl or similar marking tool.
- e. Move the Heading Sensor to the side and drill two holes using a 9/64" drill bit on the marked locations.

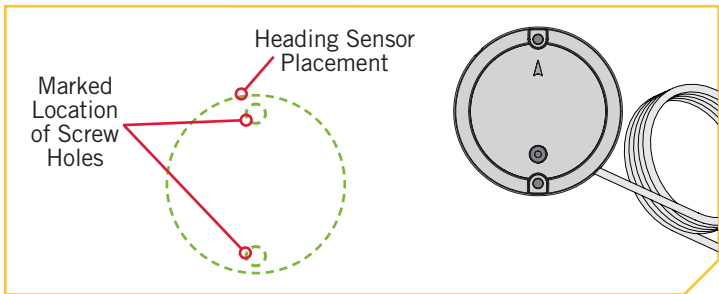

4

ITEM(S) NEEDED

#1 x 2

- f. Position the Heading Sensor back in place so that the holes drilled in the mounting location line up with the holes in the Heading Sensor. **Be sure to mount the arrow towards the front of the boat and make the alignment parallel with the keel of the boat.**
- g. Apply a marine-grade silicone caulk or sealant to both #8 - 18x1-1/2 screws (Item #1) as needed to protect your boat from water damage.

CAUTION

Failure to align the Heading Sensor correctly will result in incorrect compass readings.

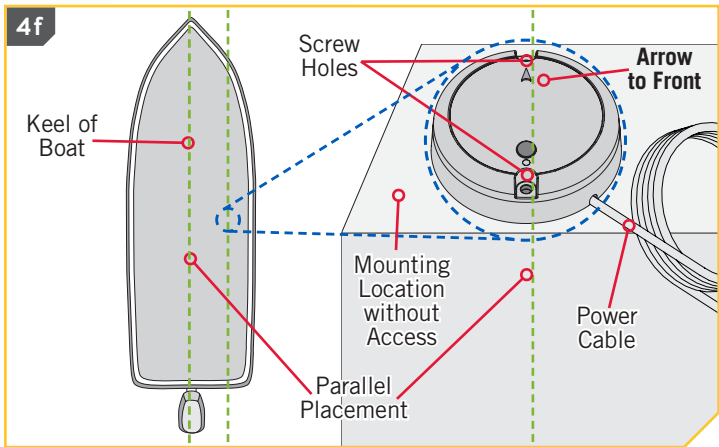

HEADING SENSOR

5

- f. Using a #2 Screwdriver, mount the Heading Sensor to the mounting location using the two screws. Hand tighten only.

CAUTION

If the mounting surface is thin or made of a lightweight material, the mounting surface may need to be reinforced in order to support the Heading Sensor. Hand tighten the mounting screw to avoid over tightening and to prevent damage to the mounting location and Heading Sensor.

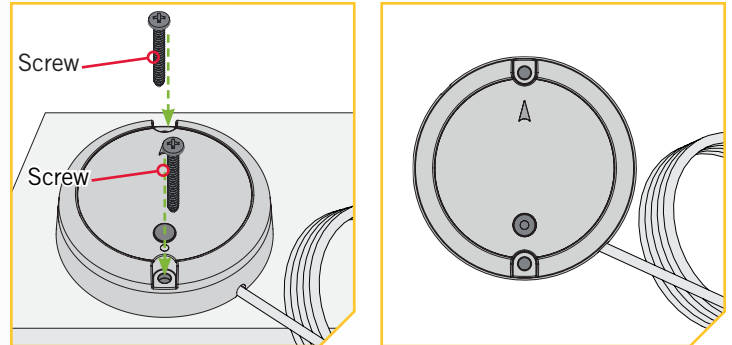

NOTICE: If replacement screws must be used, ensure that they are high grade non-magnetic stainless steel.

Connecting the Heading Sensor to a Power Source

The Heading Sensor is powered by a 12-volt power source. The Heading Sensor must be set up with a one amp fuse, either in-line, or connected to a fuse panel. To connect the Heading Sensor, please follow the directions below.

1. Connect positive (+) red lead to positive (+) power source terminal.
2. Connect negative (-) black lead to negative (-) power source terminal.

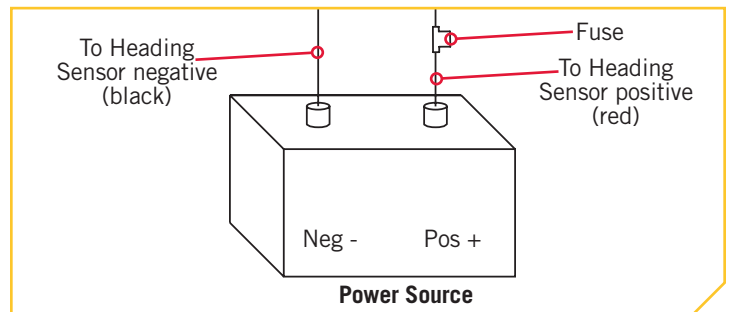

WARNING

Never connect the (+) and the (-) terminals of the same battery together. Take care that no metal object can fall onto the battery and short the terminals. This would immediately lead to a short and extreme fire danger.

WORKING WITH THE HEADING SENSOR >

> Pairing the Heading Sensor

Before the Heading Sensor can be paired, make sure that it has been properly installed and connected to a power source. Review the LED patterns that the Heading Sensor communicates in order to understand what mode it is in and to be able to recognize that it has successfully paired once the process is complete. To pair the Heading Sensor:

- 1
 - a. Connect the Heading Sensor to a power source. Verify that the LED on the Heading Sensor turns on for 3 seconds and then turns off.
 - b. Power on the trolling motor. Please see the trolling motor Owner's Manual for instructions on how to power up the trolling motor.
 - c. Press the Pair button on the Heading Sensor. Verify that the LED indicates it is attempting to pair.

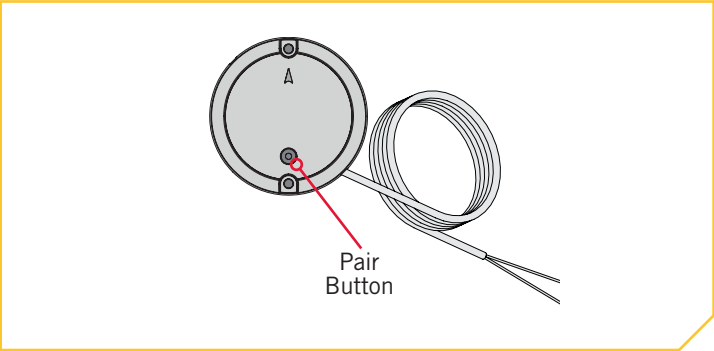

- 2
 - d. As quickly as possible, begin to hold the Pair button on the i-Pilot Control Head.
 - e. The i-Pilot Control Head will emit a beep pattern when the Heading Sensor is successfully paired. Release the Pair button on the Control Head. Watch the Heading Sensor to be sure that once it successfully pairs that it starts emitting the LED pattern for normal operation.
 - f. After the Heading Sensor is paired with i-Pilot or i-Pilot Link, proceed to Sensor Calibration and Sensor Offset.

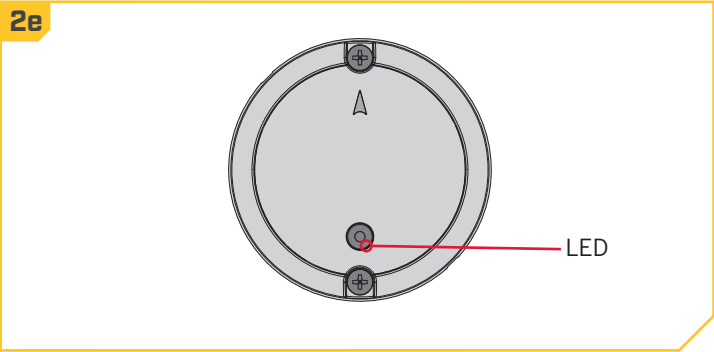
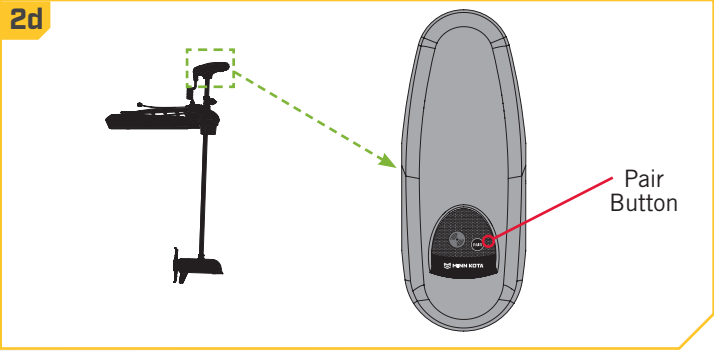

NOTICE: If battery power is lost, the Heading Sensor will not lose its Pairing to the i-Pilot System when it is powered down.

› Heading Sensor Calibration

The Heading Sensor calibration is initiated using either the i-Pilot or i-Pilot Link remote. Refer to the Owner's Manual for your motor if you are unsure of the i-Pilot system that comes with your motor. The process of calibrating the Heading Sensor must occur while your boat is on the water. Heading Sensor Calibration should always be performed after the trolling motor and Heading Sensor have been mounted, but before the Heading Sensor Offset is performed. The Heading Sensor must be connected to power and paired with the Control Head of the trolling motor before beginning this process. The calibration process requires the boat to be driven in two complete circles, so plan accordingly when preparing for this process. To complete this process, read all safety warnings and follow the procedure below.

WARNING

You are responsible for the safe and prudent operation of your vessel. We have designed your Minn Kota product to be an accurate and reliable tool that will enhance boat operation and improve your ability to catch fish. This product does not relieve you from the responsibility for safe operation of your boat. You must avoid hazards to navigation and always maintain a permanent watch so you can respond to situations as they develop. You must always be prepared to regain manual control of your boat. Learn to operate your Minn Kota product in an area free from hazards and obstacles.





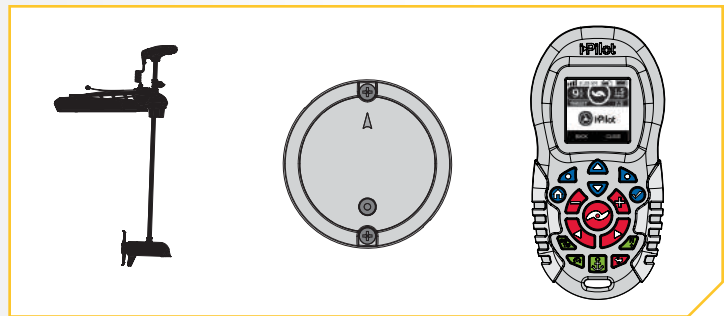

WARNING

Take care that neither you nor other persons approach the turning propeller too closely, neither with body parts nor with objects. The motor is powerful and may endanger or injure you or others. While the motor is running watch out for persons swimming and for floating objects. Persons whose ability to run the motor or whose reactions are impaired by alcohol, drugs, medication, or other substances are not permitted to use this motor.

- 1**
 - a. Review all safety warnings and then navigate your boat to an area of the water that is free from obstructions.
 - b. Power up the trolling motor according to the instructions provided in the Owner's Manual. Make sure the Heading Sensor is also powered up and paired with the trolling motor.
 - c. Turn on the remote for your i-Pilot system.



2

- d. On the i-Pilot remote, use the Menu Up  and Menu Down  buttons to find the System menu at the bottom of the display screen.
- e. Use the Right Softkey  to select the System menu.
- f. Use the Menu Up  and Menu Down  buttons to find the Sensor Cal menu at the bottom of the display screen. Use the Ok  button to select it.
- g. The Sensor Cal screen will display.

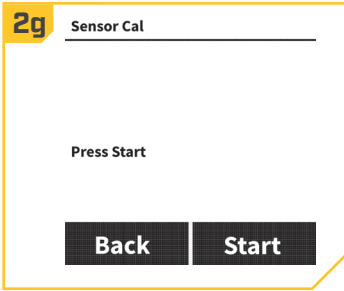
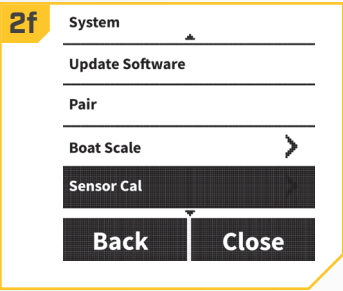
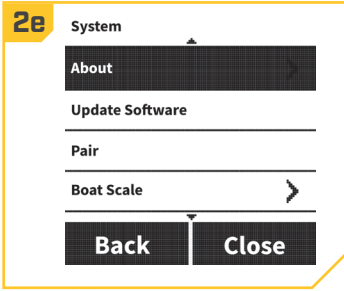
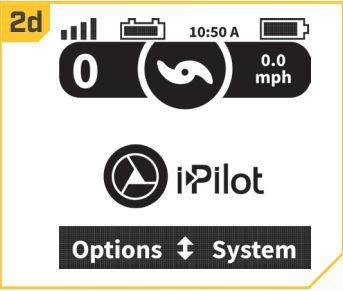





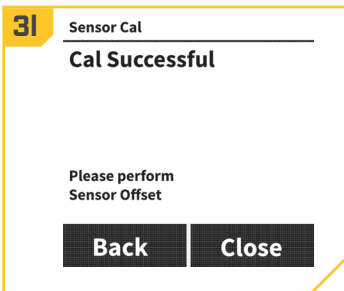
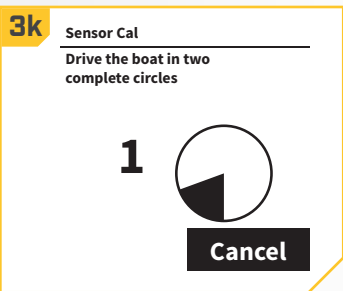
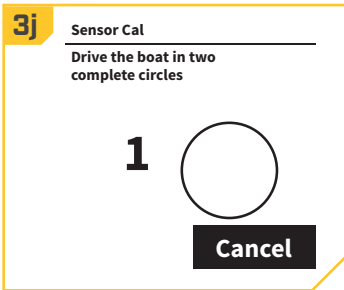
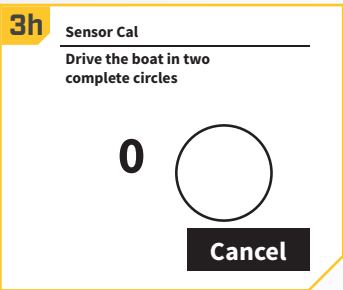

3

- h. Use the Right Softkey  to select the Start menu.
- i. Review all safety warnings and then follow the prompts on the display screen and drive the boat in two complete circles.
- j. The left side of the Display Screen contains a counter that shows the number of complete turns that the boat has been driven and will increase from 0 to 1 and 2 as the circles are complete.
- k. The Circle on the right side of the display screen will show how complete the boat has progressed through the current circle and will fill in like a pie chart as the boat progresses.
- l. Once the two complete circles have been completed, the display screen will read Cal Successful.





Heading Offset

Once the Heading Sensor is calibrated, the Heading Offset needs to be set. Heading Offset is the difference between the angle of the Keel of the boat and the angle that the Heading Sensor is mounted to the deck of the boat. During installation, the Heading Sensor was installed to be as parallel to the Keel of the boat as possible. If the boat and Heading Sensor are perfectly parallel and pointing in exactly the same direction, the Offset will be a perfect 0° degrees. Knowing that installations are never perfect, the Heading Offset can be set on the i-Pilot remote to compensate for the difference between the two. Heading Offset has the ability to correct the difference in measurement in a range between +30° and -30° degrees.

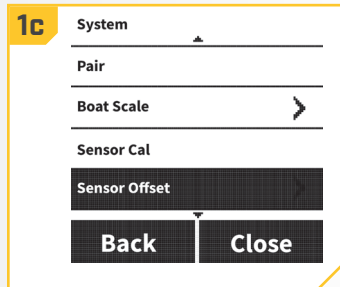
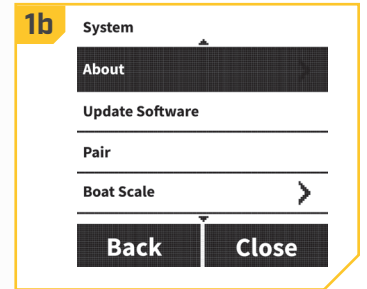
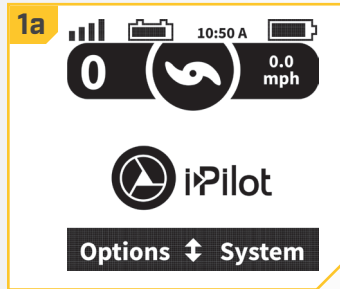
- 1
 - a. On the i-Pilot remote, use the Menu Up  and Menu Down  buttons to find the System menu at the bottom of the display screen.
 - b. Use the Right Softkey  to select the System menu.
 - c. Use the Menu Up  and Menu Down  buttons to find the Sensor Offset menu at the bottom of the display screen. Use the Ok  button to select it.
 - d. The Sensor Offset screen will display.





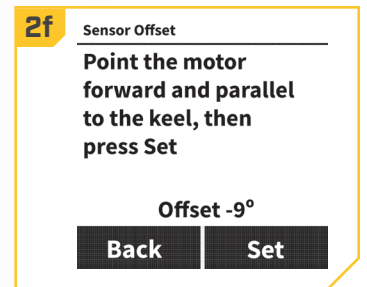
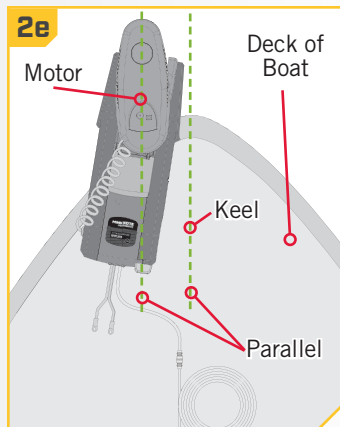



- 2
 - e. Turn the motor so that it is parallel with the Keel of the boat.
 - f. Use the Right Softkey  to select the Set menu.
 - g. The Sensor Offset will automatically adjust. Use the Left Softkey  to select Back, or press the Home  button to exit the menu.



MOTOR CONTROLS

▶ To Toggle the Prop Auto On

1

- Press the Home  button.
- Use the Menu Up  and Menu Down  buttons to find the Options menu at the bottom of the display screen.
- Use the Left Softkey  to select the Options menu.
- In the Options menu, use the Menu Up  and Menu Down  buttons to find the Prop Auto On selection.

NOTICE: When the box next to Prop Auto ON is marked with an X, the prop will turn "on" when navigation features are used. By default the box is not marked.

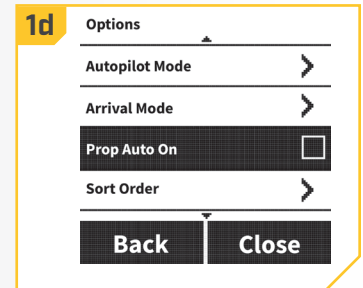
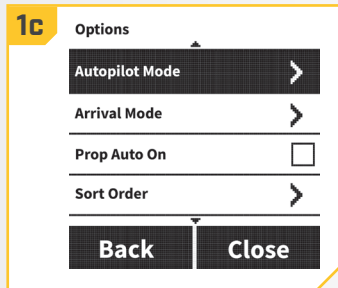
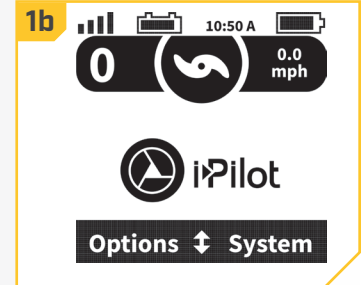
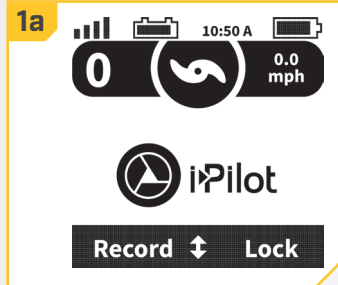



2

- By default, the Prop Auto On is toggled "off".
- To toggle the Prop Auto On, scroll to it in the menu and press the Ok  button to select it.



WARNING

When the Prop Auto On is toggled "on", the prop will turn on when navigation features are used. Navigation features include working with iTracks and AutoPilot. Be sure that the prop is clear from obstructions and hazards when using navigation features.

NOTICE: Prop Auto On is not the same as the Prop ON/OFF  button. Prop Auto On will affect navigational features. The Prop ON/OFF  button refers to the prop status during normal use. If the Prop Auto On feature is engaged, the Prop ON/OFF  button is still functional.

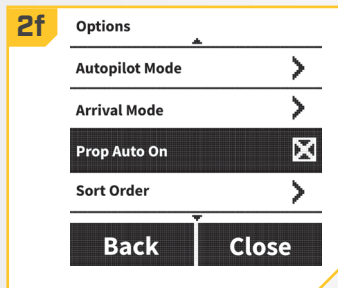

NOTICE: Prop Auto On does not affect the Prop when Cruise Control is being used, or when High Speed Bypass is engaged. If Prop Auto On is not working as expected, check the motor speed. The propeller will turn at the current speed setting when Prop Auto On is engaged. If the Prop Auto on feature turns the prop on, and the propeller is not turning, the speed may be set to zero. Prop Auto On only engages when navigational features, such as navigating to an iTrack or Spot-Lock, are first engaged.







Adjusting Boat Scale

Ideal installation for a trolling motor is to have the proper amount of thrust for the size of the boat the trolling motor is being installed on. If the motor thrust is not properly matched to the boat size, Boat Scale can be used to compensate for the mis-match. The default is zero, assuming that the boat and trolling motor thrust are properly matched. For an installation where the motor thrust is undersized for the boat, increase the Boat Scale. For installation where the motor thrust is oversized for the boat, decrease Boat Scale.



Thrust requirements are determined by the size and weight of your boat. Minn Kota suggests selecting a trolling motor with at least 2 lbs. of thrust for every 100 lbs. of boat weight when the boat is fully loaded with fuel, people, tackle, etc. This guide is established under normal lake fishing conditions and should be used as a general guide to determine how ideally the thrust of your trolling motor is matched to the weight of your boat.

Boat Weight in Pounds	Suggested MINIMUM Trolling Motor Size in Pounds of Thrust	Voltage	Max Boat Length
1,500 or below	30	12	14'
2,000	40 - 45	12	17' - 18'
2,500	50 - 55	12	20' - 21'
3,000 - 3,500	70	24	23'
4,000	80	24	25'
4,500 - 5,000	101 - 112	36	25'

1

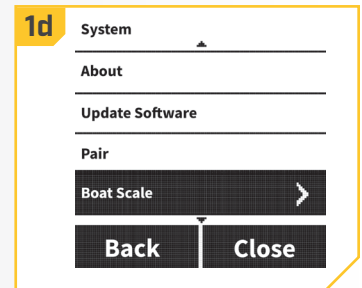
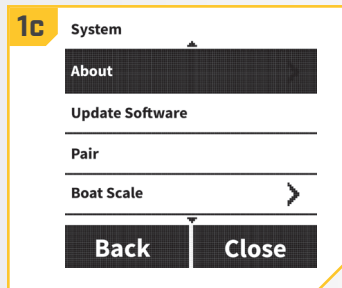
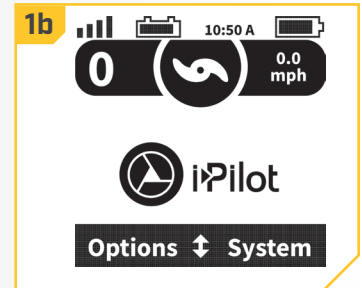
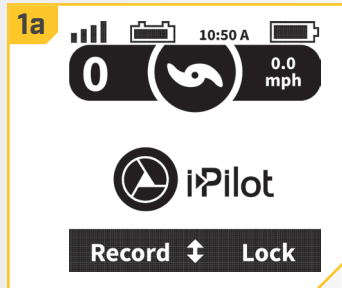

- Press the Home  button.
- Use the Menu Up  and Menu Down  buttons to find the System menu at the bottom of the display screen.
- Use the Right Softkey  to select the System menu.
- Use the Menu Up  and Menu Down  buttons to find the Boat Scale menu. Use the Ok  button to select it.

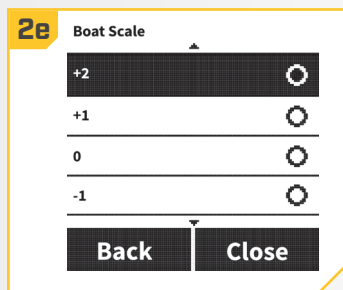

- 2**
- e. Use the Menu Up  and Menu Down  buttons to scroll to +2, +1, 0, -1, or -2.
 - f. Use the Ok  button to select the option highlighted. The circle to the right of the selected Boat Scale will become solid when selected.



› Deploying the Motor ♦

- 1**
- a. Press the Home  button.
 - b. Use the Menu Up  and Menu Down  buttons to find the Deploy menu at the bottom of the display screen.

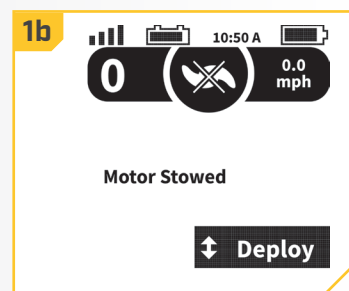
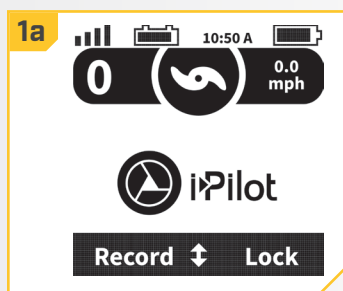

NOTE: The Deploy menu at the bottom of the display screen can only be found when the motor is stowed.



- 2**
- c. Use the Right Softkey  to select the Deploy menu by double pressing it. Once selected the motor will automatically deploy.

WARNING

As soon as the Deploy menu is selected, the motor will automatically deploy. Be sure the motor is clear from obstructions and has a clear path of travel. The Prop is disabled while the motor is stowed and being deployed to prevent accidental contact with the rotating propeller.

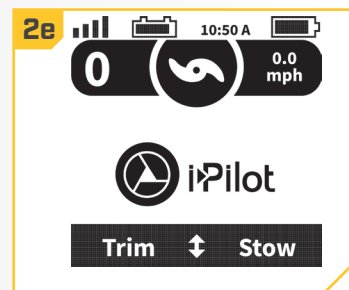
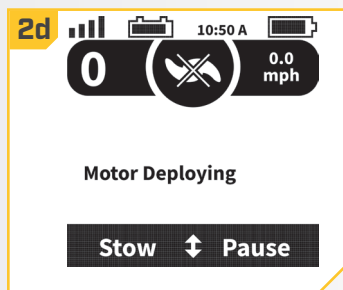

- d. While the Motor is deploying, it is possible to stop the action. Use either the Left Softkey  to select the Stow menu or the Right Softkey  to select the Pause menu.
- e. If the Motor continues, it will complete the deploy process, normal motor operation will follow.



♦ Only available with Ulterra.

› Stowing the Motor ◊

1

- a. Press the Home  button.
- b. Use the Menu Up  and Menu Down  buttons to find the Stow menu at the bottom of the display screen.

NOTICE: The Stow menu at the bottom of the display screen can only be found when the motor is deployed.

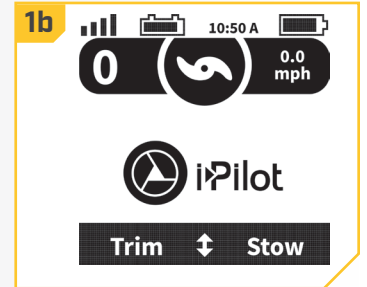
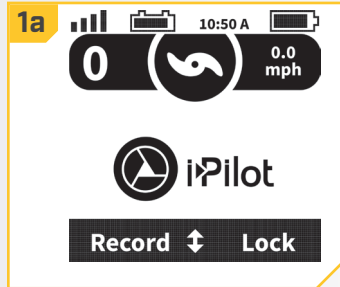



2

- c. Use the Right Softkey  to select the Stow menu. Once selected the motor will automatically stow.

WARNING

As soon as the Stow menu is selected, the motor will automatically stow. Be sure the motor is clear from obstructions and has a clear path of travel. The Prop is disabled while the motor is being stowed to prevent accidental contact with the rotating propeller.



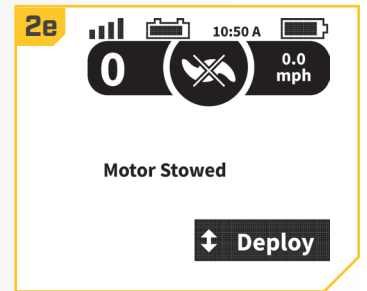
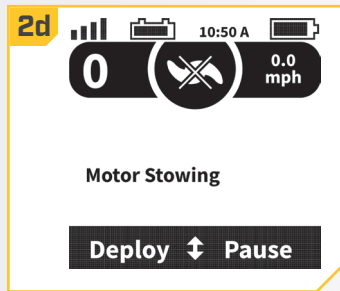



- d. While the Motor is stowing, it is possible to stop the action. Use either the Left Softkey  to select the Deploy menu or the Right Softkey  to select the Pause menu.
- e. If the Motor continues, it will complete the Stow process and the Prop will be disabled.



◊ Only available with Ulterra.

Adjusting Trim ♦

1

- a. Press the Home  button.
- b. Use the Menu Up  and Menu Down  buttons to find the Trim menu at the bottom of the display screen.
- c. Use the Left Softkey  to select the Trim menu.
- d. Use the Menu Up  and Menu Down  buttons to adjust the Boat Trim.
- e. When the motor has reached its highest Trim limit, the Prop will be locked out.
- f. The Prop will stay locked out even when the Trim Motor screen has closed and the motor has not been trimmed down.

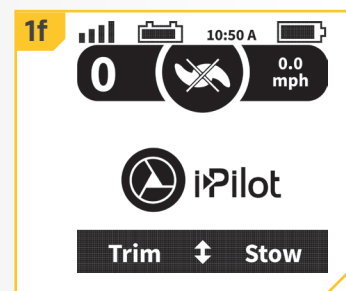
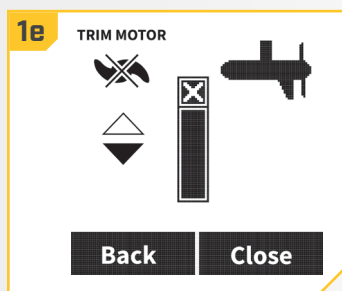
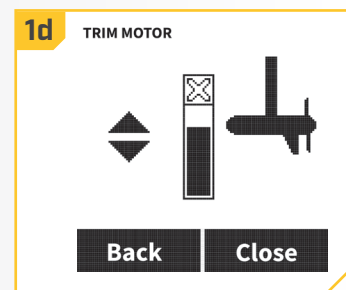
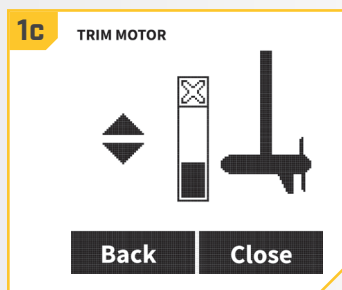
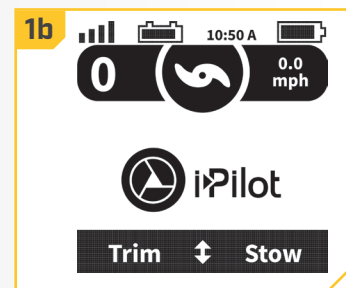
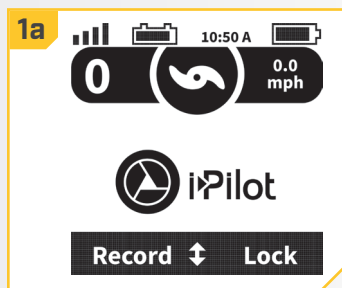

♦ Only available with Ulterra.