

# ONE-BOAT NETWORK

## OPTIMIZING THE PERFORMANCE OF THE RIPTIDE INSTINCT QUEST WITH THE WIRELESS REMOTE OR ONE-BOAT NETWORK APP

Minn Kota® and Humminbird® have joined forces to bring you the One-Boat Network, including the latest Advanced GPS Navigation Wireless Remote and the One-Boat Network app. The Wireless Remote comes from the factory paired to the trolling motor. To learn more about Wireless Remote features, refer to the Wireless Remote Owner's Manual online at [minnkota.johnsonoutdoors.com](http://minnkota.johnsonoutdoors.com).

To get the most from your One-Boat Network, we encourage you to download the One-Boat Network app onto your smart device. The One-Boat Network® app is a free iOS and Android application that you can download to a mobile device, providing unparalleled control over all of your One-Boat Network connected products. Minn Kota recommends connecting the trolling motor to the OBN app to assist in these steps. For instructions on pairing the OBN app to the trolling motor, refer to the OBN Quick Start Guide included with the motor. For more information on the OBN app, refer to the One-Boat Network Owner's Manual online at [minnkota.johnsonoutdoors.com](http://minnkota.johnsonoutdoors.com).

Completing the installation of the Riptide Instinct QUEST through the Wireless Remote or OBN app should be done following the Prop installation. Ensure that the trolling motor is connected to a power source before adjusting One-Boat Network settings.

### **WARNING**

Take care that neither you nor other persons approach the turning propeller too closely, neither with body parts nor with objects. The motor is powerful and may endanger or injure you or others. Stay clear of the Prop and watch out for accidental engagement.

**NOTICE:** Ensure that the trolling motor is connected to a power source before adjusting One-Boat Network settings.

**NOTICE:** If the Wireless Remote is lost or becomes non-functioning during navigation, and the One-Boat Network app is unavailable, disconnect the motor from power to cancel all active navigation and turn off the Prop.

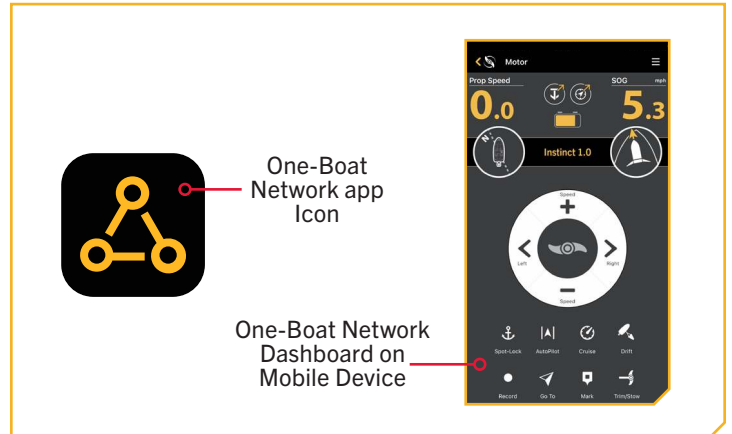

# ONE-BOAT NETWORK ADJUSTMENTS

## ONE-BOAT NETWORK ADJUSTMENTS



### KEEL OFFSET

The Riptide Instinct QUEST comes from the factory with the Lower Unit parallel to the Mount. When the Lower Unit is parallel to the Mount, the Keel Offset is zero. In an ideal installation, the Lower Unit will be parallel to the Keel; however, the Mount is rarely installed to be perfectly in line with the Keel, therefore the Lower Unit will not be parallel with the Keel. Nearly all installations will have some variation in mounting position to either the Port or Starboard side of the boat. The Keel Offset feature records the position of the Lower Unit when it is parallel to the Keel based on the Mount being offset from the Keel. Before adjusting the Keel Offset, complete all installation steps. This includes mounting the trolling motor to the boat and installing power and accessory cables. The Keel Offset can be recorded through the Wireless Remote or One-Boat Network App.

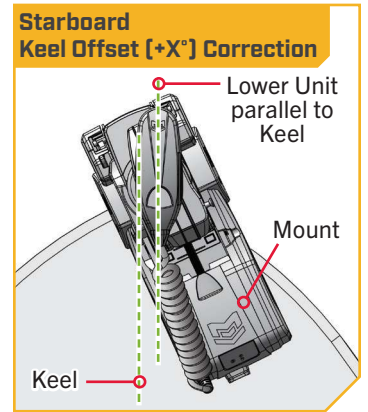
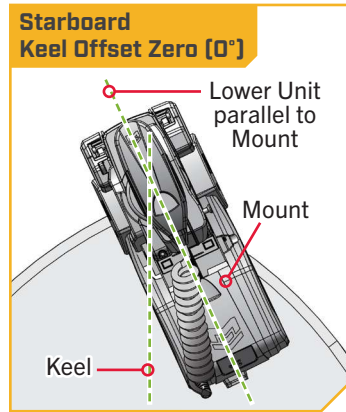
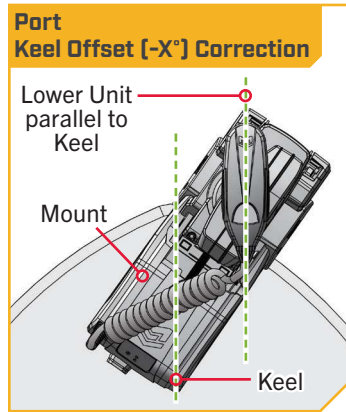
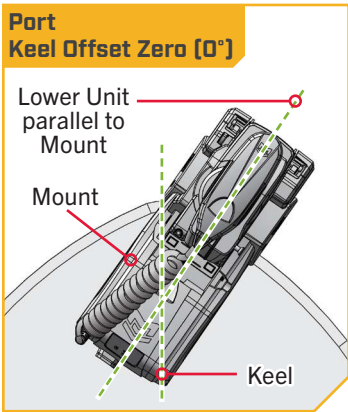
**NOTICE:** When the motor is installed from the factory, the Keel Offset is 0 degrees. When adjusting the Keel Offset, any position towards Port will create a Keel Offset of a negative angle. Any position towards Starboard will create a positive angle.







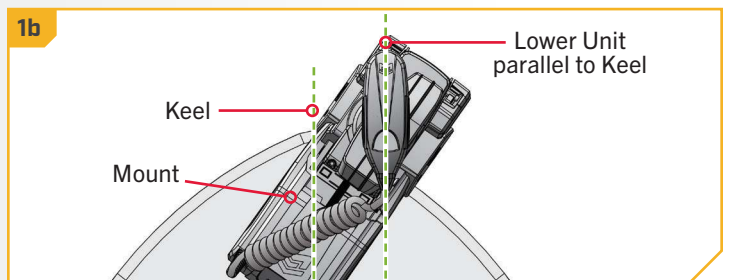
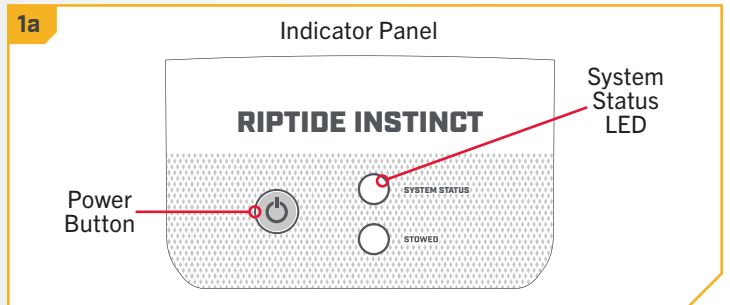



### Setting the Keel Offset with the Wireless Remote

- 1
  - a. Power on the trolling motor by pressing the Power  button on the Indicator Panel. When the trolling motor is on, the System Status  LED will be blue.
  - b. With either the Wireless Remote or One-Boat Network (OBN) app on a paired mobile device, steer the motor so that the control head and lower unit are parallel to the Keel.







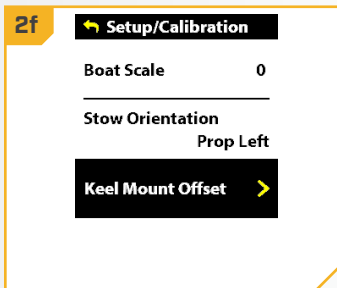
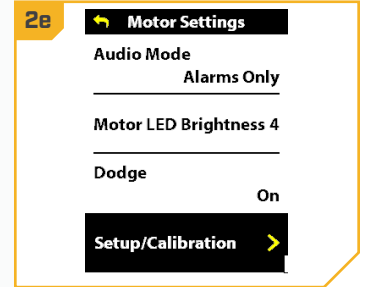
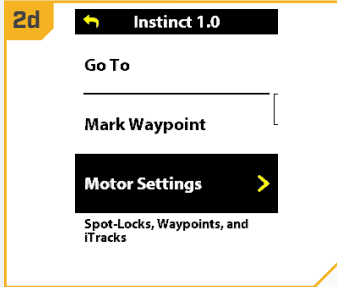

## 2

- c. Press the Menu  button on the Wireless Remote.
- d. Use the Speed Up  or Speed Down  button to find the Motor Settings menu. Use the Steer Right  button to select Motor Settings.
- e. In the Motor Settings Menu, use the Speed Up  or Speed Down  button to find Setup/Calibration.
- f. In the Setup/Calibration menu, use the Speed Up  or Speed Down  button to find Keel Mount Offset. Use the Steer Right  button to select Keel Mount Offset.



## 3

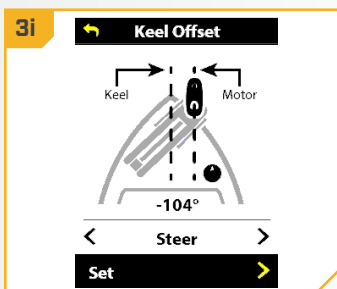
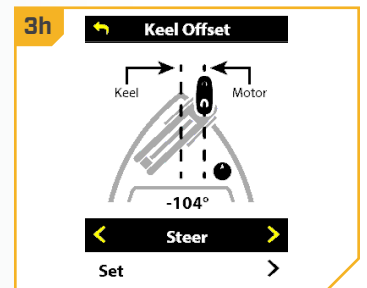
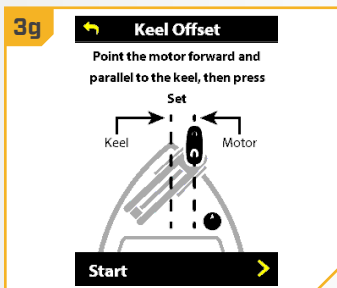

- g. Review all safety warnings. Use the Steer Right  button to select Start and begin the process.
- h. Use the Steer Left  or Steer Right  button to point the motor forward and parallel to the keel.
- i. When satisfied with the placement of the trolling motor, use the Speed Up  or Speed Down  button to scroll to Set. Use the Steer Right  button to select Set. The degree of offset is displayed at the bottom of the Dashboard.



# KEEL OFFSET

## ▶ Setting the Keel Offset with the One-Boat Network App

1

- Power on the trolling motor by pressing the Power  button on the Indicator Panel. When the trolling motor is on, the System Status  LED will be blue.
- With either the Wireless Remote or One-Boat Network (OBN) app on a paired mobile device, steer the motor so that the control head and lower unit are parallel to the Keel.

1a

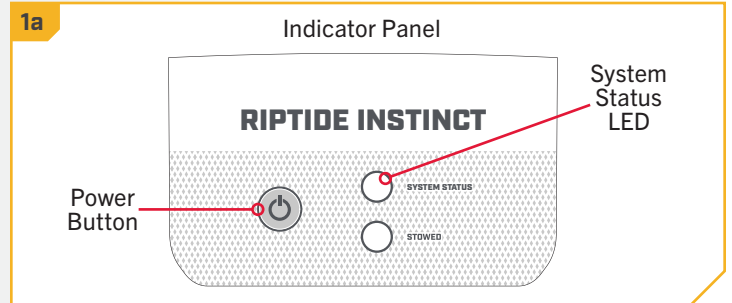

1b

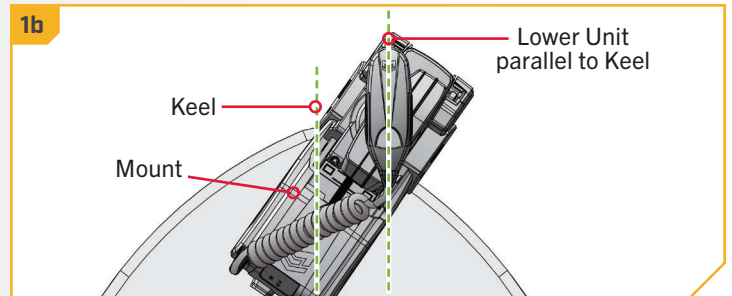

2

- Open the One-Boat Network (OBN) app on the mobile device. Make sure the mobile device is paired with the trolling motor.
- From the OBN home screen, tap the Motor menu. The Motor menu opens the Motor home screen.
- Before the Motor home screen will open, tap Agree on the on-screen prompt.

**NOTICE:** The on-screen prompt will only display once each time the app is launched. If the prompt has displayed, the Motor home screen appears.

- On the Motor home screen, locate the Motor Settings button in the upper-right corner and tap it.

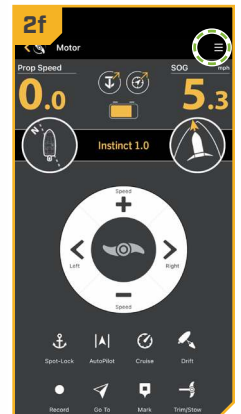
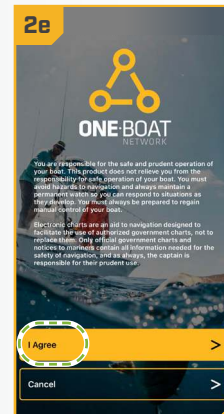
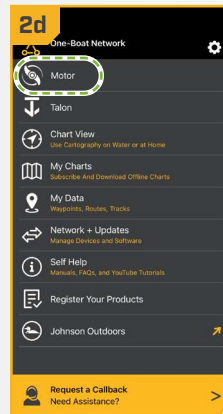

## 3

- g. In the Motor Settings menu, find and tap Setup and Calibration.
- h. In Setup and Calibration, find and tap Keel Mount Offset.
- i. Review all safety warnings. Follow the prompts in the One-Boat Network app. If the placement of the trolling motor is pointing forward and parallel to the keel, tap Set. The degree of offset will show at the bottom of the app Display.

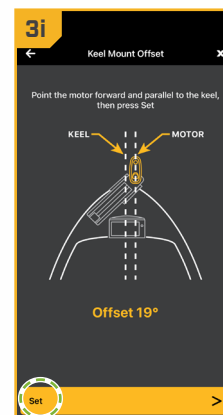
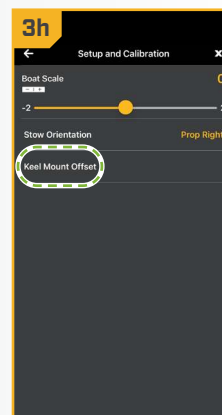
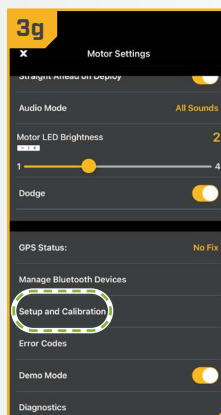

## 4

- j. If the trolling motor needs to be adjusted, locate the Return button on the upper-left corner of the app screen. Tap the Return button three times until the Motor home screen displays.
- k. Use the Steer Right > and Steer Left < buttons to point the motor forward and parallel to the keel.
- l. When satisfied with the placement of the trolling motor, locate the Motor Settings button in the upper-right corner and tap it.
- m. In the Motor Settings menu, find and tap Setup and Calibration.
- n. In Setup and Calibration, find and tap Keel Mount Offset. If the placement of the trolling motor is pointing forward and parallel to the keel, tap Set.
- o. The degree of offset shows at the bottom of the app Display. Tap Return to close the Keel Mount Offset and return to the home screen.

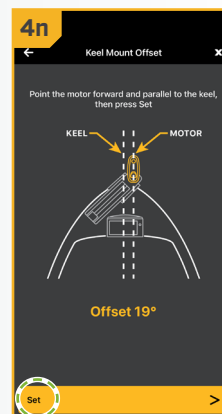
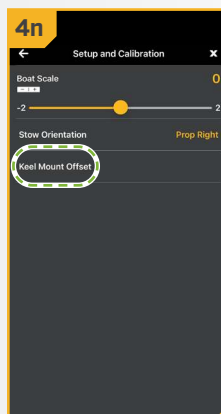
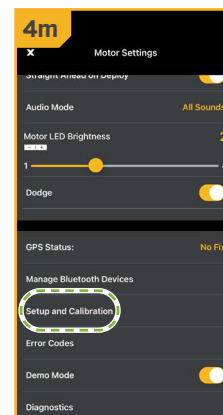
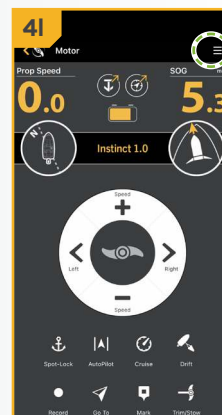
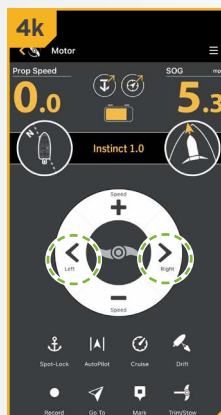

# STRAIGHT ON DEPLOY





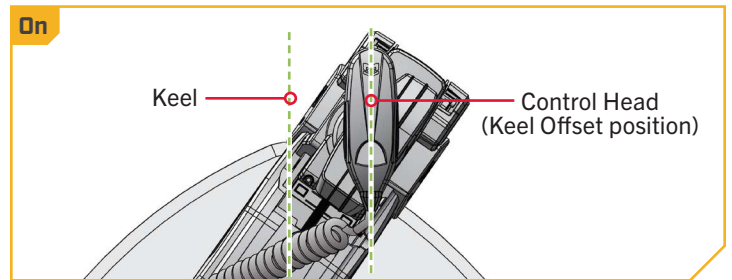
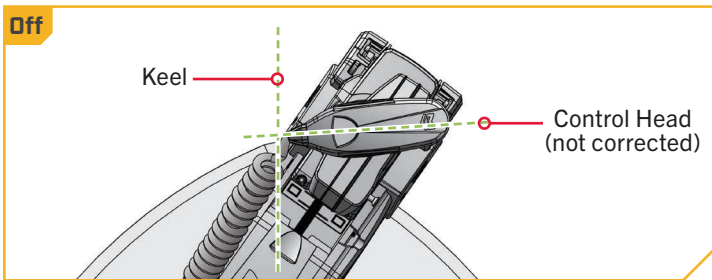

## STRAIGHT ON DEPLOY

Minn Kota recommends setting the Keel Offset when the position of the Lower Unit is parallel with the Keel. Save the Keel Offset before exploring the Straight on Deploy feature. Straight on Deploy uses the position recorded in Keel Offset to know where to position the Lower Unit to be parallel with the Keel.

When Straight on Deploy is engaged, the lower unit will automatically rotate to the Keel Offset position when deployed. By default, the Lower Unit will be parallel to the Keel when the Mount is parallel to the Keel. If the Keel Offset was programmed to another angle, the Straight on Deploy feature will correct the position to match the Keel Offset angle when turned "on." If Straight on Deploy is turned "off," the trolling motor will not correct the position in any direction.



### › To Toggle Straight on Deploy with the Wireless Remote

- 1 a. With the motor on, press the Menu  button on the Wireless Remote.
- b. Use the Speed Up  or Speed Down  button to find the Motor Settings menu. Use the Steer Right  button to select Motor Settings.
- c. In the Motor Settings Menu, use the Speed Up  or Speed Down  button to find Straight on Deploy.
- d. By default, the Straight on Deploy is toggled "off."
- e. Use the Steer Right  button to toggle between "on" and "off."

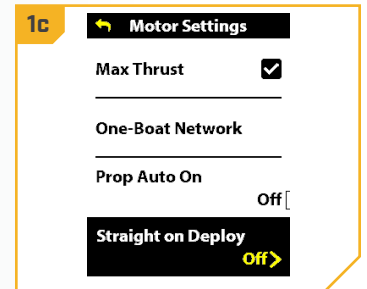
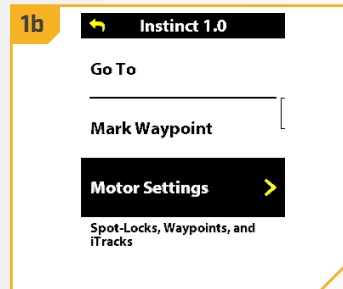

» To Toggle Straight on Deploy with the One-Boat Network App

1

- a. Open the One-Boat Network (OBN) app on a mobile device. Make sure the mobile device is paired with the trolling motor and that the motor is powered "on."
- b. From the OBN home screen, tap the Motor menu. The Motor menu opens the Motor home screen.
- c. Before the Motor home screen will open, tap Agree on the on-screen prompt.

**NOTICE:** The on-screen prompt will only display once each time the app is launched. If the prompt has displayed, the Motor home screen appears.

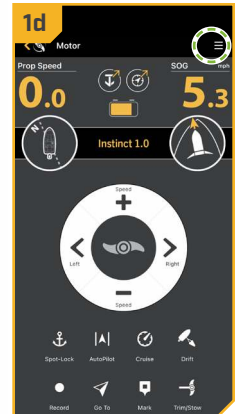
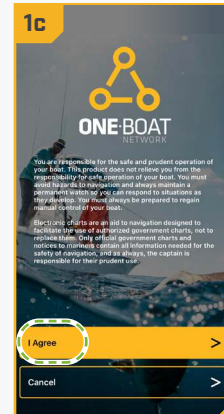
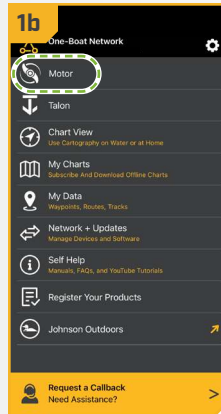

- d. On the Motor home screen, locate the Motor Settings button in the upper-right corner and tap it.

2

- e. In the Motor Settings menu, find the Straight Ahead on Deploy toggle. Tap to turn the toggle "on" and "off." When highlighted yellow the toggle is "on."

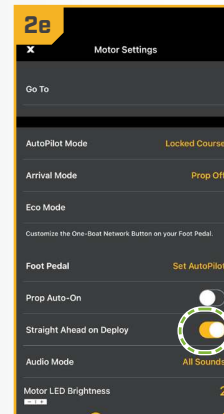
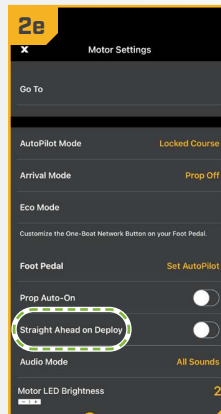

# STOW ORIENTATION

## STOW ORIENTATION

The Stow Orientation is a term used to describe the lower unit and Prop position when the motor is stowed. The lower unit will automatically rotate into the Stow Orientation when stowing the motor. The Stow Orientation can be set to Prop Left or Prop Right through the Wireless Remote or One-Boat Network app. The factory default setting for the lower unit is Prop Left. Adjusting the Stow Orientation allows the installation to be customized to fit boat positioning for either a Port or Starboard installation and to accommodate fishing or trailering applications.

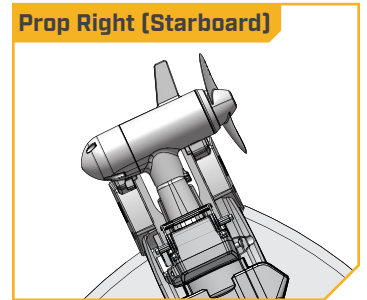
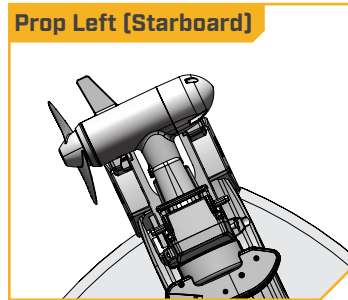
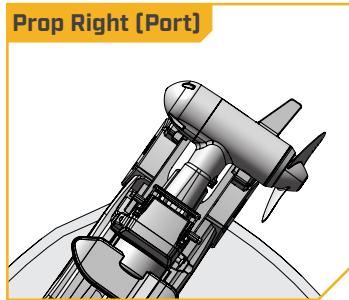
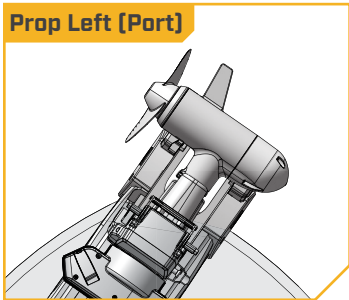

### Setting the Stow Orientation with the Wireless Remote

- 1**
  - a. With the trolling motor powered on, press the Menu button on the Wireless Remote.
  - b. Use the Speed Up or Speed Down button to find the Motor Settings menu. Use the Steer Right button to select Motor Settings.
  - c. In the Motor Settings Menu, use the Speed Up or Speed Down button to find Setup/Calibration. Use Steer Right to open the Setup/Calibration menu.

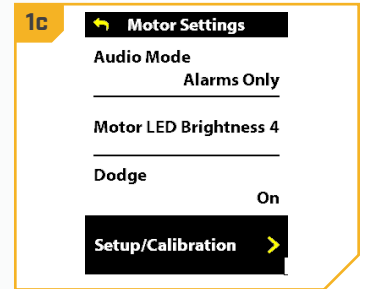
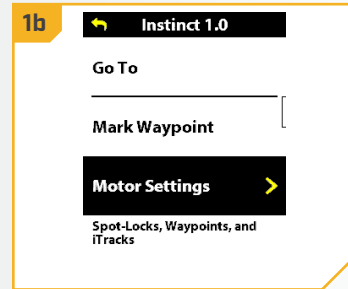

- 2**
  - d. Once in the Setup/Calibration menu, use the Speed Up or Speed Down button to find Stow Orientation. Use Steer Right to open the Stow Orientation menu.
  - e. In the Stow Orientation menu, use the Speed Down or Speed Up button to scroll between Prop Left and Prop Right. Use the Steer Right button to select the desired stow orientation.

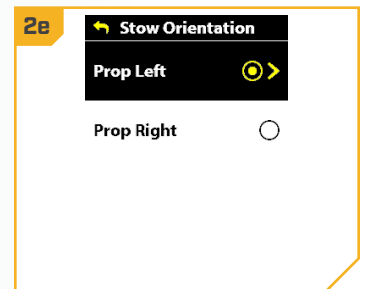
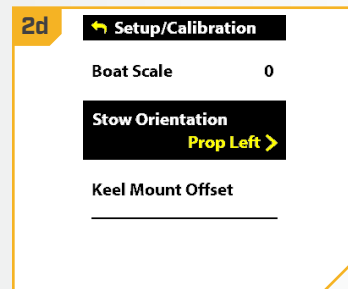



➤ Setting the Stow Orientation with the One-Boat Network App

- 1**
- Open the One-Boat Network (OBN) app on a mobile device. Make sure the mobile device is paired with the trolling motor and that the motor is powered "on."
  - From the OBN home screen, tap the Motor menu. The Motor menu opens the Motor home screen.
  - Before the Motor home screen will open, tap Agree on the on-screen prompt.

**NOTICE:** The on-screen prompt will only display once each time the app is launched. If the prompt has displayed, the Motor home screen appears.

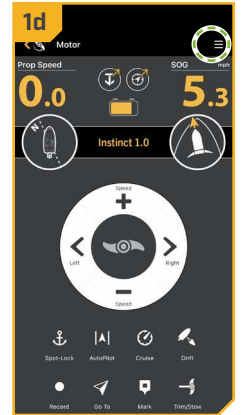
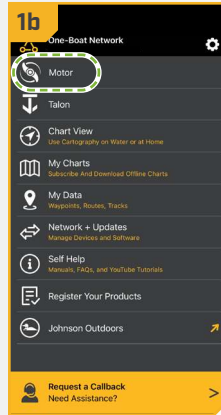

- On the Motor home screen, locate the Motor Settings button in the upper-right corner and tap it.

- 2**
- In the Motor Settings menu, find and tap Setup and Calibration.
  - In Setup and Calibration, find and tap Stow Orientation.
  - Set the feature to Prop Right or Prop Left.

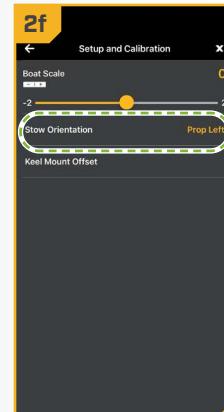
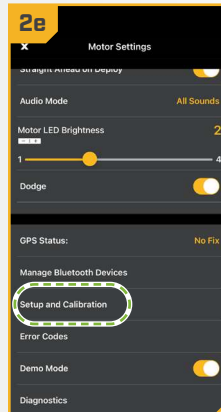







# BOAT SCALE

## BOAT SCALE





Trolling motor performance can be impacted by factors including, but not limited to, wind, water conditions, boat specifications, battery health, wiring, etc. Boat Scale provides a method of adjusting how the trolling motor will perform to account for these and other variables. The Riptide Instinct QUEST comes from the factory with Boat Scale set to zero. Boat Scale can be adjusted up (+2) or down (-2) to increase or decrease how the motor control software applies power while using a navigation mode like Spot-Lock.

An example showing the need to reduce Boat Scale would be while using Spot-Lock and the motor is over-correcting or making frequent adjustments. In this case, try reducing Boat Scale -1 to reduce this behavior. If the behavior continues, reduce Boat Scale to -2. An example showing the need to increase Boat Scale while using Spot-Lock would be the motor is drifting away from its target location frequently or needs help to make corrections. Try increasing Boat Scale to +1 to help improve the trolling motor accuracy in this case. If the behavior continues, increase Boat Scale to +2.

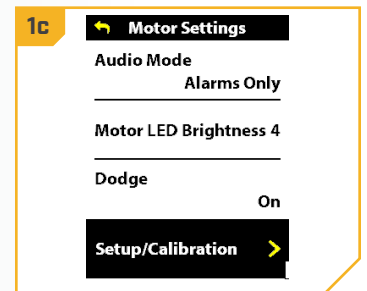
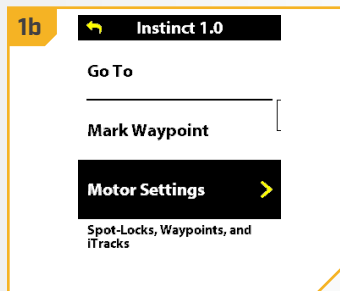
### Adjusting Boat Scale with the Wireless Remote

- 1**
  - a. With the motor on, press the Menu  button on the Wireless Remote.
  - b. Use the Speed Up  or Speed Down  button to find the Motor Settings menu. Use the Steer Right  button to select Motor Settings.
  - c. In the Motor Settings Menu, use the Speed Up  or Speed Down  button to find Setup/Calibration.



- 2**
  - d. Once in the Setup/Calibration menu, use the Speed Up  or Speed Down  button to find Boat Scale.
  - e. Use the Steer Left  or Steer Right  button to adjust the Boat Scale to one of the five settings: -2, -1, 0, 1 or 2.

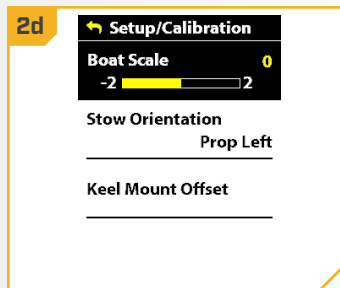

## Adjusting Boat Scale with the One-Boat Network App

1

- Open the One-Boat Network (OBN) app on a mobile device. Make sure the mobile device is paired with the trolling motor and that the motor is powered "on."
- From the OBN home screen, tap the Motor menu. The Motor menu opens the Motor home screen.
- Before the Motor home screen will open, tap Agree on the on-screen prompt.

**NOTICE:** The on-screen prompt will only display once each time the app is launched. If the prompt has displayed, the Motor home screen appears.

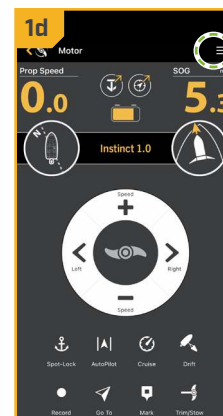
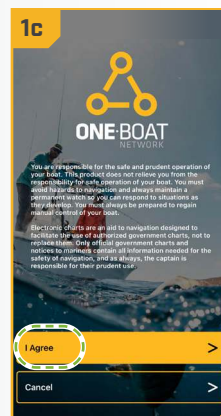
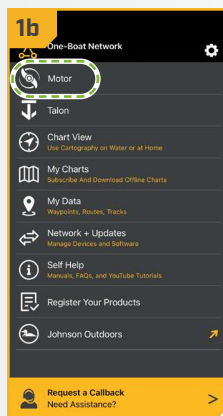

- On the Motor home screen, locate the Motor Settings button in the upper-right corner and tap it.

2

- In the Motor Settings menu, find and tap Setup and Calibration.
- In Setup and Calibration, find and tap Boat Scale.
- Set the feature to increase or decrease Boat Scale.

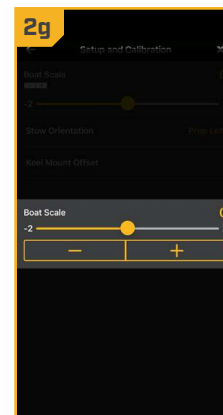
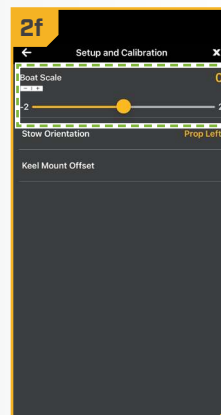
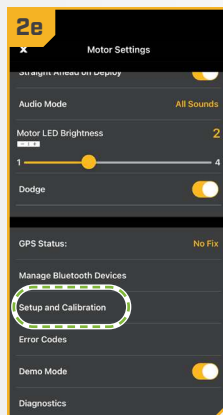

# ONE-BOAT NETWORK BUTTONS



## ONE-BOAT NETWORK BUTTONS >

Minn Kota trolling motors equipped with Advanced GPS Navigation are compatible with devices enabled with the One-Boat Network (OBN), such as the Wireless Remote. OBN functions can be enabled and disabled through four customizable OBN buttons on the Wireless Remote. The function of the OBN buttons can be customized based on user preference to enhance operation of the OBN product.



## CUSTOMIZING THE ONE-BOAT NETWORK BUTTONS ON THE WIRELESS REMOTE

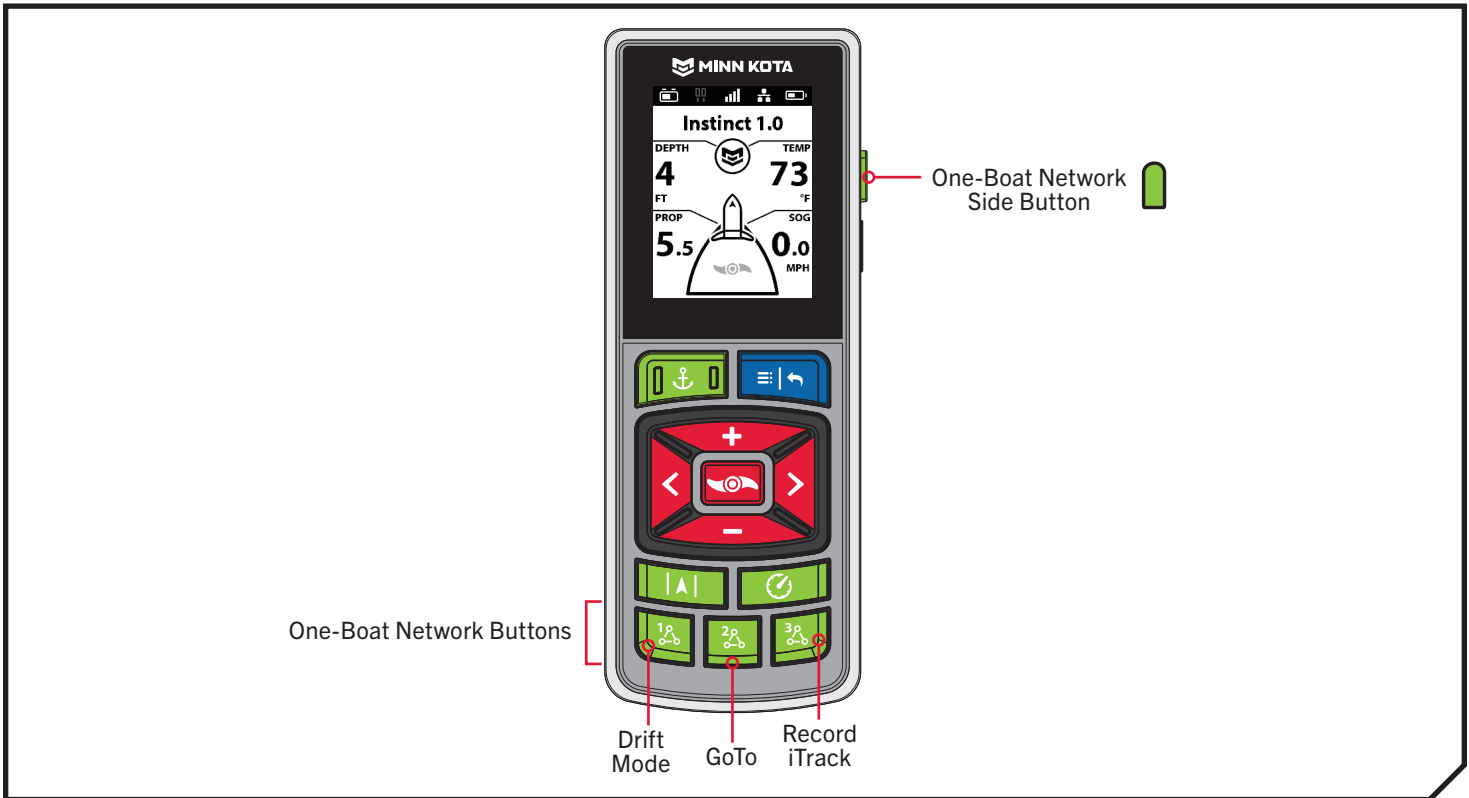







One-Boat Network Default Buttons			
	Drift Mode		Record iTrack
	GoTo		Deployment Mode



# CUSTOMIZING THE ONE-BOAT NETWORK BUTTONS ON THE WIRELESS REMOTE













One-Boat Network functions can be enabled and disabled through four One-Boat Network buttons on the Wireless Remote. The One-Boat Network buttons can be customized to control the following functions, depending on your setup:

Function	Icon	Description
Drift Mode		Drift mode is the default function for OBN Button 1. Press once to engage Drift Mode. Press a second time to Adjust Course.
Go To		Go To is the default for the OBN Button 2. Press once to open the Go To Menu. The Go To options are Spot-Locks, Waypoints, iTracks and Drift.
Record iTrack		Record iTrack is the default function for OBN Button 3. Press once to start recording an iTrack. Press a second time to save the iTrack.
Waypoint		Mark Waypoint must first be customized to one of the OBN buttons. Press once to save a Waypoint.
Max Speed		Max Speed must first be customized to one of the OBN buttons. Double press to engage Max Speed. Single press to return to the previous speed.
Talon/Raptor		The shallow water anchor function must first be customized to one of the OBN buttons. The shallow water anchor function will display as Talon or Raptor depending on your configuration. Double press to deploy the anchor. Press once to pause or stow the anchor.
Deployment Mode		Deployment Mode is the default function for the OBN Side Button on trolling motors with a stow/deploy and trim function. The Deployment Mode function will display as Instinct. Press the OBN Side Button once to bring up the Instinct menu.

# CUSTOMIZING THE ONE-BOAT NETWORK BUTTONS ON THE WIRELESS REMOTE





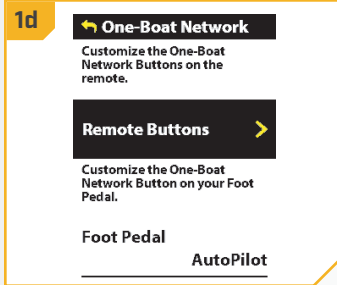
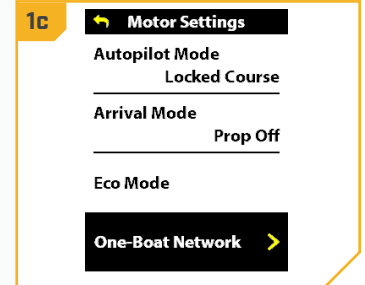
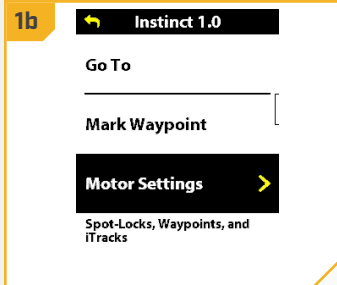

## › Customize the One-Boat Network Buttons on the Wireless Remote

1

- On the Wireless Remote, press the Menu  button to open the Motor Menu.
- In the Motor Menu, use the Speed Down  or Speed Up  button to find the Motor Settings menu. Use the Steer Right  button to select Motor Settings.
- In the Motor Settings menu, use the Speed Down  or Speed Up  button to find One-Boat Network. Use the Steer Right  button to select One-Boat Network.
- In the One-Boat Network Menu, use the Speed Down  or Speed Up  button to find Remote Buttons. Use the Steer Right  button to select Remote Buttons.



2

- Use the Speed Down  or Speed Up  button to highlight the OBN button to customize. There are four options: Button 1, Button 2, Button 3 or Side Button. Press the Steer Right  button to make the selection.
- Use the Speed Down  or Speed Up  button to scroll through the options. Use the Steer Right  button to select the function.

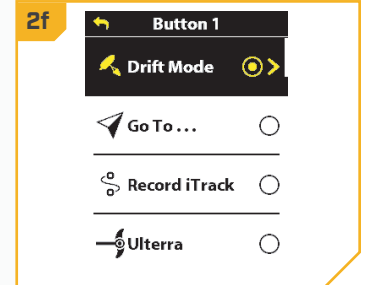
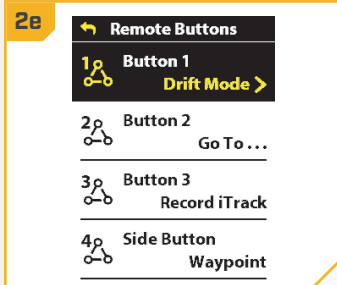

**NOTICE:** The radio button next to the desired function will be selected when the Steer Right  button is used to customize the function. The function options listed are based on the trolling motor and other devices in the Advanced GPS Navigation network.

**NOTICE:** For quick customization, press and hold the OBN button you want to customize to quickly bring up the customization screen.

- Press and hold the Menu  button to close and return to the Home Screen.

# QUICK STOW & DEPLOY

## STOWING AND DEPLOYING THE RIPTIDE INSTINCT QUEST





The Riptide Instinct™ QUEST™ gives you push-button command from anywhere on the boat. Stow, deploy or trim the motor up and down by using the buttons on your Advanced GPS Navigation Wireless Remote, Foot Pedal, One-Boat Network app, or a connected Humminbird® fish finder. It's instant. Effortless. And it makes Riptide Instinct QUEST the easiest-to-use motor on the water.



Use the following procedures to stow and deploy the motor. If the motor stalls when attempting to stow, the motor may be encountering an error. Check for obstructions or low motor batteries. If the batteries are too low to fully stow the motor, re-engage power, deploy the motor, trim the lower unit to its highest setting, and turn power off until batteries can be recharged. Once batteries are charged, attempt to stow the motor again.

### STOW & DEPLOY >

## STOWING AND DEPLOYING WITH THE WIRELESS REMOTE

### > Deploying with the Wireless Remote

- 1
  - a. Press the Power  button on the Wireless Remote.
  - b. Use the Speed Up  or Speed Down  button to find Instinct.
  - c. Press the Steer Right  button to select Instinct and open Deployment Mode.

**NOTICE:** Alternatively, press the One-Boat Network  side button to quickly access Deployment Mode. The function of the OBN  side button is set by default to open the Instinct Deployment Mode menu.

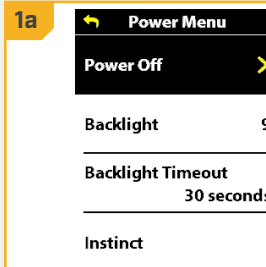

**NOTICE:** The Wireless Remote comes from the factory paired to the Riptide Instinct QUEST.

# STOWING WITH THE WIRELESS REMOTE

2

- d. Press the Steer Right button to select Deploy. The motor will automatically deploy.

**WARNING**

As soon as Deploy is selected, the motor will automatically deploy. Be sure that the motor is clear from obstructions and has a clear path of travel. The Prop is disabled while the motor is stowing or deploying to prevent accidental contact with the rotating Prop.

- e. While the Motor is deploying, it is possible to pause the action. To pause the action, press the Steer Right button to select Pause.
- f. To resume the Deploy action, press the Steer Right button to select Deploy.
- g. If the Motor continues, it will complete the deploy process and normal motor operation will follow.

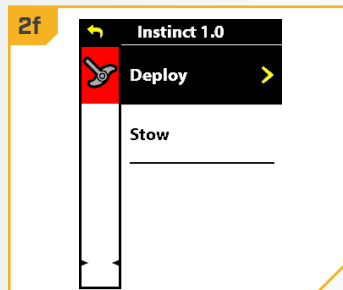
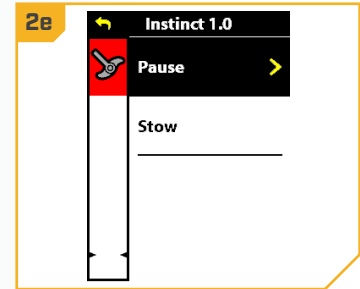
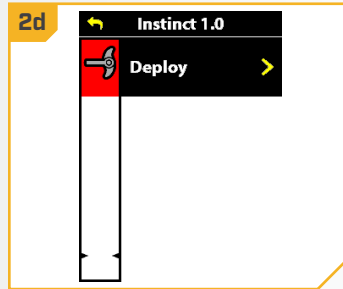

**NOTICE:** To avoid churning or agitation of surface water, ensure that the top of the motor is submerged at least 12" below the surface of the water.

## Stowing with the Wireless Remote

1

- a. Press the Power button on the Wireless Remote.
- b. Use the Speed Up or Speed Down button to find Instinct.
- c. Press the Steer Right button to select Instinct and open Deployment Mode.

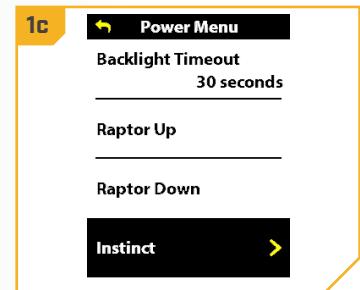
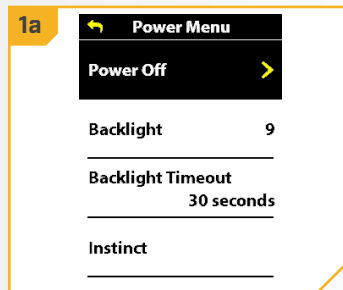

**NOTICE:** Alternatively, press the One-Boat Network side button to quickly access Deployment Mode. The function of the OBN side button is set by default to open the Instinct Deployment Mode menu.







# STOWING WITH THE WIRELESS REMOTE

2

- d. Use the Speed Up  or Speed Down  button to find Stow. Use the Steer Right  button to select it. Once selected, the motor will automatically stow, and the Prop will be disabled.

## WARNING

As soon as Stow is selected, the motor will automatically stow. Be sure the motor is clear from obstructions and has a clear path of travel. The Prop is disabled while the motor is stowing or deploying to prevent accidental contact with the rotating Prop.

- e. While the Motor is stowing, it is possible to pause the action. To pause the action, press the Speed Down  button to find Pause and press the Steer Right  button to select it.
- f. To resume the Stow action, press the Steer Right  button to select Stow.
- g. If the Motor continues, it will complete the Stow process and normal motor operation will follow.

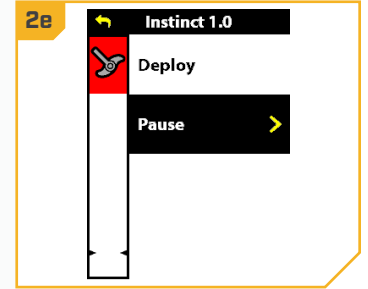
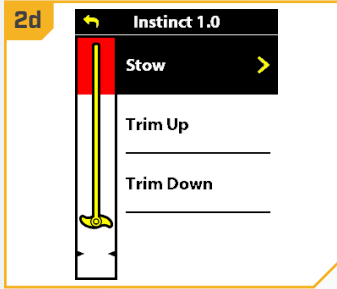

**NOTICE:** The Stow option is only displayed when the motor is deployed.

## WARNING

The motor is not safely stowed for transport until the orange STOWED  LED on the Indicator Panel is illuminated.

# DEPLOYING WITH THE OBN APP

## STOWING AND DEPLOYING WITH THE ONE-BOAT NETWORK (OBN) APP

### Deploying with the OBN App

1

- a. Open the One-Boat Network (OBN) app on the mobile device. Make sure the mobile device is paired with the trolling motor.
- b. From the OBN home screen, tap the Motor menu. The Motor menu opens the Motor home screen.
- c. Before the Motor home screen will open, tap Agree on the on-screen prompt.

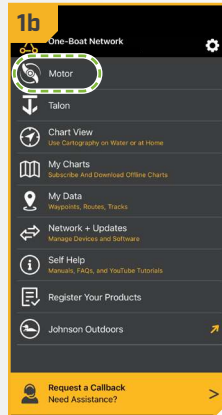

**NOTICE:** The on-screen prompt will only display once each time the app is launched. If the prompt has displayed, the Motor home screen appears after.

2

- d. Tap Trim/Stow on the bottom of the screen to open the Trim/Stow/Deploy menu.
- e. Tap Deploy to automatically deploy the motor. Normal motor operation will follow.

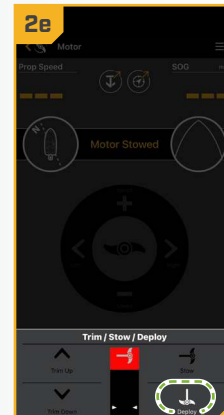
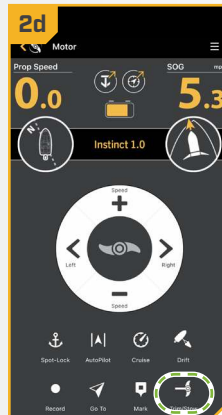

### WARNING

As soon as Deploy is tapped, the motor will automatically deploy. Be sure that the motor is clear from obstructions and has a clear path of travel. The Prop is disabled while the motor is stowing or deploying to prevent accidental contact with the rotating Prop.

**NOTICE:** While the motor is deploying, it is possible to stop the action by tapping Pause. To resume, tap the desired action.

**NOTICE:** To avoid churning or agitation of surface water, ensure that the top of the motor is submerged at least 12" below the surface of the water.

## › Stowing with the OBN App

1

- a. Open the One-Boat Network (OBN) app on the mobile device. Make sure the mobile device is paired with the trolling motor.
- b. From the OBN home screen, tap the Motor menu. The Motor menu opens the Motor home screen.
- c. Before the Motor home screen will open, tap Agree on the on-screen prompt.

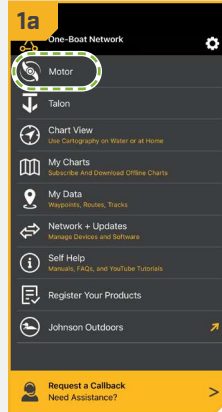

**NOTICE:** The on-screen prompt will only display once each time the app is launched. If the prompt has displayed, the Motor home screen appears after.

2

- d. Tap Trim/Stow on the bottom of the screen to open the Trim/Stow/Deploy menu.
- e. Tap Stow to automatically stow the motor. The Prop will be disabled and "Motor Stowed" will display on the screen.

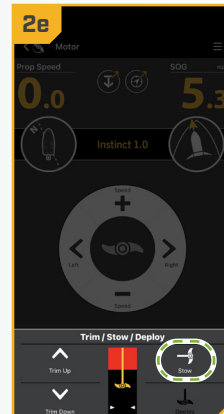

### WARNING

As soon as Stow is tapped, the motor will automatically stow. Be sure the motor is clear from obstructions and has a clear path of travel. The Prop is disabled while the motor is stowing or deploying to prevent accidental contact with the rotating Prop.

**NOTICE:** While the motor is stowing, it is possible to stop the action by tapping Pause. To resume, tap the desired action.

### WARNING

The motor is not safely stowed for transport until the orange STOWED LED on the Indicator Panel is illuminated.

# ADJUSTING THE DEPTH (TRIM) OF THE RIPTIDE INSTINCT QUEST





## ADJUSTING THE DEPTH (TRIM) OF THE RIPTIDE INSTINCT QUEST

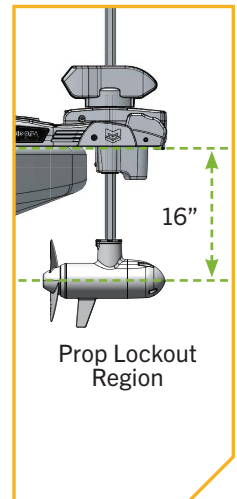
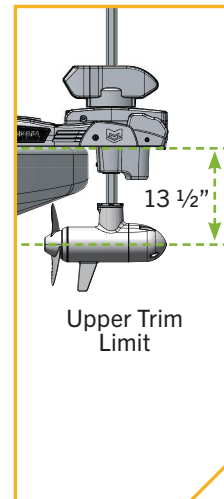
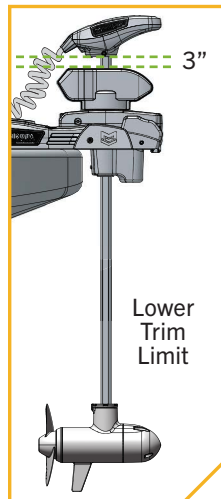
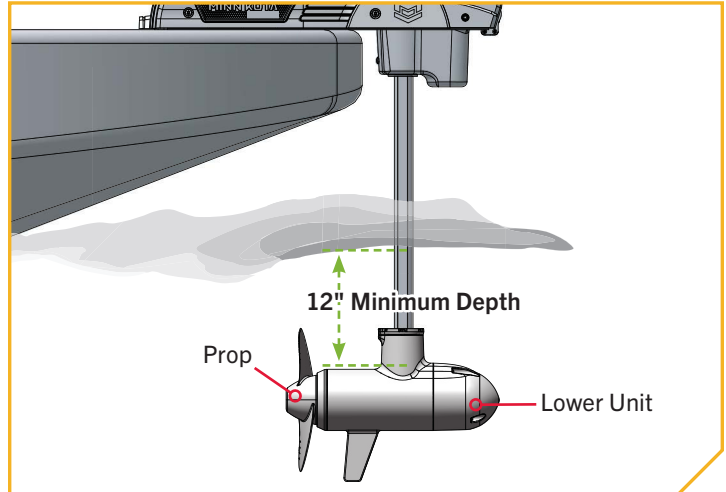

Once the boat is on the water, it may be necessary to adjust the trim of the Lower Unit up or down to achieve an optimum depth for motor performance. When setting the depth of the motor, be sure the top of the Lower Unit is submerged at least 12" below the surface of the water to avoid churning or agitation of surface water. It may be necessary to trim the motor up or down, depending on how the boat is responding. Trim up to avoid hitting underwater objects and trim down if the Prop is coming out of the water.

The Prop will temporarily stop while trimming the motor and resume once trimming is stopped. The motor is programmed to operate safely and limit Prop rotation when the Lower Unit is trimmed within certain limits. Trim limits are in place to avoid damage to the unit. A Lower Trim Limit is set approximately 3" from the bottom of the Control Head to the top of the Trim Housing. An Upper Trim Limit is set 13 1/2" from the bottom of the Mount to the center of the Lower Unit. A Prop Lockout Region, defined as 16" from the bottom of the Mount to the center of the Lower Unit, is used to eliminate the possibility of the motor contacting the boat hull. All functions, except for manual steering and recording an iTrack, are canceled upon trimming into this region.



## ▶ Trimming with the Wireless Remote

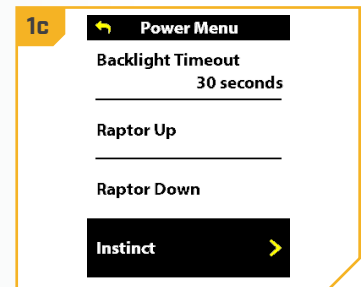
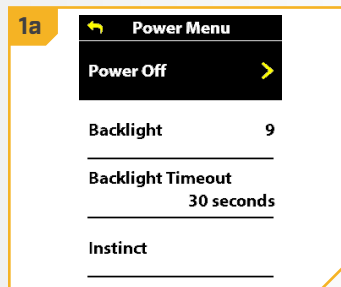

- 1 a. Press the Power  button on the Wireless Remote.
- b. Use the Speed Up  or Speed Down  button to find Instinct.
- c. Press the Steer Right  button to select Instinct and open Deployment Mode.

**NOTICE:** Alternatively, press the One-Boat Network  side button to quickly access Deployment Mode. The function of the OBN  side button is set by default to open the Instinct Deployment Mode menu.



# TRIMMING WITH THE WIRELESS REMOTE

2

- d. Once in Instinct Menu, use the Speed Up  or Speed Down  button to select Trim Up or Trim Down. Trimming up will raise the motor and trimming down will lower the motor.
- e. Press and hold the Steer Right  button to select it.
- f. When the motor has reached its highest trim limit, the Prop will be locked out and the Trim Up option will be disabled. The Prop will stay locked out even when the Deployment Menu has closed. Trim the motor down and out of the Prop Lockout region to restore functionality.
- g. When the lower trim limit is reached, the Trim Down option will be disabled.

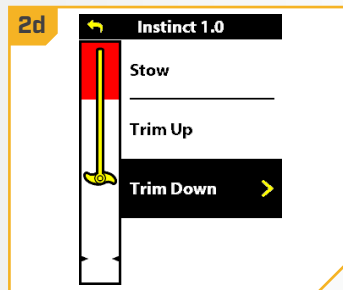
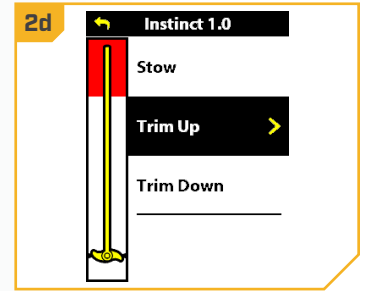
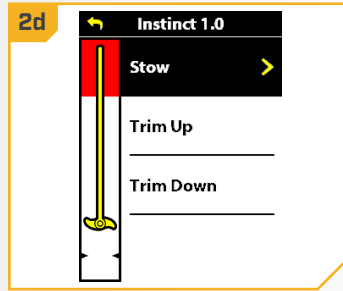

 **WARNING**

While Trim Up or Trim Down is pressed, the motor will automatically trim. Be sure the motor is clear from obstructions and has a clear path of travel. The Prop is disabled while the motor is being trimmed to prevent accidental contact with the rotating Prop.

 **WARNING**

When trimming the motor, keep fingers clear of all hinges, pivot points and all moving parts.

**NOTICE:** To avoid churning or agitation of surface water, ensure that the top of the motor is submerged at least 12" below the surface of the water.

**NOTICE:** The red area is the Prop Lockout region. The Prop will be automatically disabled if the lower unit is trimmed into this zone, and the Prop icon will turn gray. To restore Prop functionality, trim the lower unit out of the Prop Lockout region.

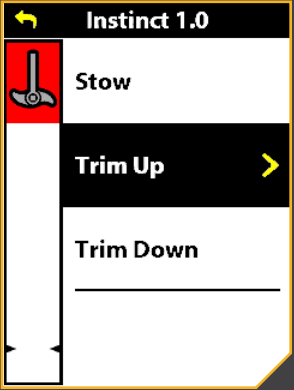

A screenshot of the Instinct 1.0 menu. The top bar shows a back arrow and 'Instinct 1.0'. Below it is a vertical slider with a red area at the top and a gray prop icon at the bottom. The menu options are 'Stow', 'Trim Up', and 'Trim Down'. 'Trim Up' is highlighted with a yellow arrow pointing right.

# TRIMMING WITH THE OBN APP

## ▶ Trimming with the OBN App

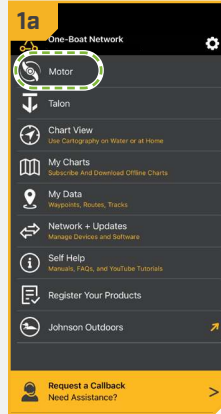

1

- Open the One-Boat Network (OBN) app on the mobile device. Make sure the mobile device is paired with the trolling motor.
- From the OBN home screen, tap the Motor menu. The Motor menu opens the Motor home screen.
- Before the Motor home screen will open, tap Agree on the on-screen prompt.



**NOTICE:** The on-screen prompt will only display once each time the app is launched. If the prompt has displayed, the Motor home screen appears after.

2

- Tap Trim/Stow on the bottom of the screen to open the Trim/Stow/Deploy menu.
- To trim the motor up, press and hold Trim Up . Continue to hold until the lower unit is at the desired height.
- To trim the motor down, press and hold Trim Down . Continue to hold until the lower unit is at the desired height.

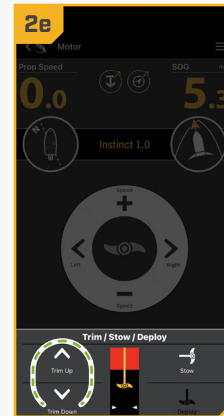

### WARNING

While Trim Up or Trim Down is pressed, the motor will automatically trim. Be sure the motor is clear from obstructions and has a clear path of travel. The Prop is disabled while the motor is being trimmed to prevent accidental contact with the rotating Prop.

### WARNING

When trimming the motor, keep fingers clear of all hinges, pivot points and all moving parts.

**NOTICE:** The red area is the Prop Lockout region. The Prop will be automatically disabled if the lower unit is trimmed into this zone, and the Prop icon will turn gray. To restore Prop functionality, trim the lower unit out of the Prop Lockout region.



**NOTICE:** To avoid churning or agitation of surface water, ensure that the top of the motor is submerged at least 12" below the surface of the water.

This completes the installation of your Riptide Instinct QUEST. A complete Owner's Manual can be downloaded at [minnkota.johnsonoutdoors.com](http://minnkota.johnsonoutdoors.com).

# NOTES



A large area for taking notes, consisting of 25 horizontal lines spaced evenly down the page.

# RECOMMENDED ACCESSORIES

## › ON-BOARD & PORTABLE BATTERY CHARGERS

Stop buying new batteries and start taking care of the ones you've got. Many chargers can actually damage your battery over time – creating shorter run times and shorter overall life. Digitally controlled Minn Kota chargers are designed to provide the fastest charge that protect and extend battery life.



MK212PCL



MK210D



MK110PD

## › TALON SHALLOW WATER ANCHOR

Talon is the only shallow water anchor with up to 15' of anchoring depth, multiple anchoring modes, and control from the bow, transom, console, remote or mobile device.



### BUILT-IN WORK LIGHT

Lets you tie lines and work from the transom any time of day — or night. Includes both white and blue LED lights with three brightness settings.



### BLUETOOTH® CONNECTIVITY

Lets you control Talon from your mobile device and easily update it. Also opens up communication to other control options.



### UP TO 15' DEEP

Control more water and catch more fish with the first 15' shallow water anchor.



### MORE CONTROL OPTIONS

- Control Panel
- Wireless Remote
- Mobile App
- Wireless Foot Switch
- Humminbird® Connectivity
- Advanced GPS Navigation System Remote



## › MINN KOTA ACCESSORIES

We offer a wide variety of trolling motor accessories, including:

- 60-Amp Circuit Breaker
- Mounting Brackets
- Stabilizer Kits
- Boat Deck Reinforcement Kit
- Battery Connectors
- Battery Boxes
- Quick Connect Plugs



minnkota.johnsonoutdoors.com    

Part #2207128

Minn Kota Consumer & Technical Service  
Johnson Outdoors Marine Electronics, Inc.  
PO Box 8129  
Mankato, MN 56001

ECN 44313

121 Power Drive  
Mankato, MN 56001  
Phone (800) 227-6433  
Fax (800) 527-4464



©2023 Johnson Outdoors Marine Electronics, Inc.  
All rights reserved.

Rev B

10/23