

PARTS DIAGRAM

PONTOON HC 70

70 LBS THRUST - 24 VOLT - 52" SHAFT

This page provides Minn Kota® WEEE compliance disassembly instructions. For more information about where you should dispose of your waste equipment for recycling and recovery and/or your European Union member state requirements, please contact your dealer or distributor from which your product was purchased.

Tools required, but not limited to: flat head screw driver, Phillips screw driver, socket set, pliers, wire cutters.

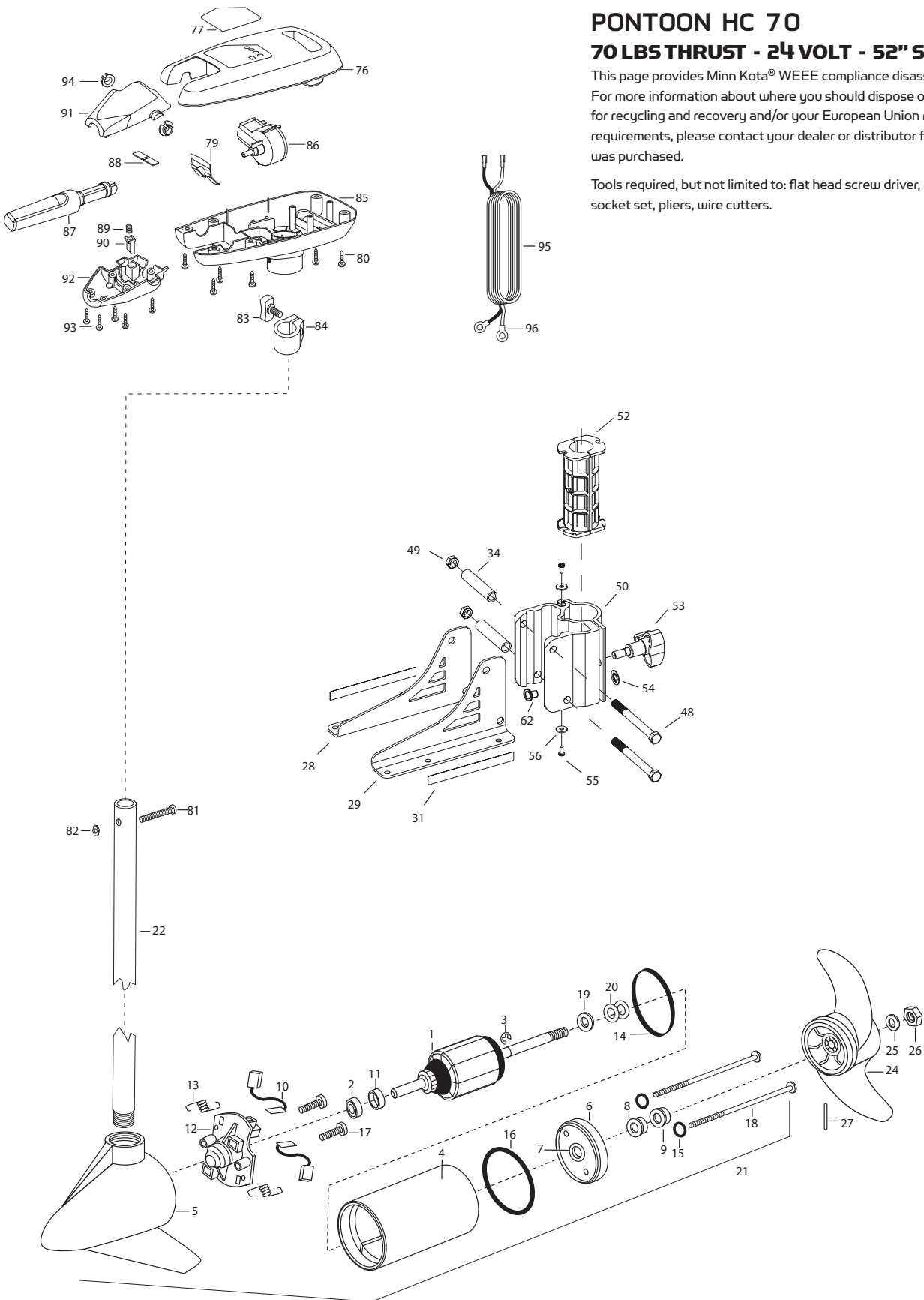

PARTS LIST

PONTOON HC 70

70 LBS THRUST - 24 VOLT - 52" SHAFT

ITEM	QTY	PART NUMBER	DESCRIPTION
1	1	2-100-119	ARMATURE ASSEMBLY 12 V 3.625
2	1	140-010	BALL BEARING
3	1	788-015	RETAINING RING
4	1	2-200-005	CENTER HOUSING ASSEMBLY
5	1	2-300-139	BRUSH END HOUSING ASSEMBLY SPDCO
6	1	2-400-101	PLAIN END HOUSING ASSEMBLY
7	1	144-049	BEARING – FLANGE (SERVICE ONLY)
8	1	880-003	SEAL
9	1	800-006	SEAL W/SHIELD
10	2	188-037	BRUSH ASSEMBLY
11	1	725-035	TUBE – BRUSH RETENTION
12	1	738-036	BRUSH PLATE WITH HOLDER
13	2	975-040	TORSION SPRING
14	1	337-036	GASKET
15	2	701-008	O-RING THRU BOLT
16	1	701-081	O-RING
17	2	830-007	#8-32 SCREW
18	2	830-008	THRU BOLT 10-32X8.83
19	1	990-067	WASHER – STEEL THRUST
20	2	990-070	WASHER – NYLATRON
21	1	2096039	MOTOR ASSEMBLY 24V F/W 3.625 55PCO
22	1	2032068	TUBE – COMPOSITE-52"
■	1	1378131	PROPELLER KIT
*24	1	2061160	PROPELLER – W/WEDGE 2
*25	1	2151726	WASHER – 5/16 SS
*26	1	2053101	NUT – PROP NYLOC
*27	1	2092600	PIN – DRIVE
■	1	2991715	PONTOON BRACKET ASSEMBLY
28	1	2261915	LEFT BRACKET
29	1	2261916	RIGHT BRACKET
31	2	2265689	DECAL, MINNKOTA
34	2	2261727	BRACKET SPACER
48	1	2263511	BOLT 3/8-16 X 4.0"
49	1	2263114	NUT – NYLOCK JAM 3/8-16
50	1	2991829	HINGE-DOOR-KNOB-ASSEMBLY
52	2	2261537	HINGE SLEEVE
53	1	2260905	HANDLE – SOFT GRIP, L&D
54	1	2261728	WASHER – RETAINING 3/8"
55	2	2053415	SCREW #8-32 X 3/8" TRI
56	2	2261732	WASHER #8, NYLON
62	1	2264703	INSERT – THREADED
76	1	2060285	COVER – CONTROL BOX
77	1	2275618	DECAL – COVER EDGE 55/H
79	1	2302743	SPRING – DETENT HANDLE-TILT

ITEM	QTY	PART NUMBER	DESCRIPTION
80	6	2303412	SCREW – 6-20 X 5/8 SELF TAP
81	1	2033400	SCREW – 10-24 X 1-3/4
82	1	2013110	NUT – 10-24 HEX (ZCP)
83	1	2011365	SCREW – COLLAR/NEW KNOB
84	1	2031520	COLLAR – DEPTH W/O INSERT
85	1	2062551	CONTROL BOX PLAS W/HAND
86	1	2064028	SWITCH – FWD/REV 5SP
87	1	2990912	HANDLE ASSEMBLY-W/U-JOINT 5SP
88	1	2302742	SPRING – DETENT OFF
89	1	2302745	SPRING – RELEASE BUTTON
90	1	2303720	RELEASE BUTTON – HANDLE
91	1	2060408	HANDLE – TOP HALF
92	1	2060415	HANDLE – LOWER HALF
93	5	2303412	SCREW – 6-20 X 5/8 SELF TAP
94	2	2060005	BEARING – HANDLE PIVOT
95	1	2090650	LEADWIRE – 10 GA RINGS
96	2	2020700	TERMINAL RING, 3/8"
■	1	2994838	BAG ASSEMBLY – BOLTS NUTS WASHERS
*98	6	2263462	SCREW 1/4-20X2 SS
*99	6	2261713	WASHER – 1/4 FLAT 18-18
*100	6	2263101	NUT – 1/4-20 NYLOC-JAM
■	1	2888460	SEAL & O-RING KIT

■ THIS ITEM IS PART OF AN ASSEMBLY.

*THIS ITEM IS PART OF A KIT AND ONLY LISTED FOR VIEWING PURPOSES.