

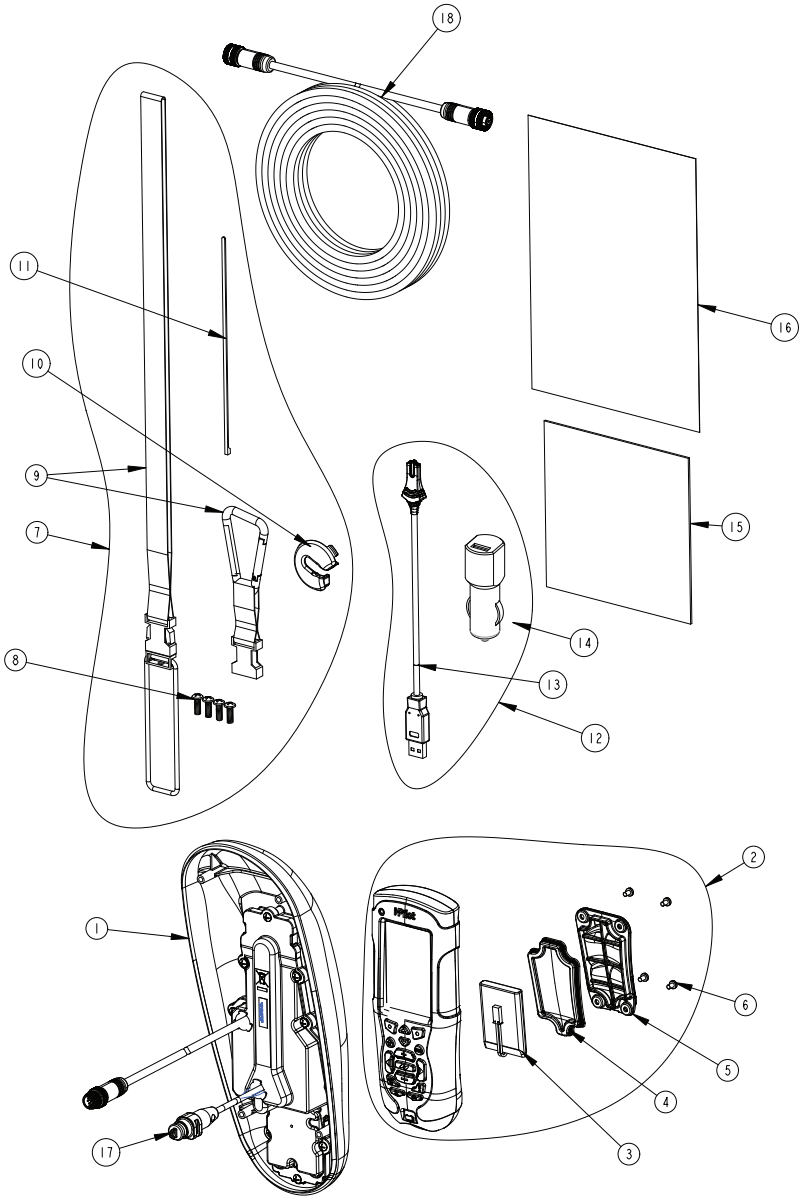

i-Pilot[®] LINK

INSTALLATION GUIDE

PARTS LIST VIEW TERROVA & RIPTIDE ST



INSTALLATION GUIDE

ITEM #	PART NUMBER	DESCRIPTION	QTY
TERROVA			
1	2990280	HEAD ASSY,TERROVA, IP2	1
2	2994180	REMOTE ASSY, i-PILOT LINK	1
3	2370712	BATTERY, LIPO PACK	1
4	2374637	O-RING, BATTERY SEAL	1
5	2376421	DOOR, BATTERY	1
6	2383442	SCREW-3MM X .5 PPH MACHINE	4
7	2994907	BAG ASSY, i-PILOT LINK,TRRV	1
8	2372100	SCREW-#8-18 X 5/8 THD* (SS	4
9	2370817	LANYARD,RMT w/CARABINER	1
10	2224704	INSERT-PLUG, BLK, i-PILOT LINK	1
11	2376312	TIE WRAP,BLACK,UV RESIST.NYLON	5
12	2994909	BAG ASSY, i-PILOT LINK, POWER	1
13	2373241	CABLE, USB REMOTE CHARGER	1
14	2375901	ADAPTER, USB DC POWER	1
15	2377156	MANUAL-CD, i-PILOT LINK	1
16	2377155	MANUAL QCK REF, i-PILOT LINK	1
17	2320203	CAP-DUST,CONNECTOR,FEMALE	1
18	490389-1	CABLE, ETH (M12-M-M12-F, 30'	1
RIPTIDE ST			
1	2990281	HEAD ASSY, ST, IP2	1
2	2994180	REMOTE ASSY, i-PILOT LINK	1
3	2370712	BATTERY, LIPO PACK	1
4	2374637	O-RING, BATTERY SEAL	1
5	2376421	DOOR, BATTERY	1
6	2383442	SCREW-3MM X .5 PPH MACHINE	4
7	2994907	BAG ASSY, i-PILOT LINK, TRRV	1
8	2372100	SCREW-#8-18 X 5/8 THD* (SS	4
9	2370817	LANYARD,RMT w/CARABINER	1
10	2224704	INSERT-PLUG, BLK, i-PILOT LINK	1
11	2376312	TIE WRAP,BLACK,UV RESIST.NYLON	5
12	2994909	BAG ASSY, i-PILOT LINK, POWER	1
13	2373241	CABLE, USB REMOTE CHARGER	1
14	2375901	ADAPTER, USB DC POWER	1
15	2377156	MANUAL-CD, i-PILOT LINK	1
16	2377155	MANUAL QCK REF, i-PILOT LINK	1
17	2320203	CAP-DUST,CONNECTOR,FEMALE	1
18	490389-1	CABLE, ETH (M12-M-M12-F, 30'	1

PARTS LIST VIEW POWERDRIVE V2 & RIPTIDE SP

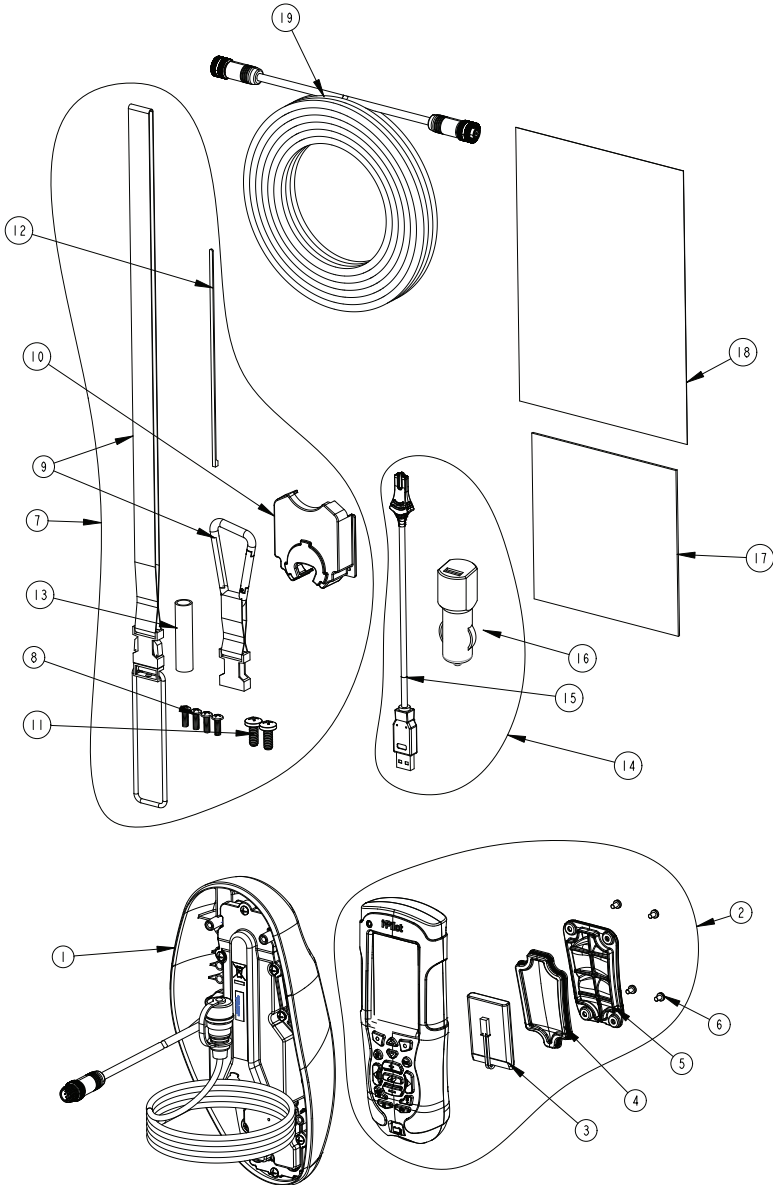

INSTALLATION GUIDE

ITEM #	PART NUMBER	DESCRIPTION	QTY
POWERDRIVE V2			
1	2990282	HEAD ASSY,V2, IP2	1
2	2994180	REMOTE ASSY, i-PILOT LINK	1
3	2370712	BATTERY, LIPO PACK	1
4	2374637	O-RING, BATTERY SEAL	1
5	2376421	DOOR, BATTERY	1
6	2383442	SCREW-3MM X .5 PPH MACHINE	4
7	2994908	BAG ASSY, i-PILOT LINK,V2	1
8	2372100	SCREW-#8-18 X 5/8 THD* (SS	4
9	2370817	LANYARD,RMT w/CARABINER	1
10	2376716	PLUG, STRAIN RELIEF V2/SP	1
11	2332104	SCREW-1/4-20 X 5/8 S/S	2
12	2376312	TIE WRAP,BLACK,UV RESIST.NYLON	5
13	2375403	HEATSHRK .375X2 ADHV LINED	4
14	2994909	BAG ASSY, i-PILOT LINK, POWER	1
15	2373241	CABLE, USB REMOTE CHARGER	1
16	2375901	ADAPTER, USB DC POWER	1
17	2377156	MANUAL-CD, i-PILOT LINK	1
18	2377155	MANUAL QCK REF, i-PILOT LINK	1
19	490389-1	CABLE, ETH (M12-M-M12-F, 30'	1
RIPTIDE SP			
1	2990283	HEAD ASSY, SP, IP2	1
2	2994180	REMOTE ASSY, i-PILOT LINK	1
3	2370712	BATTERY, LIPO PACK	1
4	2374637	O-RING, BATTERY SEAL	1
5	2376421	DOOR, BATTERY	1
6	2383442	SCREW-3MM X .5 PPH MACHINE	4
7	2994908	BAG ASSY, i-PILOT LINK,V2	1
8	2372100	SCREW-#8-18 X 5/8 THD* (SS	4
9	2370817	LANYARD,RMT w/CARABINER	1
10	2376716	PLUG, STRAIN RELIEF V2/SP	1
11	2332104	SCREW-1/4-20 X 5/8 S/S	2
12	2376312	TIE WRAP,BLACK,UV RESIST.NYLON	5
13	2375403	HEATSHRK .375X2 ADHV LINED	4
14	2994909	BAG ASSY, i-PILOT LINK,POWER	1
15	2373241	CABLE, USB REMOTE CHARGER	1
16	2375901	ADAPTER, USB DC POWER	1
17	2377156	MANUAL-CD, i-PILOT LINK	1
18	2377155	MANUAL QCK REF, i-PILOT LINK	1
19	490389-1	CABLE, ETH (M12-M-M12-F, 30'	1

The i-Pilot installation will require permanently removing the motor control box cover. This cover includes information about your motor that may be needed for future service work or when ordering replacement parts. Please note the information from your motor in the space provided below.

Motor model (circle one) Terrova, Riptide ST, PowerDrive V2 or Riptide SP
Auto Pilot (Yes or No) _____
Motor thrust (55lb, 70lb, etc) _____

PREPARING FOR INSTALLATION

Preparing for Installation

Tools you will need during installation

Terrova and Riptide ST

-Phillips screwdriver

PowerDrive V2

-Phillips screwdriver

-Needle-nose pliers

-Utility knife

-Heat gun or other heat source for installing heat shrink

Riptide SP

-Phillips screwdriver

-Needle-nose pliers

-Utility knife

-Heat gun or other heat source for installing heat shrink

To help with future service work or ordering replacement parts, please refer to the information box in the Notes section located on the back pages of this manual.

Before installing i-Pilot Link on your motor, make sure the trolling motor is properly installed on your boat. Find a clean and dry location for performing the installation.

Most importantly, disconnect all power to the trolling motor before installation. Not only will this protect you but also the sensitive electronics you are about to install.

Read through the entire installation process before performing the installation.

If you need help or need further instruction on installing i-Pilot Link, please call Minn Kota technical service at 1-800-227-6433 to talk to a customer service representative.

Humminbird Fishfinder

Depending on your Humminbird model and system configuration, you may need to purchase additional cables, as shown below. Visit our website at humminbird.com or call the Customer Resource Center at **1-800-633-1468**.

- **700 Series with Ethernet:** To connect the Ethernet cable to the control head, you will need to purchase the Ethernet Adapter Cable (AS EC QDE).
- **Extension Cables** are available for the Ethernet Cable if you need to extend the connection longer than the 30 feet provided. See humminbird.com for details.

INSTALLATION OF I-PILOT LINK CONTROLLER

For PowerDrive V2 and Riptide SP trolling motors go to page 12.

i-Pilot Link Installation on Terrova and Riptide ST Trolling Motors

- * *i-Pilot Link will override all **CoPilot** functionality. **CoPilot** remotes will not function with i-Pilot Link.*
- * *The Terrova foot pedal is fully functional and supported when i-Pilot Link is installed correctly.*

1. Disconnect all power to the trolling motor.
2. Remove control box cover screws and cover using Phillips screwdriver. (Figure 1)
3. If the trolling motor has the AutoPilot feature, unplug the AutoPilot control board and remove it from the control box. (Figures 2 and 3)
4. Remove grommet by pulling back on coil cord strain relief and pushing down on grommet. (Figure 4)



FIGURE 1

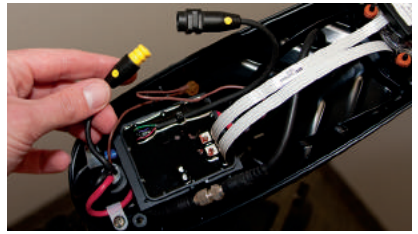

FIGURE 2

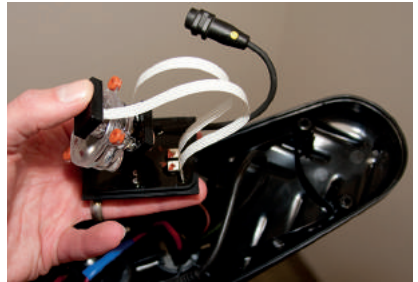

FIGURE 3

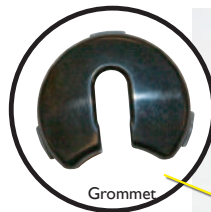

FIGURE 4

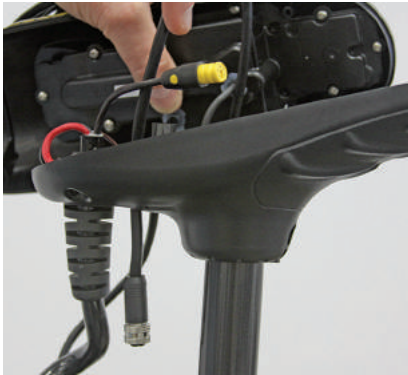

FIGURE 5



FIGURE 6

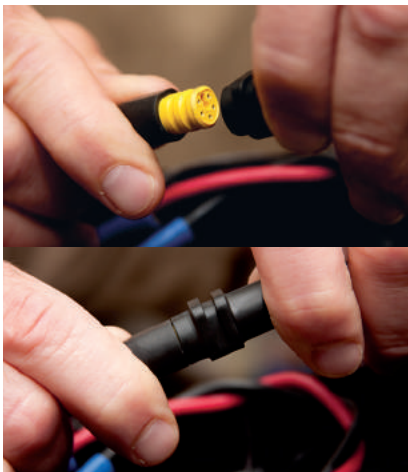

FIGURE 7

5. Route the Ethernet cable through the grommet hole and through the center of the coil cord. (Figure 5)
6. Plug the i-Pilot Link controller connector into the accessory connector as shown. (Figure 6) Be careful to orient connector properly prior to pushing it together. The plug will click twice when pushing it together and the yellow end will be fully covered when installed properly.
 - Make sure connector is aligned properly. (Figure 7)
 - Ensure connector is fully seated as shown. (Figure 7)

INSTALLATION GUIDE

7. Install new grommet supplied with i-Pilot Link by snapping it into the hole located in front of the coil cord strain relief. (Figure 8)
8. Place the i-Pilot Link controller where the control box cover was installed and secure with supplied #8 screws. Do not over tighten screws. (Figure 9)
9. i-Pilot Link is now installed on the motor. Skip ahead to page 22 to verify the installation.



FIGURE 8



FIGURE 9



FIGURE 10



FIGURE 11



FIGURE 12

i-Pilot Link Installation on PowerDrive V2 & Riptide SP

**Note: Once i-Pilot Link is installed in a PowerDrive V2 or Riptide SP motor, the foot pedal cannot be used again unless i-Pilot Link is fully uninstalled.*

1. Disconnect all power to the trolling motor
2. If a **CoPilot** is installed, it must be removed as follows:
 - a. Disconnect motor connector and foot pedal connector from **CoPilot**. (Figure 10)
 - b. Remove the **CoPilot** receiver from the motor by removing both mounting screws. Do not replace these screws as the side plates will be removed in step 13 of this installation. (Figure 11)
3. Remove the control box cover screws and cover using Phillips screwdriver. (Figure 12)

INSTALLATION GUIDE

4. If the trolling motor has **AutoPilot**, it must be removed as follows:
 - a. Disconnect all six **AutoPilot** connectors from **AutoPilot** controller, using a needle-nose pliers and a utility knife to remove any heat shrink insulation that may exist. (Figure 13)
 - b. Remove **the** AutoPilot controller from the head of the trolling motor (Figure 14). This is done by pushing out the locking tabs then lifting the circuit board out. Finally, lift out the compass.
5. Remove grommet by pulling back on coil cord strain relief and pushing down on grommet until it pops out. (Figure 15)

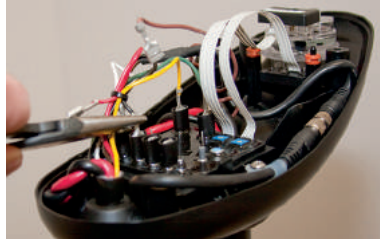

FIGURE 13

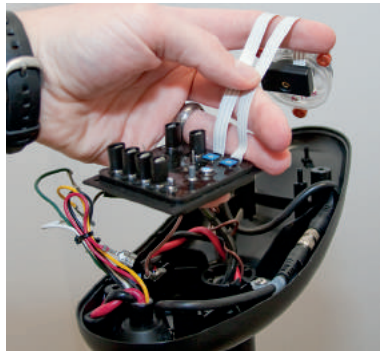

FIGURE 14

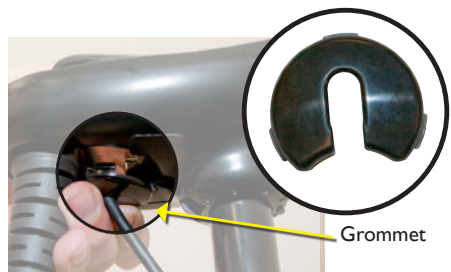

FIGURE 15

Sonar Cable (Universal Sonar Motors Only)

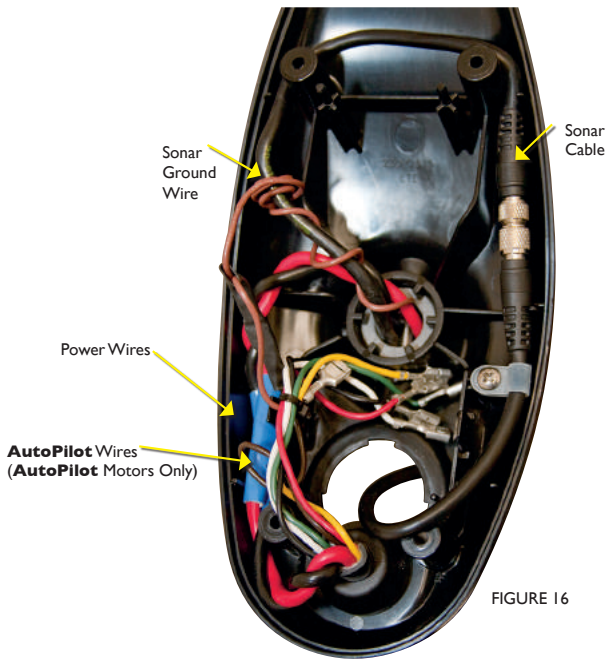

FIGURE 16

6. Review the cables in the head of the trolling motor

- a. If a sonar cable is present, it must be routed around the outer perimeter of the control box. The sonar ground wire should also be routed as shown. (Figure 16)
- b. The motor power wires must be routed as shown. (Figure 16)

7. Route the i-Pilot Link controller cable through the grommet hole and through the center of the coil cord (Figure 17).



FIGURE 17

INSTALLATION GUIDE

8. If **AutoPilot** was removed, insulate the loose AutoPilot connectors as follows:
 - a. For **Powerdrive V2 Motors**: Using a needle-nose pliers push all six **AutoPilot** connectors that were disconnected in step 4 onto terminal holders located on the underside of the i-Pilot Link Controller. (Figure 18)

IMPORTANT: Pull on each wire to make sure it is secured properly. Loose wires can cause damage to i-Pilot Link Controller and the entire motor.

AutoPilot connectors must be placed onto holders exactly as shown. (Figure 19)

- b. For **Riptide SP motors**: Apply heat shrink insulation supplied in bag assembly to the ends of all six loose **AutoPilot** connectors as shown (Figure 20). Use a zip tie to bundle connectors together. Trim the zip tie and place connector bundle in the middle of the control box as shown. (Figure 21)

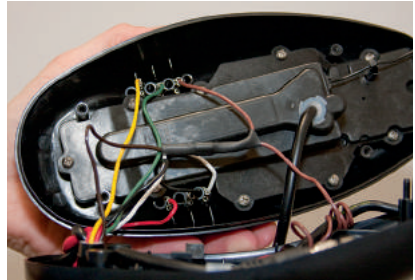

FIGURE 18 Insert **AutoPilot** wires into terminal holders.

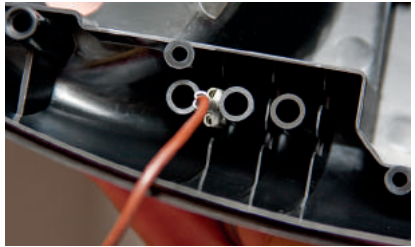

FIGURE 19

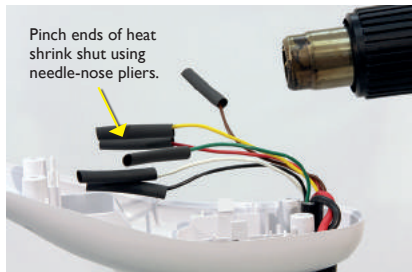

FIGURE 20 Insulate and seal six **AutoPilot** wires on Riptide SP motors with supplied heat shrink.

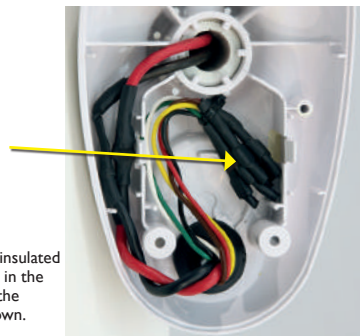

FIGURE 21 Place insulated **AutoPilot** wires in the bottom center of the control box as shown.

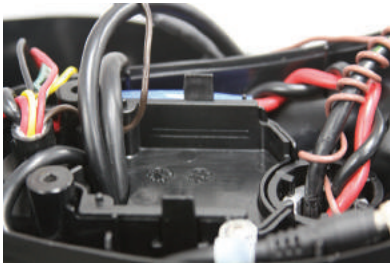

FIGURE 22



FIGURE 23



FIGURE 24



FIGURE 25

9. Install new grommet supplied with i-Pilot Link by snapping it into the hole located in front of the coil cord strain relief. The i-Pilot Link controller cable must be placed in the pass-through slot of the grommet. (Figure 22)
10. Place the i-Pilot Link controller where the control box cover was installed. Pull any extra controller cable out of the control box by gently pulling on the cable. (Figure 23)
11. Secure cover with supplied #8 screws. Do not over tighten screws. (Figure 24)
12. Secure the i-Pilot Link controller cable to the motor coil cord in all three locations shown using zip ties provided. (Figure 25) Trim zip ties using utility knife. Failure to secure cable will result in possible damage to the cabling during operation.
13. Remove the left and right side plates of trolling motor by loosening all four side plate screws using a Phillips screwdriver (Figure 26)



FIGURE 26

INSTALLATION GUIDE

14. Remove center housing by pushing in on both sides and lifting up at the same time. This will expose the main control board and wiring. (Figure 27)
15. The steering motor cable passes through the top of the center housing removed in step 14. This cable contains a black and white wire. Disconnect these two wires by pulling each connector apart. (Figure 28) Riptide SP motors will have these connections covered with heat shrink which must be removed with a utility knife.

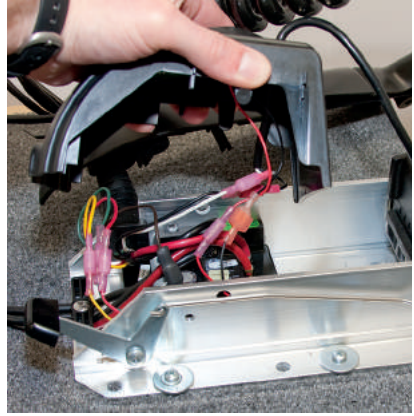
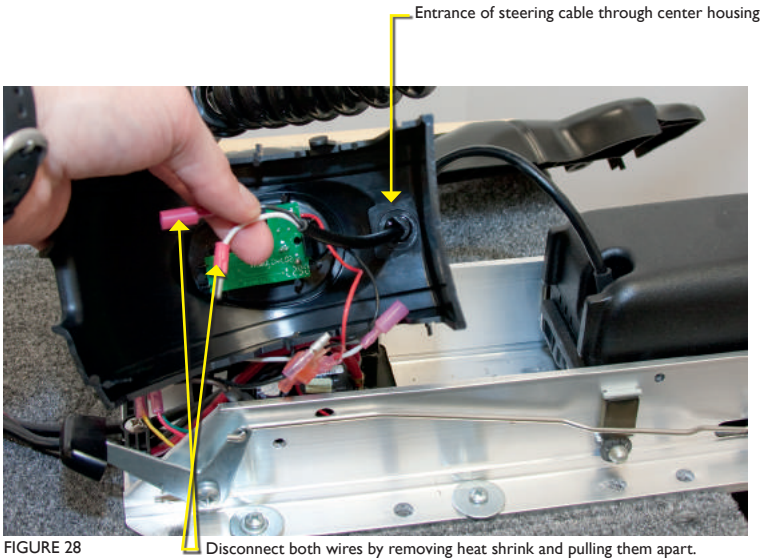

FIGURE 27



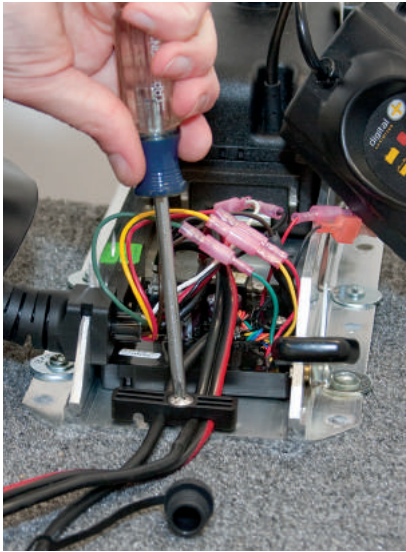

FIGURE 29

16. Loosen the cable strain relief that is secured to the base of the motor and install the i-Pilot Link controller steering cable into the open strain relief slot. (Figure 29)
17. Tighten the cable strain relief as shown. The i-Pilot Link controller steering cable should slide freely through the strain relief when installed properly. (Figures 30 and 31)

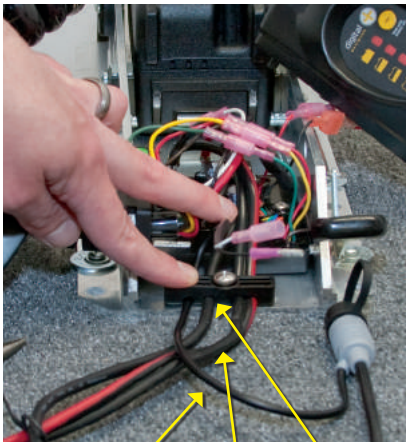

FIGURE 30

i-Pilot Link Controller Steering Cable Motor Power Cable Foot Pedal Cable

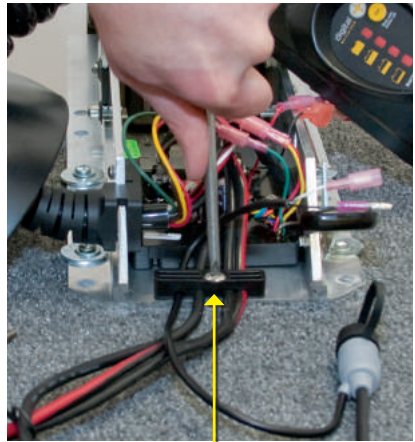

FIGURE 31

Reinstall strain relief screw.

18. Slide four pieces of heat shrink insulation over each side of the wires that were disconnected in step 15. (Figure 32)

Slide heat shrink over steering motor wires.

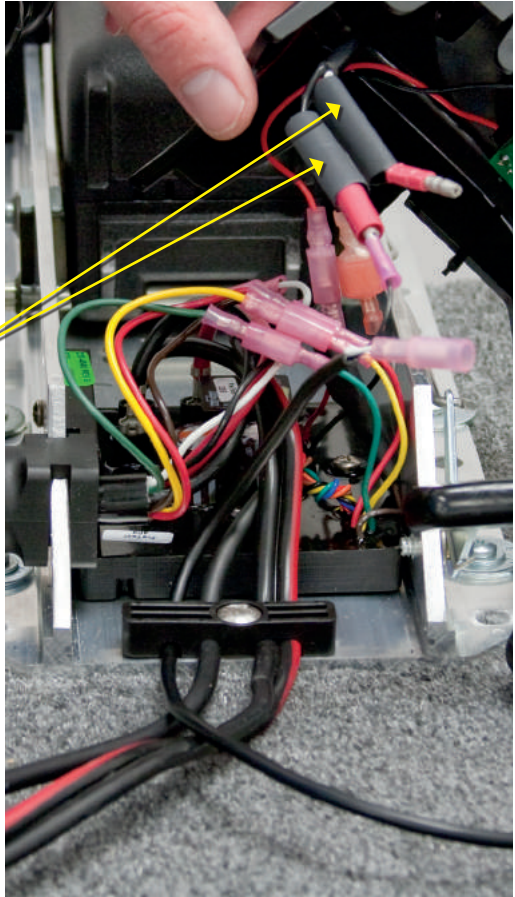
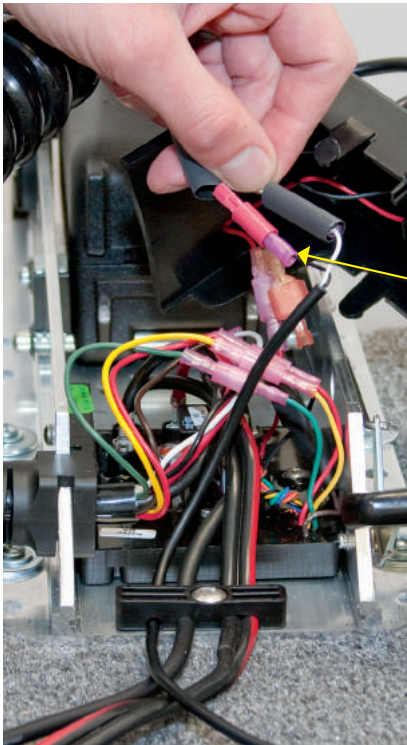

FIGURE 32



Connect steering wires: white to white black to black

19. Connect the black and white wires from the i-Pilot Link controller cable to the black and white steering motor wires, making sure black is connected to black and white is connected to white. (Figure 33)

20. Complete the installation by positioning the heat shrink over the connections and shrink down, using a heat gun or other heat source, being careful not to overheat any wire or parts.

Seal connections with heat shrink.

IMPORTANT: DO NOT OVERHEAT WIRES OR SURROUNDING PARTS WHEN INSTALLING HEAT SHRINK!

21. Reinstall center housing over control board by pushing it down until the side fingers lock into place. The new i-Pilot Link Controller steering cable should be exiting the cable exit hole at the center and bottom of the center housing. (Figure 34)



FIGURE 33

FIGURE 34

22. Reinstall both side plates using Phillips screwdriver. If a Co-Pilot was uninstalled, use new $\frac{1}{4}$ -20 x $\frac{5}{8}$ " Phillips screws provided. (Figure 35)
23. If a foot pedal is connected to the trolling motor, it must be disconnected. Once i-Pilot Link has been installed the foot pedal cannot be used unless i-Pilot Link is completely uninstalled.
24. Connect i-Pilot Link controller cable to the foot pedal connector, making sure the connector nut is tight (Figure 36)

IMPORTANT: DO NOT place dielectric grease or any type of lubricant in the connector.

25. i-Pilot Link is now installed on the motor. Skip ahead to the next section to verify the installation.



FIGURE 35







FIGURE 36

VERIFYING INSTALLATION OF I-PILOT LINK CONTROLLER AND REMOTE

It is important to verify your i-Pilot Link installation prior to going on the water. If this cannot be done, it is highly recommended that system verification be done in an open area on a calm day with a fully operational outboard motor for a backup means of powering your boat.

To verify that i-Pilot Link is working properly before going on the water, follow the steps below.

1. Trolling motor should be correctly installed and mounted to the bow of a boat.
2. The boat and trolling motor must be located outside and have a direct view of the sky to obtain GPS satellite signals.
3. Verify that all obstructions are away from the prop in all directions in both the stowed and deployed positions.
4. Connect power to the trolling motor.
5. Deploy the motor so the motor shaft is completely vertical.
6. The i-Pilot Link controller will emit four short beeps on startup.
7. Turn on the remote by pressing the OK key and verify the LCD comes on.
8. When i-Pilot Link is powered up, it starts to gather satellite information about its location. A minimum satellite signal level must be achieved before all i-Pilot Link functionality is available. This minimum level is one bar on the GPS signal icon. With no bars showing, only manual functions will be available.
9. Verify all manual functions by pressing     and .
10. If you experience any problems with any of the steps above, or cannot obtain a GPS satellite signal, refer to the troubleshooting section.

CONNECT THE I-PILOT LINK TO THE HUMMINBIRD FISHFINDER

The i-Pilot Link can be connected directly to the Humminbird Fishfinder or to the Humminbird Ethernet Switch (optional). If you purchase the Ethernet Switch, install it using the instructions in the Ethernet Accessory Guide.

WARNING!

The power source must be turned off before you proceed with this installation.

*NOTE: The Ethernet extension cable is optional for your installation. If you need to purchase additional extension cables, visit our website at humminbird.com or call the Humminbird Customer Resource Center at **1-800-633-1468**.*

1. Locate the Ethernet cable on the i-Pilot Link.
2. **If you are using the Ethernet extension cable for your installation**, connect it to the Ethernet cable on the i-Pilot Link. The connectors are keyed to prevent reversed installation, so be careful not to force the connectors together. Hand-tighten the screw nut.

If you do not need the Ethernet extension cable for your installation, proceed to step 3.

3. Route the cable to the Humminbird Fishfinder (or the optional Ethernet Switch).

NOTE: The cable should be routed through an established routing system on the boat, in an area with minimal interference. Inspect the selected route carefully to ensure that there are no sharp edges, obstacles, or obstructions that may damage the cables.

4. **700 Series:** Connect the Ethernet Cable to the Ethernet Adapter Cable (AS EC QDE). Insert the connector into the Ethernet port on the cable collector. See your Humminbird installation guide for details about installing the quick disconnect mount.

800/900/1100 Series: Insert the other end of the Ethernet Cable into the Ethernet port on the Fishfinder. Hand-tighten the screw nut.

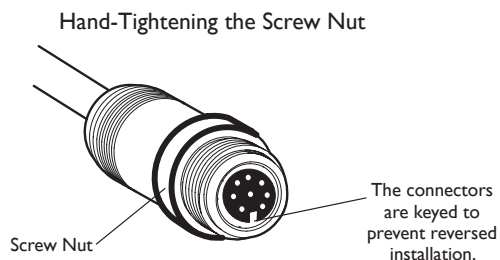

700 Series Cable Collector with Ethernet

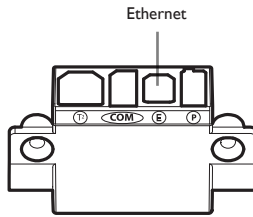

800/900 Series (rear view)

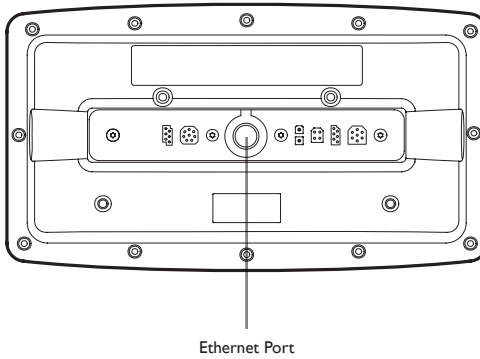

1100 Series (rear view)

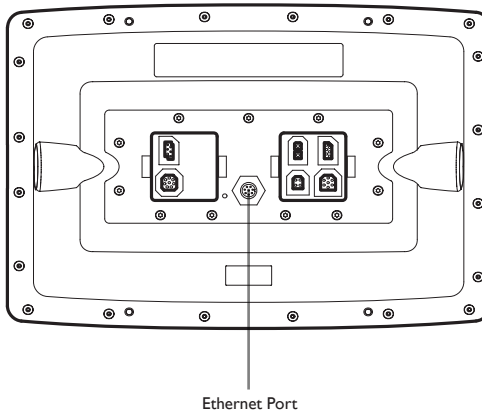

INSTALLATION GUIDE

VERIFYING INSTALLATION ON THE HUMMINBIRD FISHFINDER

All equipment should be connected and powered before you turn on the Fishfinder. When the i-Pilot Link is detected, **i-Pilot Link Connected** will display briefly on the screen. You can also confirm the installation connections using the following instructions.

1. Press the  POWER/LIGHT key on the Fishfinder.
2. When the Title screen is displayed, press the MENU key to open the Start-Up Options Menu.
3. Use the 4-WAY Cursor Control key to select Normal, and press the RIGHT Cursor key.
4. Press and hold the VIEW key. Select System > Accessory Test. Confirm that i-Pilot Link is listed as connected. It may take a minute for the equipment to be detected.
5. Press and hold the VIEW key. Select System > GPS Diagnostic View. Confirm that External GPS is displayed and the Fix Type indicates Enhanced or 3D.

Title Screen



NOTE: A GPS Receiver is required to enable the navigation features on the Fishfinder. The Fishfinder uses the data from the GPS Receiver attached directly to it or selected from the Ethernet network.

NOTE: If the GPS Diagnostic View or Accessory Test is not displayed in the View Rotation, press the MENU key twice to open the Main Menu. Select the Views tab > GPS Diagnostic View or Accessory Test. Change the setting for each view to Visible.

Confirming that i-Pilot Link is Detected

SYSTEM STATUS	
ACCESSORY TEST	
Aux. Temperature	UNCONNECTED
CannonLink	UNCONNECTED
GPS	CONNECTED
Interlink	UNCONNECTED
Speed	UNCONNECTED
Temperature	UNCONNECTED
WeatherSense	UNCONNECTED
XM Weather	UNCONNECTED
iPilot v.1.036	CONNECTED

Depth	m	Speed	kph	CGG	°t VLT	V
197	N 34°36.849'	0.0	216	13.8		
	W 084°37.909'					

GPS listed as connected
i-Pilot Link listed as connected

Confirming the GPS Fix Type

GPS Diagnostic View			
		Fix Type	Enhanced
		HDOP	1.00
		Est Pos Error	177ft
		Altitude	1083ft
		Speed	5.6mph
		Course	277°t
External GPS			
7/19/07	NORTH	25°53.999'	SD Card
11:58:45 AM	WEST	080°07.648'	43/120MB
		SD Card	--
Depth	ft	Temp	°F
36.4	74.3	5.6	277
		Speed	mph
		Course	°t VLT
			V

Fix Type should be 3D or Enhanced



CONSUMER & TECHNICAL SERVICE

Johnson Outdoors Marine Electronics, Inc.

PO Box 8129

121 Power Drive

Mankato, MN 56001

Phone (800) 227-6433

Fax (800) 527-4464

minnkotamotors.com



A Johnson Outdoors Company

©2013 Johnson Outdoors Marine Electronics, Inc. All rights reserved.

Conforms to 89/336/EEC (EMC) under standards EN 55022A, EN 50082-2 since 1996 LN V9677264

WARNING: This product contains chemical(s) known to the state of California to cause cancer and/or reproductive toxicity.