

Choose the language

English

Italiano

Deutsch

Français

Español

Sushi Sizes

Depth 90 cm Depth 35³/₈"

90	150 cm 59"	→ Fenix-NTM® → DEKTON®
	150/187/224 cm 59/73 ⁵ / ₈ /88 ² / ₈ "	→ Fenix-NTM®
	150/187/224 cm 59/73 ⁵ / ₈ /88 ² / ₈ "	→ DEKTON®
	177 cm 69 ³ / ₄ "	→ Fenix-NTM® → DEKTON®
	177/214/251/288 cm 69 ³ / ₄ /84 ² / ₈ /98 ⁷ / ₈ /113 ³ / ₈ "	→ Fenix-NTM®
	177/214/251 cm 69 ³ / ₄ /84 ² / ₈ /98 ⁷ / ₈ "	→ DEKTON®
	200 cm 78 ³ / ₄ "	→ Fenix-NTM® → DEKTON®
	200/237/274 cm 78 ³ / ₄ /93 ¹ / ₄ /107 ⁷ / ₈ "	→ Fenix-NTM®
	200/237/274 cm 78 ³ / ₄ /93 ¹ / ₄ /107 ⁷ / ₈ "	→ DEKTON®
	220 cm 86 ⁵ / ₈ "	→ Fenix-NTM®
	220/257/294 cm 86 ⁵ / ₈ /101 ² / ₈ /116 ¹ / ₈ "	→ Fenix-NTM®

Depth 90 cm Depth 35³/₈"

90	161 cm 63 ³ / ₈ "	→ Fenix-NTM®
	180 cm 70 ⁷ / ₈ "	→ Fenix-NTM®
	215 cm 84 ⁵ / ₈ "	→ Fenix-NTM®
	270 cm 106 ² / ₈ "	→ Fenix-NTM®

Bench

Depth 41 cm Depth 16¹/₈"

41	123 cm 48 ³ / ₈ "	→ Fenix-NTM®
	144 cm 56 ³ / ₄ "	→ Fenix-NTM®
	162 cm 63 ⁷ / ₈ "	→ Fenix-NTM®

Depth 100 cm Depth 39³/₈"

100	177 cm 69 ³ / ₄ "	→ Fenix-NTM® → DEKTON®
	177/224/271 cm 69 ³ / ₄ /88 ² / ₈ /106 ³ / ₄ "	→ Fenix-NTM®
	177/214/251 cm 69 ³ / ₄ /84 ² / ₈ /98 ⁷ / ₈ "	→ DEKTON®
	200 cm 78 ³ / ₄ "	→ Fenix-NTM® → DEKTON®
	200/247/294 cm 78 ³ / ₄ /97 ² / ₈ /115 ³ / ₄ "	→ Fenix-NTM®
	200/237/274 cm 78 ³ / ₄ /93 ¹ / ₄ /107 ⁷ / ₈ "	→ DEKTON®
	220 cm 86 ⁵ / ₈ "	→ Fenix-NTM®
	220/267/314 cm 86 ⁵ / ₈ /105 ¹ / ₈ /123 ³ / ₄ "	→ Fenix-NTM®
	240 cm 94 ⁴ / ₈ "	→ DEKTON®
	280 cm 110 ² / ₈ "	→ DEKTON®

* = 3rd additional extension (on request)

Tops

Depth 136 cm
Depth 53 4/8"

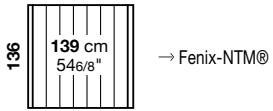

Fenix-NTM® black edge 10 mm thick

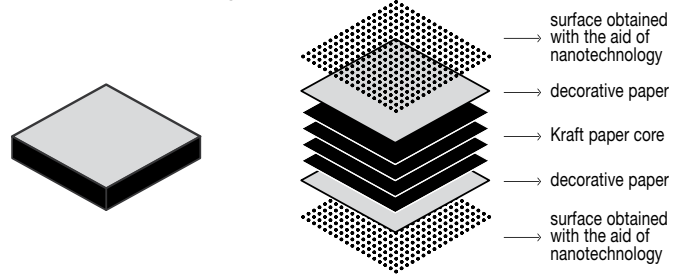

DEKTON® by Cosentino 8 mm thick



Sushi slatted Fenix-NTM®

Fixed - Depth 90/136 cm.

Finish of structure:

Anodised aluminium

Leg finish:

Anodised aluminium

White lacquered aluminium (similar to RAL 9016)

"Fenix-NTM® Bromo grey" lacquered aluminium (similar to RAL 7012)

Olive green painted aluminium (colour ref. "Olive green PO08 polyurethane")

Finish of top:

Fenix-NTM® black edge (Kos white 0032, Bromo grey 0724)

→ Tables that extend to more than 250 cm have a top that slightly bends, which complies with accepted quality standards.

→ Reinforced packaging, see inside of cover.

→ "Casper" protective cover, see page 74.

Fixed (II)

Code	Length (cm.)	Depth	Legs	Top	Price in EURO	Packs	Vol. ³	Kg
01SUS40F	161	90	aluminium	Fenix black edge		1	0,42	45
			lacquered	Fenix black edge				
01SUS41F	180	90	aluminium	Fenix black edge		1	0,42	48
			lacquered	Fenix black edge				
01SUS42F	215	90	aluminium	Fenix black edge		1	0,5	57
			lacquered	Fenix black edge				
01SUS44F	270	90	aluminium	Fenix black edge		1	0,57	68
			lacquered	Fenix black edge				
01SUS46F	139	136	aluminium	Fenix black edge		1	0,49	57
			lacquered	Fenix black edge				

Optionals

Code	Depth	Price in EURO	Packs	Vol. ³	Kg
02GTA02	 legs height cut to size		-	-	-

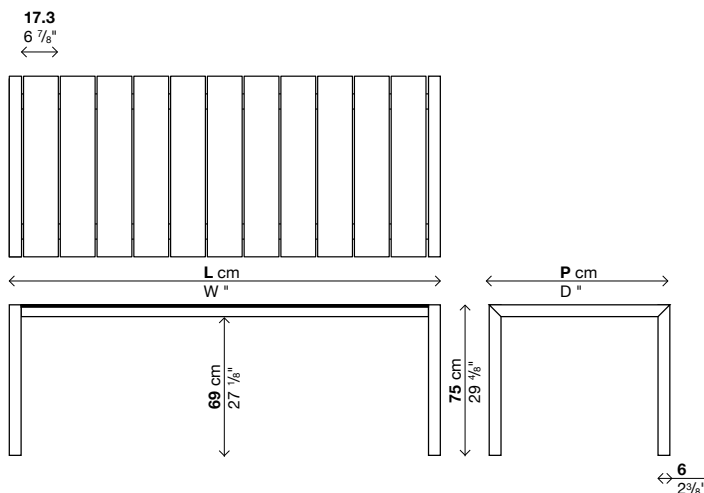

Sushi slatted bench

Finish of structure:

Anodised aluminium

Leg finish:

Anodised aluminium

White lacquered aluminium (similar to RAL 9016)

"Fenix-NTM® Bromo grey" lacquered aluminium (similar to RAL 7012)

Olive green painted aluminium (colour ref. "Olive green PO08 polyurethane")

Finish of top:

Fenix-NTM® black edge (Kos white 0032, Bromo grey 0724)

Bench

Code	Length (cm.)	Depth	Legs	Top	Price in EURO	Packs	Vol. ³	Kg
05SUS50	123	41	aluminium	Fenix black edge		1	0,16	24
			lacquered	Fenix black edge				
05SUS51	144	41	aluminium	Fenix black edge		1	0,18	26
			lacquered	Fenix black edge				
05SUS52	162	41	aluminium	Fenix black edge		1	0,2	29
			lacquered	Fenix black edge				

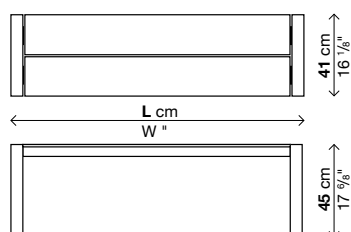



Sushi

Legenda dimensioni

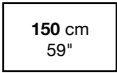
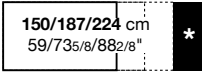
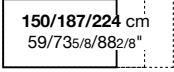
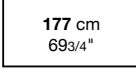
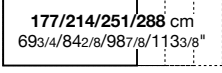
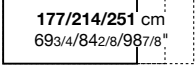
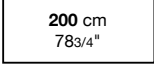
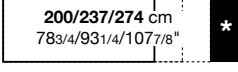
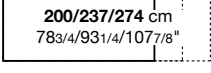
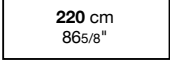
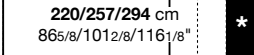
Prof. 90 cm
Depth 35³/₈"

90		→ Fenix-NTM® → DEKTON®
		→ Fenix-NTM®
		→ DEKTON®
		→ Fenix-NTM® → DEKTON®
		→ Fenix-NTM®
		→ DEKTON®
		→ Fenix-NTM® → DEKTON®
		→ Fenix-NTM®
		→ DEKTON®
		→ Fenix-NTM®
		→ Fenix-NTM®

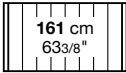
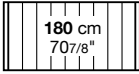
Prof. 90 cm
Depth 35³/₈"



90		→ Fenix-NTM®
		→ Fenix-NTM®
		→ Fenix-NTM®
		→ Fenix-NTM®

Panchetta

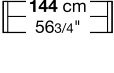
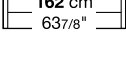
Prof. 41 cm
Depth 16¹/₈"

41		→ Fenix-NTM®
		→ Fenix-NTM®
		→ Fenix-NTM®

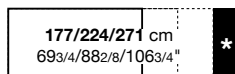
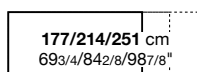
Prof. 100 cm
Depth 39³/₈"

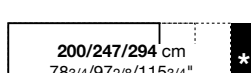
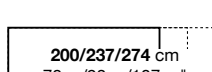
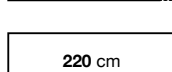
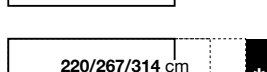
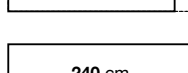
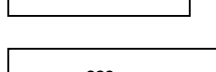
100		→ Fenix-NTM® → DEKTON®
		→ Fenix-NTM®
		→ DEKTON®
		→ Fenix-NTM® → DEKTON®
		→ Fenix-NTM®
		→ DEKTON®
		→ Fenix-NTM®
		→ Fenix-NTM®
		→ DEKTON®
		→ DEKTON®

* = 3° prolunga aggiuntiva (a richiesta)

Piani

Prof. 136 cm
Depth 53 4/8"

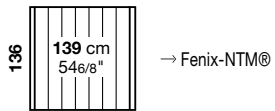

Fenix-NTM® bordo nero Sp. 10 mm

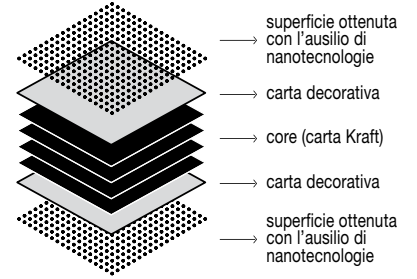
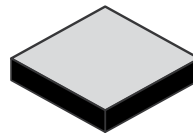

DEKTON® by Cosentino Sp. 8 mm

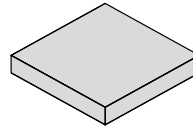

Dekton è una sofisticata miscela di materie prime utilizzate per la creazione di vetro, ceramica di ultima generazione e superfici in quarzo di altissima qualità

Sushi slatted Fenix-NTM®

Fisso - Prof. 90/136 cm.

Finitura struttura:

Alluminio anodizzato

Finitura gambe:

Alluminio anodizzato

Alluminio verniciato bianco (simile al Ral 9016)

Alluminio verniciato "Fenix-NTM® grigio Bromo" (simile al Ral 7012)

Alluminio verniciato verde oliva (rif. colore "Poliuretano verde oliva PO08")

Finitura piano:

Fenix-NTM® bordo nero (bianco Kos 0032, grigio Bromo 0724)

→ I tavoli che in estensione superano i 250 cm presentano una leggera flessione del piano, che rientra negli standard di qualità accettati.

→ Imballi rinforzati vedi interno di copertina.

→ Copertura protettiva "Casper" vedi pag. 74.

Fisso (II)

Codice	Lunghezza (cm.)	Prof.	Gambe	Piano	Prezzi EURO	coll.	m ²	Kg
01SUS40F	161	90	alluminio	Fenix bordo nero		1	0,42	45
			verniciato	Fenix bordo nero				
01SUS41F	180	90	alluminio	Fenix bordo nero		1	0,42	48
			verniciato	Fenix bordo nero				
01SUS42F	215	90	alluminio	Fenix bordo nero		1	0,5	57
			verniciato	Fenix bordo nero				
01SUS44F	270	90	alluminio	Fenix bordo nero		1	0,57	68
			verniciato	Fenix bordo nero				
01SUS46F	139	136	alluminio	Fenix bordo nero		1	0,49	57
			verniciato	Fenix bordo nero				

Optionals

Codice	Prof		Prezzi EURO	coll.	m ²	Kg
02GTA02		taglio gambe a misura		-	-	-

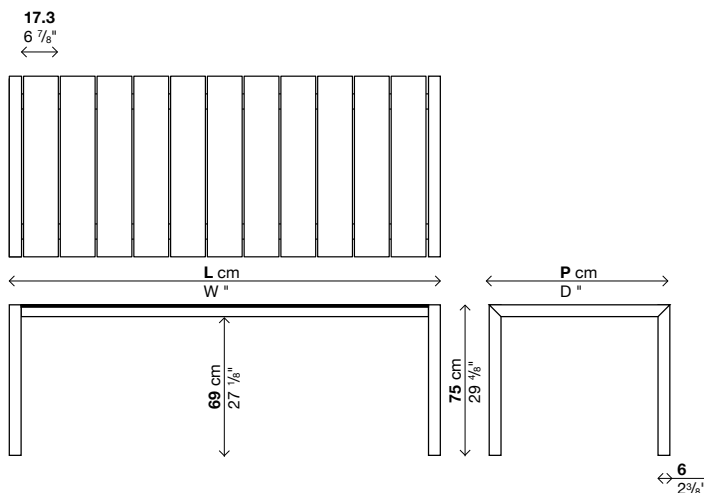

Sushi slatted panchetta

Finitura struttura:

Alluminio anodizzato

Finitura gambe:

Alluminio anodizzato

Alluminio verniciato bianco (simile al Ral 9016)

Alluminio verniciato "Fenix-NTM® grigio Bromo" (simile al Ral 7012)

Alluminio verniciato verde oliva (rif. colore "Poliuretano verde oliva PO08")

Finitura piano:

Fenix-NTM® bordo nero (bianco Kos 0032, grigio Bromo 0724)

Panchetta

Codice	Lunghezza (cm.)	Prof.	Gambe	Piano	Prezzi EURO	coll.	m ²	Kg
05SUS50	123	41	alluminio	Fenix bordo nero		1	0,16	24
			verniciato	Fenix bordo nero				
05SUS51	144	41	alluminio	Fenix bordo nero		1	0,18	26
			verniciato	Fenix bordo nero				
05SUS52	162	41	alluminio	Fenix bordo nero		1	0,2	29
			verniciato	Fenix bordo nero				

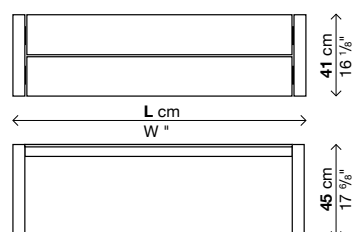

Sushi

Größenübersicht

Breite 90 cm
Breite 35³/₈"

90	150 cm 59"	→ Fenix-NTM® → DEKTON®
	150/187/224 cm 59/73 ⁵ / ₈ /88 ² / ₈ " *	→ Fenix-NTM®
	150/187/224 cm 59/73 ⁵ / ₈ /88 ² / ₈ "	→ DEKTON®
	177 cm 69 ³ / ₄ "	→ Fenix-NTM® → DEKTON®
	177/214/251/288 cm 69 ³ / ₄ /84 ² / ₈ /98 ⁷ / ₈ /113 ³ / ₈ "	→ Fenix-NTM®
	177/214/251 cm 69 ³ / ₄ /84 ² / ₈ /98 ⁷ / ₈ "	→ DEKTON®
	200 cm 78 ³ / ₄ "	→ Fenix-NTM® → DEKTON®
	200/237/274 cm 78 ³ / ₄ /93 ¹ / ₄ /107 ⁷ / ₈ " *	→ Fenix-NTM®
	200/237/274 cm 78 ³ / ₄ /93 ¹ / ₄ /107 ⁷ / ₈ "	→ DEKTON®
	220 cm 86 ⁵ / ₈ "	→ Fenix-NTM®
	220/257/294 cm 86 ⁵ / ₈ /101 ² / ₈ /116 ¹ / ₈ " *	→ Fenix-NTM®

Breite 90 cm
Breite 35³/₈"

90	161 cm 63 ³ / ₈ "	→ Fenix-NTM®
	180 cm 70 ⁷ / ₈ "	→ Fenix-NTM®
	215 cm 84 ⁵ / ₈ "	→ Fenix-NTM®
	270 cm 106 ² / ₈ "	→ Fenix-NTM®

Sitzbank

Breite 41 cm
Breite 16¹/₈"

41	123 cm 48 ³ / ₈ "	→ Fenix-NTM®
	144 cm 56 ³ / ₄ "	→ Fenix-NTM®
	162 cm 63 ⁷ / ₈ "	→ Fenix-NTM®

Breite 100 cm
Breite 39³/₈"

100	177 cm 69 ³ / ₄ "	→ Fenix-NTM® → DEKTON®
	177/224/271 cm 69 ³ / ₄ /88 ² / ₈ /106 ³ / ₄ " *	→ Fenix-NTM®
	177/214/251 cm 69 ³ / ₄ /84 ² / ₈ /98 ⁷ / ₈ "	→ DEKTON®
	200 cm 78 ³ / ₄ "	→ Fenix-NTM® → DEKTON®
	200/247/294 cm 78 ³ / ₄ /97 ² / ₈ /115 ³ / ₄ " *	→ Fenix-NTM®
	200/237/274 cm 78 ³ / ₄ /93 ¹ / ₄ /107 ⁷ / ₈ "	→ DEKTON®
	220 cm 86 ⁵ / ₈ "	→ Fenix-NTM®
	220/267/314 cm 86 ⁵ / ₈ /105 ¹ / ₈ /123 ³ / ₄ " *	→ Fenix-NTM®
	240 cm 94 ⁴ / ₈ "	→ DEKTON®
	280 cm 110 ² / ₈ "	→ DEKTON®

* = 3. zusätzliche Verlängerung (auf Anfrage)

Platten

Breite 136 cm
Breite 53 4/8"

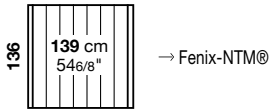

Fenix-NTM® schwarze Kante St. 10 mm

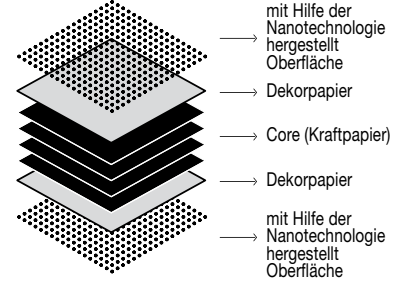
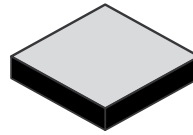

DEKTON® by Cosentino St. 8 mm

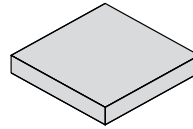

Dekton ist ein hoch entwickeltes Rohstoffgemisch, das für die Erzeugung von Glas, Keramik der letzten Generation und Quarzoberflächen mit höchster Qualität eingesetzt wird.

Sushi slatted Fenix-NTM®

Fixmaße - Breite 90/136 cm.

Strukturausführung:

Eloxiertes Aluminium

Ausführung der Beine:

Eloxiertes Aluminium

Weiß lackiertes Aluminium (farbähnlich wie Ral 9016)

“Fenix-NTM® Grau Bromo” lackiertes Aluminium (farbähnlich wie Ral 7012)

Olivgrün lackiertes Aluminium (farbähnlich wie “Polyurethan Olivgrün PO08”)

Ausführung der Tischplatte:

Fenix-NTM® mit schwarzer Kante (Weiß Kos 0032, Grau Bromo 0724)

→ Jene Tische, die im ausgezogenen Zustand eine Länge von 250 cm überschreiten, weisen eine leichte Biegung der Platte auf, die jedoch innerhalb der festgelegten qualitativen Standards liegt.

→ Für verstärkte Verpackungen siehe Innenseite des Umschlags.

→ **Schutzhülle “Casper” siehe Seite 74.**

Fixmaße (II)

Art.-Nr.	Länge (cm)	Breite	Beine	Platte	Preis in EURO	Kolli / V.m³ / Kg
01SUS40F	161	90	Aluminium Lackiert	Fenix schwarze Kante Fenix schwarze Kante		1 0,42 45
01SUS41F	180	90	Aluminium Lackiert	Fenix schwarze Kante Fenix schwarze Kante		1 0,42 48
01SUS42F	215	90	Aluminium Lackiert	Fenix schwarze Kante Fenix schwarze Kante		1 0,5 57
01SUS44F	270	90	Aluminium Lackiert	Fenix schwarze Kante Fenix schwarze Kante		1 0,57 68
01SUS46F	139	136	Aluminium Lackiert	Fenix schwarze Kante Fenix schwarze Kante		1 0,49 57

Optionals

Art.-Nr.	Breite	Preis in EURO	Kolli / V.m³ / Kg
02GTA02		Zuschnitt der Beine nach Maß	- - -

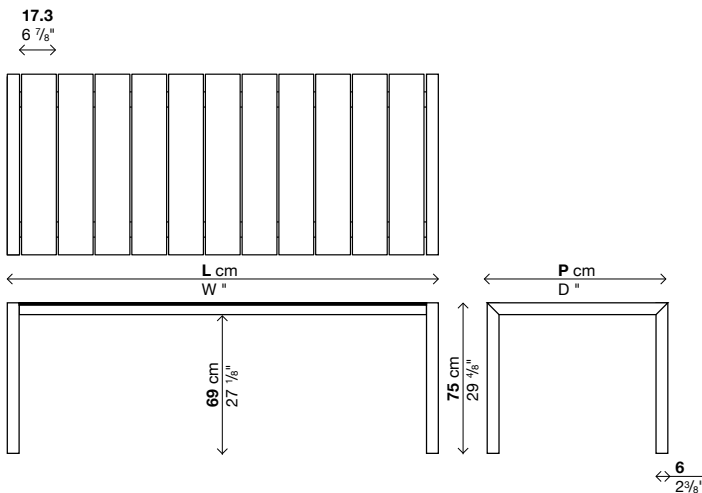

Sushi slatted Bankelement

Strukturausführung:

Eloxiertes Aluminium

Ausführung der Beine:

Eloxiertes Aluminium

Weiß lackiertes Aluminium (farbähnlich wie Ral 9016)

“Fenix-NTM® Grau Bromo” lackiertes Aluminium (farbähnlich wie Ral 7012)

Olivgrün lackiertes Aluminium (farbähnlich wie “Polyurethan Olivgrün PO08”)

Ausführung der Tischplatte:

Fenix-NTM® mit schwarzer Kante (Weiß Kos 0032, Grau Bromo 0724)

Sitzbank

Art.-Nr.	Länge (cm)	Breite	Beine	Platte	Preis in EURO	Kolli / V.m³ / Kg
05SUS50	123	41	Aluminium Lackiert	Fenix schwarze Kante Fenix schwarze Kante		1 0,16 24
05SUS51	144	41	Aluminium Lackiert	Fenix schwarze Kante Fenix schwarze Kante		1 0,18 26
05SUS52	162	41	Aluminium Lackiert	Fenix schwarze Kante Fenix schwarze Kante		1 0,2 29

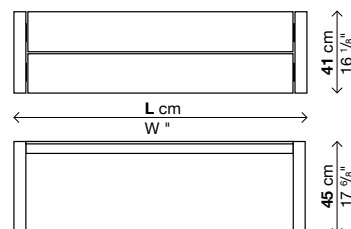



Sushi

Dimensions

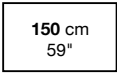
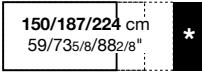
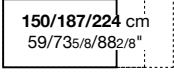
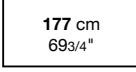
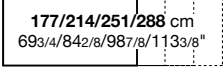
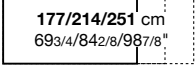
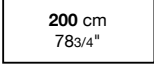
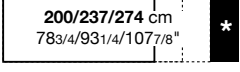
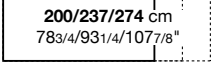
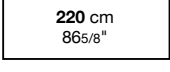
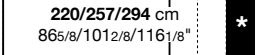
Prof. 90 cm
Prof. 35³/₈"

90		→ Fenix-NTM® → DEKTON®
		→ Fenix-NTM®
		→ DEKTON®
		→ Fenix-NTM® → DEKTON®
		→ Fenix-NTM®
		→ DEKTON®
		→ Fenix-NTM® → DEKTON®
		→ Fenix-NTM®
		→ DEKTON®
		→ Fenix-NTM®
		→ Fenix-NTM®

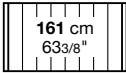
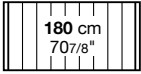
Prof. 90 cm
Prof. 35³/₈"

90		→ Fenix-NTM®
		→ Fenix-NTM®
		→ Fenix-NTM®
		→ Fenix-NTM®

Banc

Prof. 41 cm
Prof. 16¹/₈"

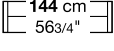
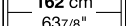
41		→ Fenix-NTM®
		→ Fenix-NTM®
		→ Fenix-NTM®

Prof. 100 cm
Prof. 39³/₈"

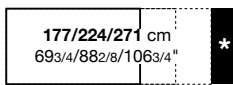
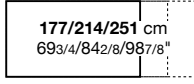
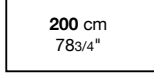
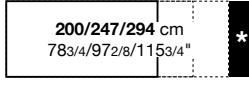
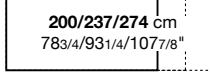
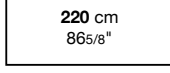
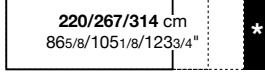
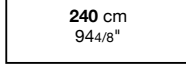
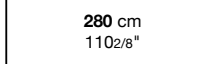
100		→ Fenix-NTM® → DEKTON®
		→ Fenix-NTM®
		→ DEKTON®
		→ Fenix-NTM® → DEKTON®
		→ Fenix-NTM®
		→ DEKTON®
		→ Fenix-NTM®
		→ Fenix-NTM®
		→ DEKTON®
		→ DEKTON®

* = 3ème rallonge supplémentaire (sur demande)

Plateaux

Prof. 136 cm
Prof. 53 4/8"

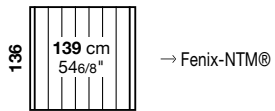

Fenix-NTM® chant noir Ép. 10 mm

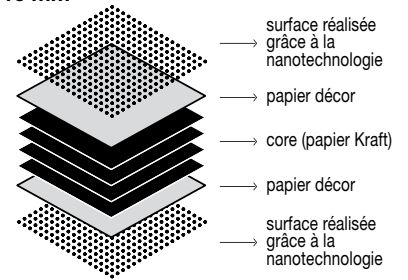
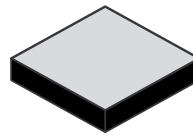

DEKTON® by Cosentino Ép. 8 mm

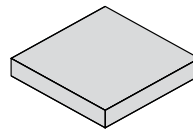

Dekton est un mélange sophistiqué de matières premières utilisées pour la fabrication du verre, de céramique de dernière génération et de surfaces en quartz de très haute qualité

Sushi slatted Fenix-NTM®

Fixe - Prof. 90/136 cm.

Finition de la structure:

Aluminium anodisé

Finition piètement:

Aluminium anodisé

Aluminium laqué blanc (semblable au Ral 9016)

Aluminium laqué "Fenix-NTM® gris Bromo" (semblable au Ral 7012)

Aluminium laqué vert olive (coloris de référence "Polyuréthane vert olive PO08")

Finition du plateau:

Fenix-NTM® chant noir (blanc Kos 0032, gris Bromo 0724)

→ Les tables qui une fois allongées font plus de 250 cm présentent une légère flexion du plateau qui respecte les standards de qualité acceptés.

→ Pour emballages renforcés, voir intérieur de la couverture.

→ Housse de protection "Casper", voir page 74.

Fixe (II)

Code	Longueur (cm.)	Prof.	Pieds	Plateau	Prix en EURO	Cols	m ²	Kg
01SUS40F	161	90	aluminium	Fenix chant noir		1	0,42	45
			laqué	Fenix chant noir				
01SUS41F	180	90	aluminium	Fenix chant noir		1	0,42	48
			laqué	Fenix chant noir				
01SUS42F	215	90	aluminium	Fenix chant noir		1	0,5	57
			laqué	Fenix chant noir				
01SUS44F	270	90	aluminium	Fenix chant noir		1	0,57	68
			laqué	Fenix chant noir				
01SUS46F	139	136	aluminium	Fenix chant noir		1	0,49	57
			laqué	Fenix chant noir				

Optionals

Code	Prof		Prix en EURO	Cols	m ²	Kg
02GTA02		coupe des pieds sur mesure		-	-	-

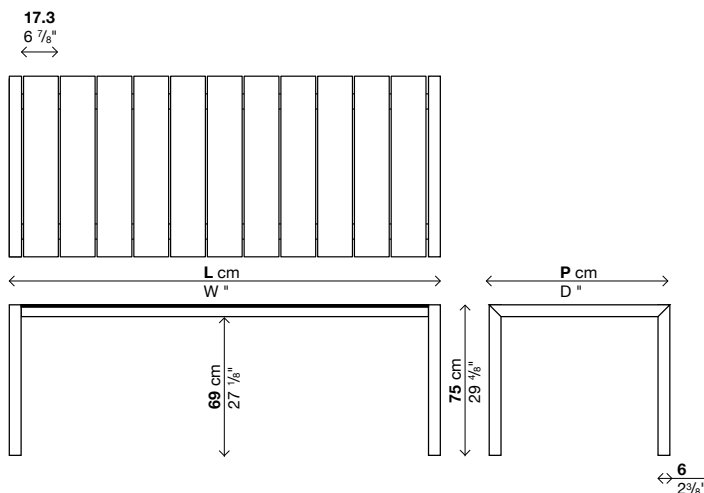

Banquette Sushi slatted

Finition de la structure:

Aluminium anodisé

Finition piètement:

Aluminium anodisé

Aluminium laqué blanc (semblable au Ral 9016)

Aluminium laqué "Fenix-NTM® gris Bromo" (semblable au Ral 7012)

Aluminium laqué vert olive (coloris de référence "Polyuréthane vert olive PO08")

Finition du plateau:

Fenix-NTM® chant noir (blanc Kos 0032, gris Bromo 0724)

Banc

Code	Longueur (cm.)	Prof.	Pieds	Plateau	Prix en EURO	Cols	m ²	Kg
05SUS50	123	41	aluminium laqué	Fenix chant noir Fenix chant noir		1	0,16	24
05SUS51	144	41	aluminium laqué	Fenix chant noir Fenix chant noir		1	0,18	26
05SUS52	162	41	aluminium laqué	Fenix chant noir Fenix chant noir		1	0,2	29

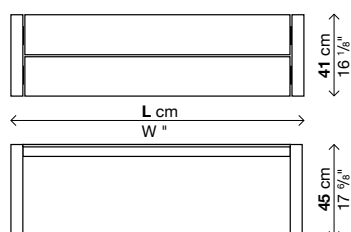

Sushi

Dimensiones

Prof. 90 cm
Prof. 35³/₈"

90		→ Fenix-NTM® → DEKTON®
		→ Fenix-NTM®
		→ DEKTON®
		→ Fenix-NTM® → DEKTON®
		→ Fenix-NTM®
		→ DEKTON®
		→ Fenix-NTM® → DEKTON®
		→ Fenix-NTM®
		→ DEKTON®
		→ Fenix-NTM®
		→ Fenix-NTM®

Prof. 90 cm
Prof. 35³/₈"

90		→ Fenix-NTM®
		→ Fenix-NTM®
		→ Fenix-NTM®
		→ Fenix-NTM®

Banco

Prof. 41 cm
Prof. 16¹/₈"

41		→ Fenix-NTM®
		→ Fenix-NTM®
		→ Fenix-NTM®

Prof. 100 cm
Prof. 39³/₈"

100		→ Fenix-NTM® → DEKTON®
		→ Fenix-NTM®
		→ DEKTON®
		→ Fenix-NTM® → DEKTON®
		→ Fenix-NTM®
		→ DEKTON®
		→ Fenix-NTM®
		→ Fenix-NTM®
		→ DEKTON®
		→ DEKTON®

* = 3ª prolongación adicional (bajo petición)

Sobres

Prof. 136 cm
Prof. 534/8"

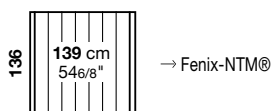

Fenix-NTM® borde negro Esp. 10 mm

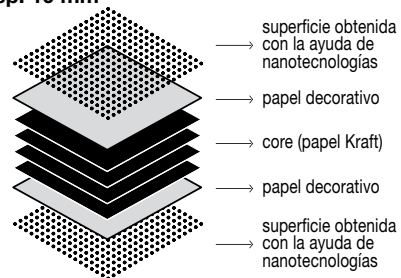
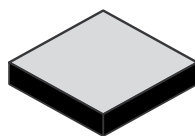

DEKTON® by Cosentino Esp. 8 mm

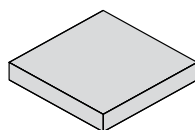

Dekton es una sofisticada mezcla de materias primas utilizadas para la creación de cristal, cerámica de última generación y superficies de cuarzo de altísima calidad

Sushi slatted Fenix-NTM®

Fija - Prof. 90/136 cm.

Acabado estructura:

Aluminio anodizado

Acabado patas:

Aluminio anodizado

Aluminio barnizado blanco (parecido al Ral 9016)

Aluminio barnizado "Fenix-NTM® gris Bromo" (parecido al Ral 7012)

Aluminio barnizado verde oliva (ref. color "Poliuretano verde oliva PO08")

Acabado sobre:

Fenix-NTM® borde negro (blanco Kos 0032, gris Bromo 0724)

→ Las mesas que superan los 250 cm extendidas presentan una ligera flexión del sobre que respeta los estándares de calidad aceptados.

→ Embalajes reforzados, ver lado interno de la portada.

→ Funda de protección "Casper" ver pág. 74.

Fija (II)

Código	Longitud (cm.)	Prof.	Patatas	Sobre	Precios EURO	Packs	Vol. m³	Kg
01SUS40F	161	90	aluminio	Fenix borde negro		1	0,42	45
			barnizado	Fenix borde negro				
01SUS41F	180	90	aluminio	Fenix borde negro		1	0,42	48
			barnizado	Fenix borde negro				
01SUS42F	215	90	aluminio	Fenix borde negro		1	0,5	57
			barnizado	Fenix borde negro				
01SUS44F	270	90	aluminio	Fenix borde negro		1	0,57	68
			barnizado	Fenix borde negro				
01SUS46F	139	136	aluminio	Fenix borde negro		1	0,49	57
			barnizado	Fenix borde negro				

Opcionales

Código	Prof		Precios EURO	Packs	Vol. m³	Kg
02GTA02		corte pata a medida		-	-	-

Sushi slatted banqueta

Acabado estructura:

Aluminio anodizado

Acabado patas:

Aluminio anodizado

Aluminio barnizado blanco (parecido al Ral 9016)

Aluminio barnizado "Fenix-NTM® gris Bromo" (parecido al Ral 7012)

Aluminio barnizado verde oliva (ref. color "Poliuretano verde oliva PO08")

Acabado sobre:

Fenix-NTM® borde negro (blanco Kos 0032, gris Bromo 0724)

Banco

Código	Longitud (cm.)	Prof.	Patatas	Sobre	Precios EURO	Packs	Vol. m³	Kg
05SUS50	123	41	aluminio	Fenix borde negro		1	0,16	24
			barnizado	Fenix borde negro				
05SUS51	144	41	aluminio	Fenix borde negro		1	0,18	26
			barnizado	Fenix borde negro				
05SUS52	162	41	aluminio	Fenix borde negro		1	0,2	29
			barnizado	Fenix borde negro				

