







SAINTE 05

Sainte is a collection about the forces that anchor us, a suspension light in dialogue with gravity. Reimagining the rectangle in layered, colourful glass, Sainte offers an elegant floating mass supported by robust nylon ribbons. Powered by a flat wire embedded in the nylon, these anchors carry a casual, contemporary spirit: an everyday material flirting with its graceful, minimalist centre. The form can suspend from any angle and height, and in multiples, offering infinite architectures and possibilities. As a collection, it presents a dance of contrasting materials and an equilibrium of opposing powers.

type:	suspension
construction:	aluminum polished light block and ceiling anchors float glass body nylon ribbon PMMA frosted diffuser
specifications:	source: LED array, integrated power consumption: 11W colour temperature 2700k, 3000k, dim to warm. see order guide colour rendering index: ≥ 90 CRI colour consistency: 3 SDCM expected lifetime: 50 000h
control:	120-277V: On/Off, 0-10V, Phase Dimming (120V only) 220-240V: On/Off, 0-10V, Phase Dimming (Trailing Edge only) refer to our recommended list of dimmer models
ribbon length:	20' / 610 cm, width: 2" / 5 cm
weight:	15.1 lb / 6.8 kg
certifications:	    IP20
warranty:	2 years

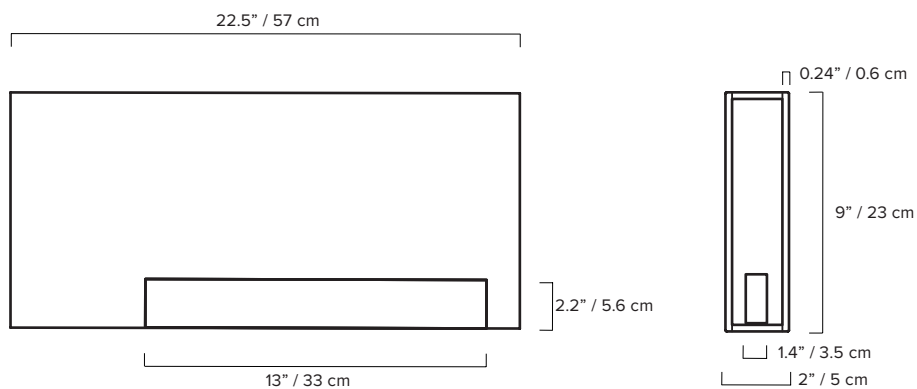

ORDER GUIDE: SKU

COLLECTION	MODEL	GLASS BODY SIDE A	GLASS BODY SIDE B
STE sainte	05	BK black	BK black
		GY grey	GY grey
		FG frosted grey	FG frosted grey
		EC extra clear	EC extra clear
		FC frosted extra clear	FC frosted extra clear
		GN green	GN green
		BZ bronze	BZ bronze
STE	05	BK	BK

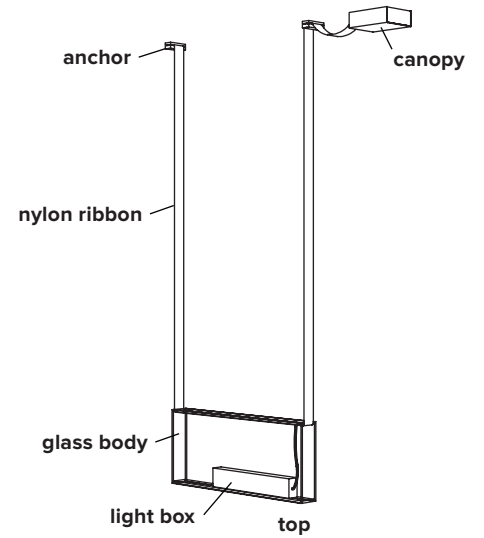

NYLON RIBBON	CANOPY	COLOUR TEMPERATURE (CCT)	CONTROL
BK black	BK black	WL warm light (2700K)	ZT 0-10V dimming
BG beige	WH white	NL neutral light (3000K)	OT 1-10V dimming
		DW dim to warm (2700K to 2200K)	PH phase dimming
		V variable	
BK	BK	WL	ZT

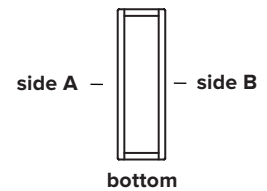

Top and bottom of glass are always ultraclear and not available in color

ZT = STE05BKBKKBKWLZT
example

GLASS BODY

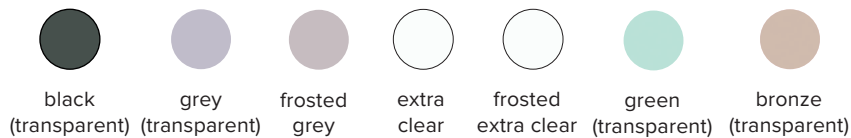

NYLON RIBBON

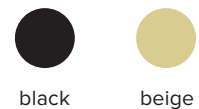

MOUNTING OPTIONS

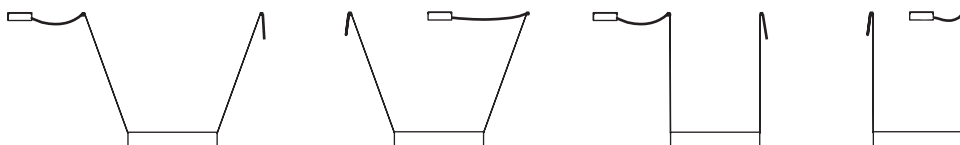

DIMMER SPECIFICATIONS

TESTED DIMMER COMPATIBILITY LIST - 120V*

Compatible with 0-10V, Phase dimming (leading edge or trailing edge**)

Dimmer brand	Model	Dimmer protocol	Min level	Max level
Lutron	TGCL-153P	Phase dimming	14%	98%
Leviton	VPE06	Phase dimming	14%	98%
Lutron	DVELV303P	Phase dimming	11%	98%
Lutron	SELV300P	Phase dimming	11%	98%
Lightolier	ZP260QEW	Phase dimming	11%	98%
Lutron	FAELV500	Phase dimming	17%	99%
Lutron	MAELV600	Phase dimming	18%	98%

TESTED DIMMER COMPATIBILITY LIST - 230V*

Compatible with 0-10V, Phase dimming (trailing edge only**)

Dimmer brand	Model	Dimmer protocol	Min level	Max level
Clipsal	32E450UDM	Phase dimming	31%	100%
Clipsal	32E450TM	Phase dimming	25%	100%

Some dimmers require a minimum load, check specifications.

*Other dimmers can yield good results and we recommend conducting your own test before final installation

**Leading edge is also known as TRIAC or Forward Phase. Trailing edge is also known as ELV or Reverse Phase.

EU ENERGY LABEL

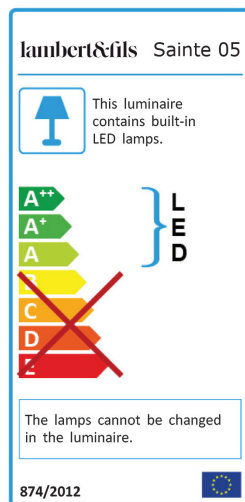

NOTES:

- must be installed by an electrician
- LED may only be changed by Lambert & Fils or other authorized personnel
- not protected against liquids (refer to IP20)
- additional charges for modifications or for special orders
- please refer to maintenance sheet on website for cleaning instructions