





MILE 03



A collaboration between Lambert & Fils and Guillaume Sasseville, Mile offers a variation on the linear suspension, pared down to its simplest, asymmetrical expression, with two lines floating in surprising equilibrium. Direct and indirect light are separated by a 90° pivot, thus marking out space with light. A play on contrasts, Mile is part art installation and part utilitarian light. The use of linear LED technology and the cords clamped into the structure add to the weightless, almost levitating feel of the lamp.

TYPE	Suspension
CONSTRUCTION	Powder coated or polished aluminum body Powder coated or polished steel anchors Powder coated steel canopy Frosted acrylic diffuser Polyester cord
SPECIFICATIONS	source: LED array, integrated Power consumption: 31W (120V), 27W (230V) Lumen output: LED 2700K - 2329lm (120V), 2038lm (230V) LED 3000K - 2400lm (120V), 2100lm (230V) Light distribution: 26% Up, 74% Down Colour rendering index: ≥ 90 CRI standard Colour consistency: 3 SDCM Expected lifetime: ≥ 50 000h
CONTROL	120/277V on/off, 0-10V or phase dimming (120V only) 220-240V: On/Off, Phase Dimming, DALI Refer to our recommended list of dimmer models
CORD LENGTH	Mains/line cord - 120" / 304 cm Non-electrical cord - 96" / 244 cm
WEIGHT	5.5 lb / 2.5 kg
CERTIFICATIONS	     IP20
WARRANTY	2 years

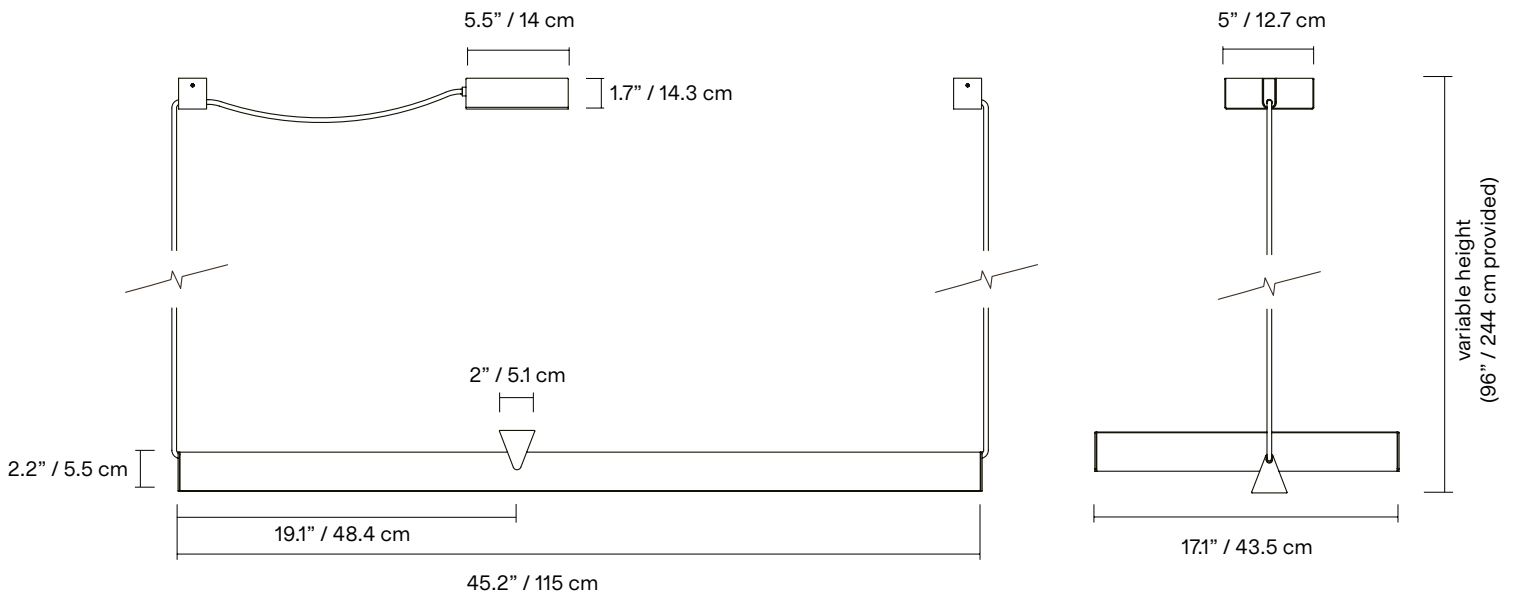
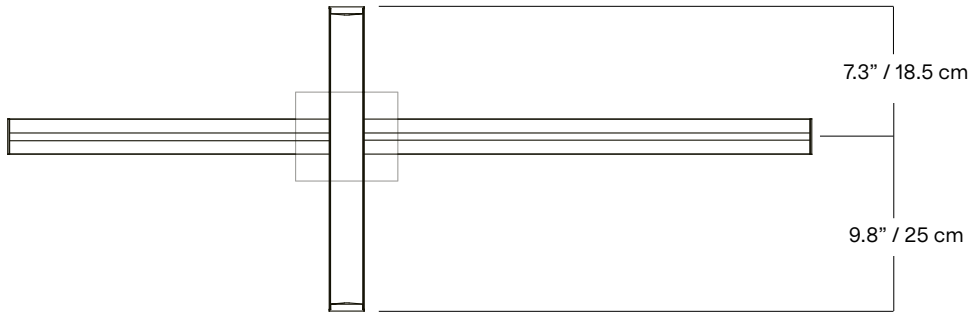

*dimensions are approximate and may vary slightly

FINISH



BK
Textured
black



WH
Textured
white



BG
Textured
beige



GN
Textured
green



BU
Textured
burgundy



AL
Polished
aluminum

NOTES

- Must be installed by an electrician
- LED may only be changed by Lambert & Fils or other authorized personnel
- Not protected against liquids (refer to IP20)
- Additional charges for modifications or for special orders
- Please refer to maintenance sheet on website for cleaning instructions

LAMP ANATOMY

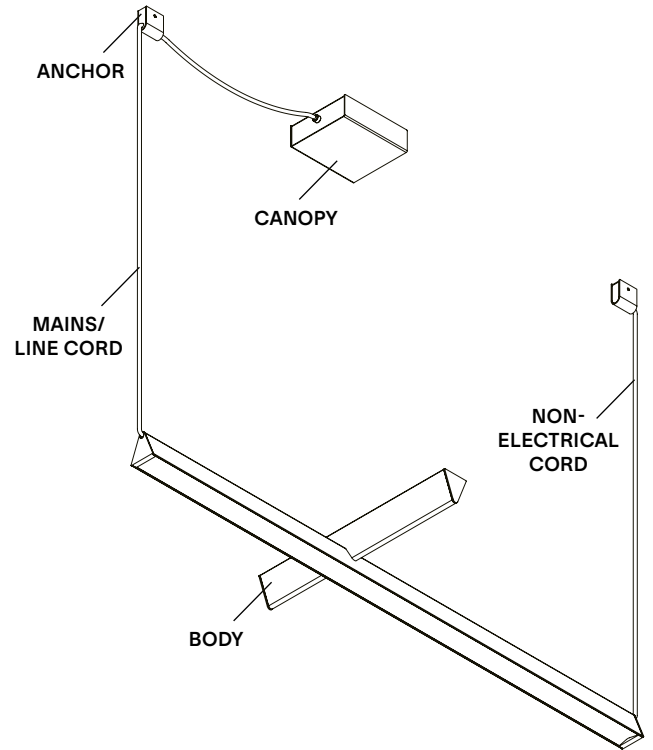

		Example	Fill with your selection
COLLECTION	MIL Mile	MIL	MIL
MODEL	03LV	03LV	03LV
FINISH BODY, CORD AND ANCHORS	AL Polished aluminum BK Textured black BG Textured beige BU Textured burgundy GN Textured green WH Textured white	BK	
CANOPY	BK Textured black BG Textured beige BU Textured burgundy GN Textured green WH Textured white	BK	
COLOUR TEMPERATURE (CCT)	WL Warm light (2700K) NL Neutral light (2700K) D27 Dim to warm (2700K to 2200K) D30 Dim to warm (3000K to 2200K) CCT Other CCT available upon request*	WL	
DIMMING	ZT 0-10V dimming (120V only) PH Phase dimming DA DALI (220-240V only)	ZT	
FULL SKU		MIL03LVBKKBWLZT	

NOTES

* Specific CCT selection only available in 100K increments, from 2200K to 4000K inclusively. Not available with Dim-to-Warm feature.

TESTED DIMMER COMPATIBILITY LIST - 120V*

Phase cut dimming (leading edge or trailing edge**)

DIMMER BRAND	MODEL	MAX LEVEL	MIN LEVEL	DIMMING PROTOCOL
LUTRON	DVELV303P	100%	9%	Phase Cut
LUTRON	MAELV600	100%	3%	Phase Cut
LUTRON	SELV300P	100%	9%	Phase Cut
LUTRON	CTELV-303P	100%	5%	Phase Cut
LUTRON	CTRP-253P	100%	5%	Phase Cut
LUTRON	PD-5NE	100%	7%	Phase Cut
LUTRON	DVRP-253P	100%	5%	Phase Cut
LUTRON	MA-PRO	100%	6%	Phase Cut
LUTRON	NTRP-250	100%	8%	Phase Cut
LUTRON	NTELV-300	100%	9%	Phase Cut

TESTED DIMMER COMPATIBILITY LIST - 230V*

Phase cut dimming (leading edge or trailing edge**)

DIMMER BRAND	MODEL	MAX LEVEL	MIN LEVEL	DIMMING PROTOCOL
CLIPSAL	32E450TM	100%	25%	Phase Cut
CLIPSAL	32E450UDM	100%	31 %	Phase Cut

*Other dimmers can yield good results and we recommend conducting your own test before final installation.

Some dimmers require a minimum load, check specifications.

*Other dimmers that specify LED lamp compatibility may operate without issue.

We recommend conducting your own test before final installation.

**Leading edge is also known as TRIAC or Forward Phase.

Trailing edge is also known as ELV or Reverse Phase.
