

mdf italia



© COPYRIGHT 2023 MDF ITALIA SRL SOCIETA' UNIPERSONALE

2009 - 2019

TENSE

Designed by Piergiorgio Cazzaniga, Michele Cazzaniga

“To design by simplifying, to extrapolate the essence”.

This was the genesis of Tense by Piergiorgio and Michele Cazzaniga. Tense represents the core, the primary concept of the table idea, so unique and minimal to adapt to many different spaces, both residential and contract.

Tense is the table's soul, that expresses itself through a huge consistency in terms of shapes and finishes, the latter in a single material and identical for legs and top, sending a sensation of compactness and modernity. In its essentiality, this table hides a technological heart, encased in the top's panel, which enables, thanks to the internal tension, to achieve big dimensions, up to 4 meters. And, thanks to the minimum thickness of the top, Tense keeps in any case a high lightweight and stability. The possibility of coming in different sizes and colours enables Tense to meet every customer's need. Equipped with top-access, the table also lends itself to the needs of professional spaces.

In 2019, to celebrate the 10th anniversary of the Tense table, MDF Italia introduces NEW SIZES AND FOUR NEW HEIGHTS (H35, H45, H90, H110 cm). So, a real table system was created, divided into 5 categories according to five heights, in order to meet different market needs: low table, coffee table/bench, dining table/working table, console/high table/high working table, high table bar/office.

WHY TENSE:

- A lightweight and technological table
- Available in three colours
- Developed in 5 heights (H35, H45, H73, H90, H110) and 36 sizes
- Available the equipped version with 1 or 2 top-access and under top cable tray
- Recommended for both residential and contract spaces

[EXPLORE THE WHOLE TENSE COLLECTION](#)

FRAME AND TABLETOPS

The table is available in the following versions:

- matt white, made of acrylic resin and rock minerals. Tabletop, edges and legs covered with a 3mm thick sheet of resin.

- matt black and medium grey acrylic resin and FENIX high-pressure stratified laminate of the latest generation.

Tabletop in stratified laminate with mass colouration; edges and legs in acrylic resin and rock minerals.

35 mm thick tabletop. 35x35 mm steel legs with internal structural tie.

TOP-ACCESS

The table is also available in a version equipped with 1 or 2 top-access and an under top cable tray.

The top-access, in size 127x350 mm, are in aluminium.

Finishes: matt white lacquer with tables in matt white, or matt black lacquer with tables in black and medium grey.

TENSE

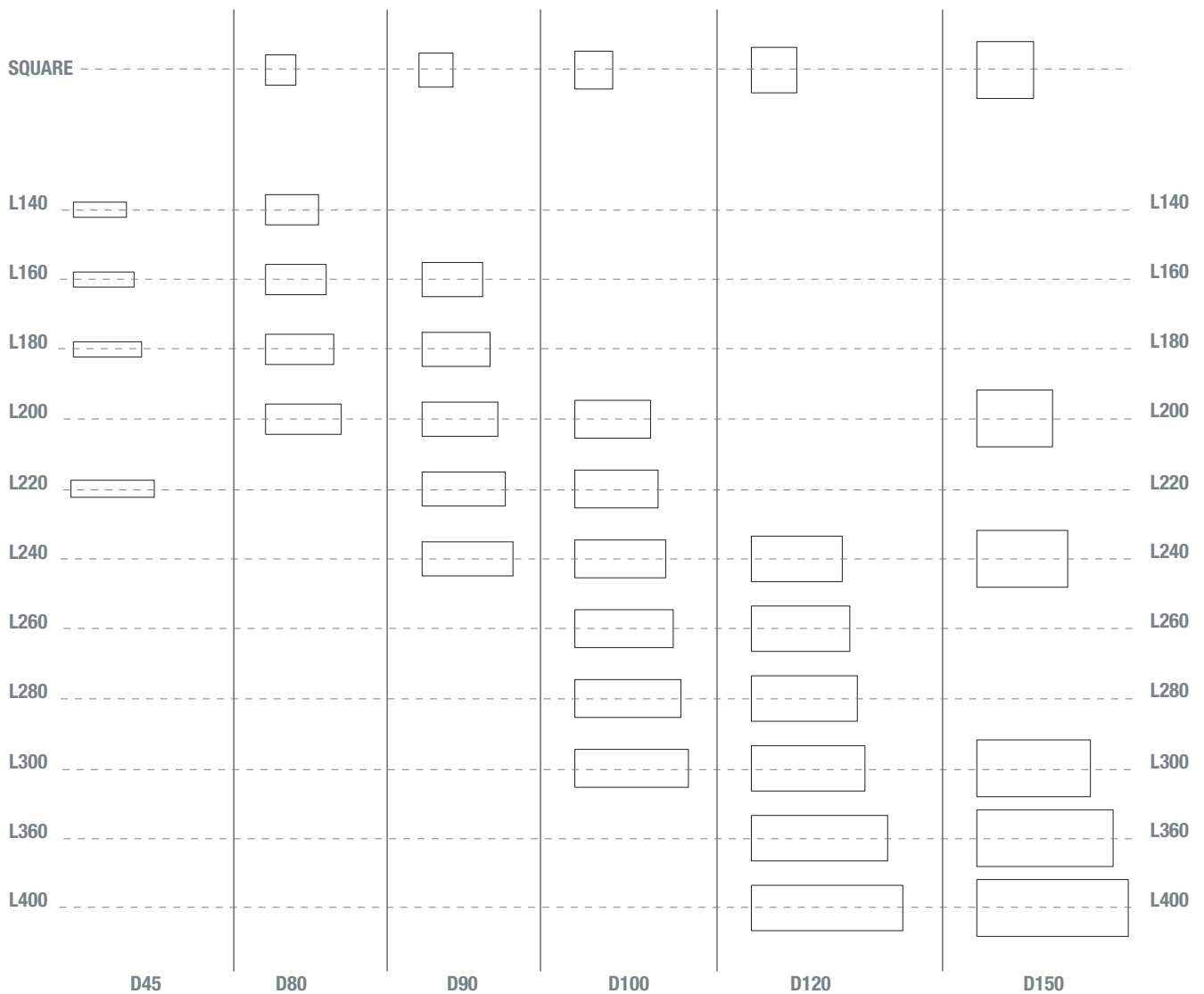
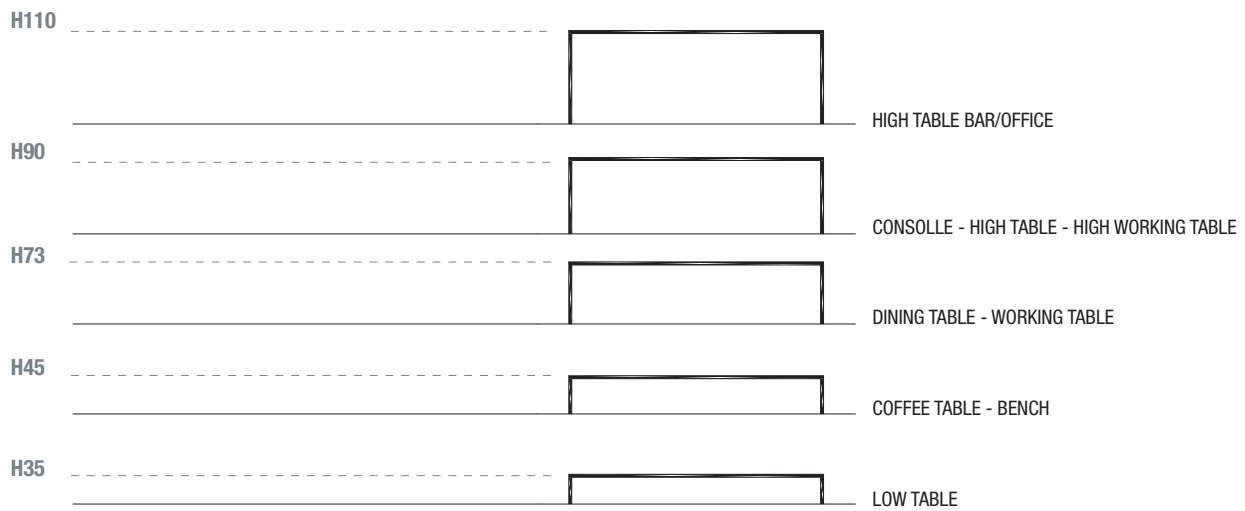

TYPE OF TOP-ACCESS L35 X H12.7 CM

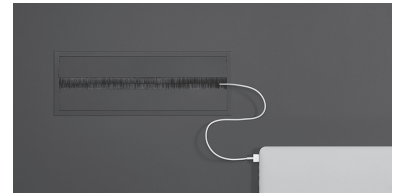
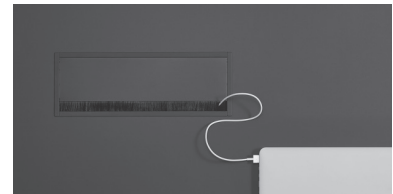
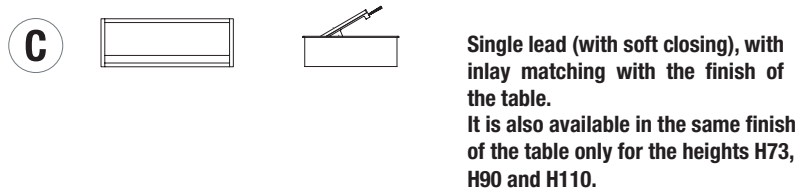
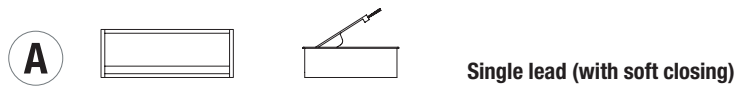

TYPE OF METAL WIREWAY (TELESCOPIC)

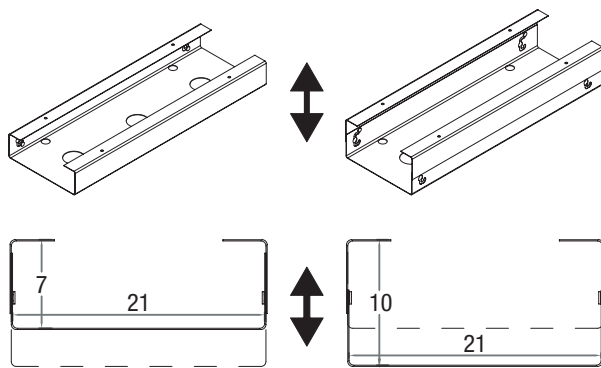

The metal cable trays are telescopic (H7/10 cm).

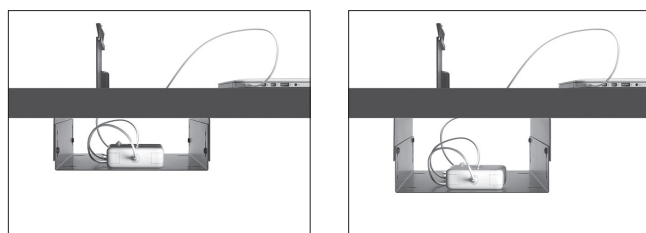

POSITION OF THE TOP-ACCESS

With one or two lateral top-access

X (cm)	Y (cm)
90	160
90	180
90	200
90	220
100	200
100	220

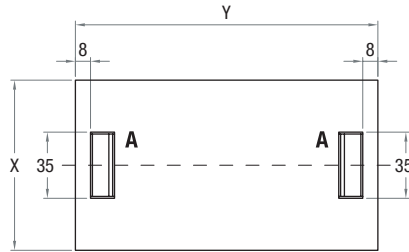

With one central top-access

X (cm)	Y (cm)
150	150
150	200
150	240

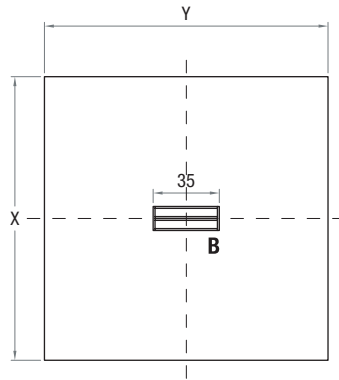

With two front top-access

X (cm)	Y (cm)	L (cm)
90	240	52
100	240	52
100	260	64
100	280	84
100	300	104
120	240	52
120	260	64
120	280	84
120	300	104
120	360	164
120	400	116

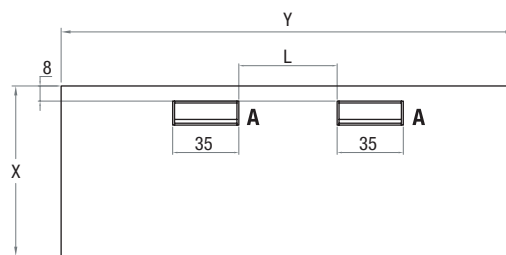

With two central top-access

X (cm)	Y (cm)	L (cm)
120	240	52
120	260	64
120	280	84
120	300	104
120	360	164
120	400	116
150	300	104
150	360	164
150	400	116

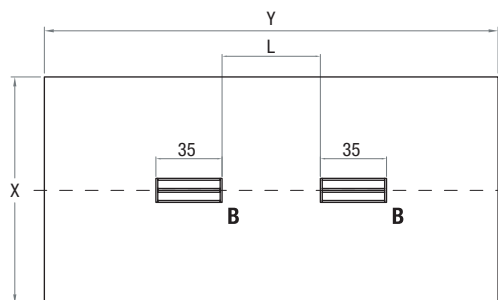

EXAMPLE OF TOP-ACCESS AND METAL WIREWAY POSITION

With one or two lateral top-access

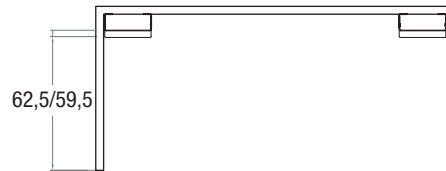
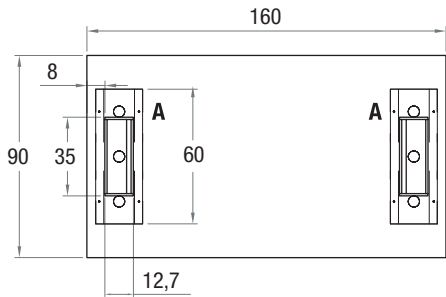

With two front top-access

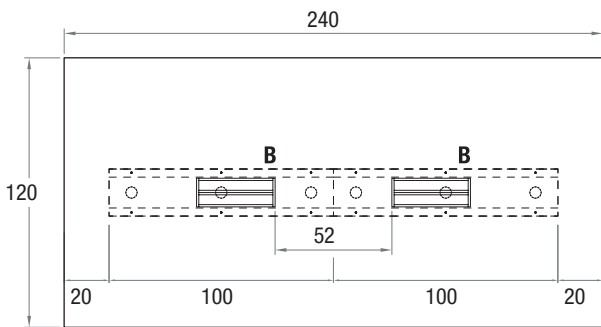

Finishing

The number in the dot corresponds to the number of colour/material finish.

Here below, in the section FINISH OPTIONS, please note all the colours of the materials used for this product.

TABLE

Top/Structure

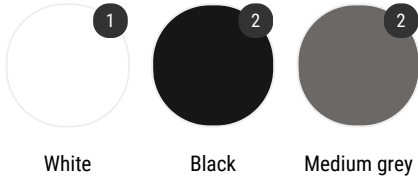

Finish options

TOP/STRUCTURE

White



White solid
surface X035

Black

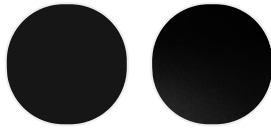

Top in Fenix
matt black
X022

Structure in
matt black
resin

Medium grey



Top in Fenix
matt medium
grey X021

Structure in
matt medium
grey resin