



DOT WALL



type	wall	
materials	body :	brass (BR) or powdercoated steel and aluminium (BL/WH)
	sphere :	milk glass (G50)
	wire :	vinyl
wire length (softwire)	96" / 2438 mm switch positionned at 18"/457 mm from body	
weight	1.5 lb / 0.7 kg	
light bulb	LED (included), 3,5W	
sockets	G9	
voltage	120V / 240V	
dimmer	For hardwire installation only refer to our recommended list of dimmer models	
certifications	 	
notes	<ul style="list-style-type: none"> - must be installed by an electrician - lead time between 7-9 weeks - dimensions are approximate and may vary slightly 	

HARDWIRE

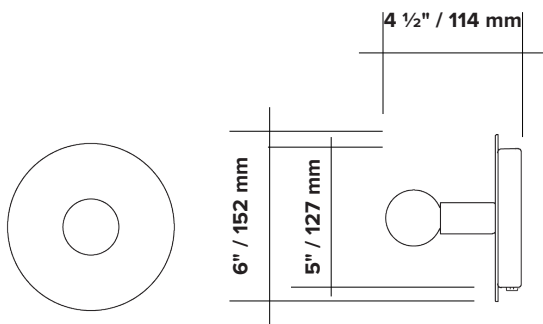

SOFTWIRE

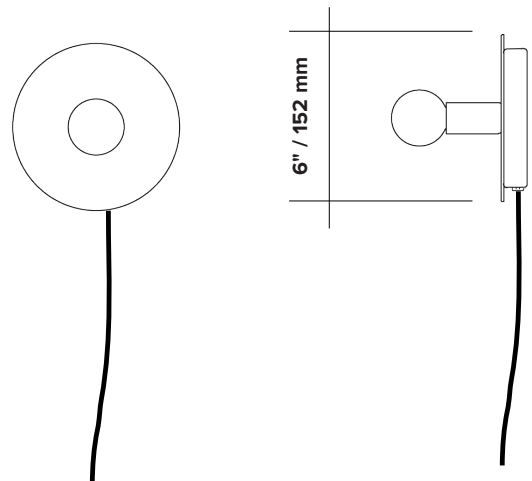

ORDER GUIDE: SKU

<u>COLLECTION</u>	<u>MODEL</u>	<u>FINISH</u>	<u>INSTALLATION</u>	
DOT dot	03	BR brass BL black WH white	HW hardwire SW softwire	
DOT	03	BR	HW	= DOT03BRHW example

FINISH



brass

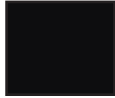

flat black



flat white

HARDWIRE

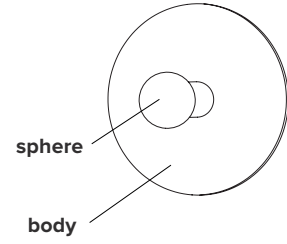

SOFTWIRE

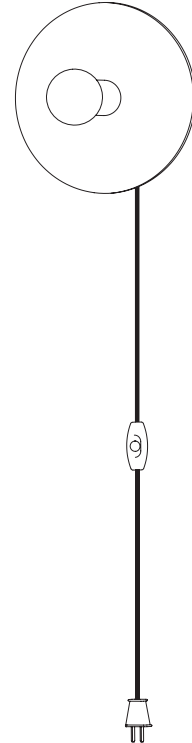

LIGHT BULB & DIMMER SPECIFICATIONS

G9 SOCKETS

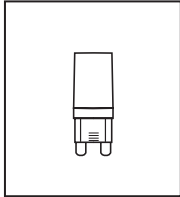

Frosted
3.5W
100V-120V / 240V
350 Lumens
2700 K
25 000 H
CRI ≥80
2 years warranty

SPHERES



G50 $\varnothing \pm 2" / 50 \text{ mm}$



DIMMER LIST COMPATIBILITY FOR G9 LED BULBS – 120V

The dimming technology offering the best results is ELV (electronic low voltage) dimmers with reverse phase or trailing edge control.

<u>DIMMER BRAND</u>	<u>MODEL NUMBER</u>	<u>MAX LEVEL</u>	<u>MIN LEVEL</u>	<u>FLICKERING</u>	<u>OVERALL QUOTE</u>
LUTRON - MAESTRO	MAELV-600	100%	0%	0%-10%	good
LUTRON - SKYLARK	SELV-300P	100%	0%	no	very good
LUTRON - SKYLARK	SELV-303P	100%	0%	no	very good
LUTRON - SKYLARK	CTELV-303P	100%	0%	no	very good
LUTRON - DIVA	DVELV-300P	100%	0%	no	very good
LEGRAND - ADORNE	TRUE UNIVERSAL	100%	30%	no	good

DIMMER LIST COMPATIBILITY FOR G9 LED BULBS – 230V

<u>DIMMER BRAND</u>	<u>MODEL NUMBER</u>	<u>MAX LEVEL</u>	<u>MIN LEVEL</u>	<u>FLICKERING</u>	<u>OVERALL QUOTE</u>
VARILIGHT	V-PRO	100%	2%	no	very good
LEGRAND - NILOÉ	3 996 35	87%	15%	no	good
NIKO	310-0280X	94%	5%	no	very good
NIKO	310-0190X	100%	1%	no	very good

*Other dimmers can yield good results and we recommend conducting your own test before final installation.