

Winter Holiday Cards eBook

Paper Circuits Projects



BROWN DOG *Gadgets*

BrownDogGadgets.com

Winter Holiday Cards eBook

Paper Circuits Projects

Each of the cards in this eBook can be made using Maker Tape and 10mm Jumbo LEDs, which can be found in our **Paper Circuits Kit**. Each card includes a ready-to-go full-color version as well as black & white version that can be colored by hand. Print each card as a double sided print and then cut them out with scissors.

Guides for each of these projects (and many more!) can be found at learn.BrownDogGadgets.com



Christmas Tree

Color: Pages 3-4
Black & White: Pages 5-6
Time Required: 5-20 minutes



Nativity

Color: Pages 15-16
Black & White: Pages 17-18
Time Required: 5-20 minutes



Happy Hanukkah

Color: Pages 7-8
Black & White: Pages 9-10
Time Required: 5-20 minutes



Reindeer

Color: Pages 19-20
Black & White: Pages 21-22
Time Required: 5-20 minutes



Happy Kwanzaa

Color: Pages 11-12
Black & White: Pages 13-14
Time Required: 5-20 minutes



Nutcracker

Color: Pages 23-24
Black & White: Pages 25-26
Time Required: 5-20 minutes



Maker Tape

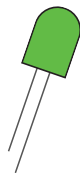

LED

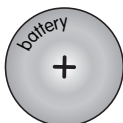

Battery



New to paper circuits? Check out our *Getting Started with Paper Circuits* video available at:

<https://youtu.be/BxOqugaHIZE>



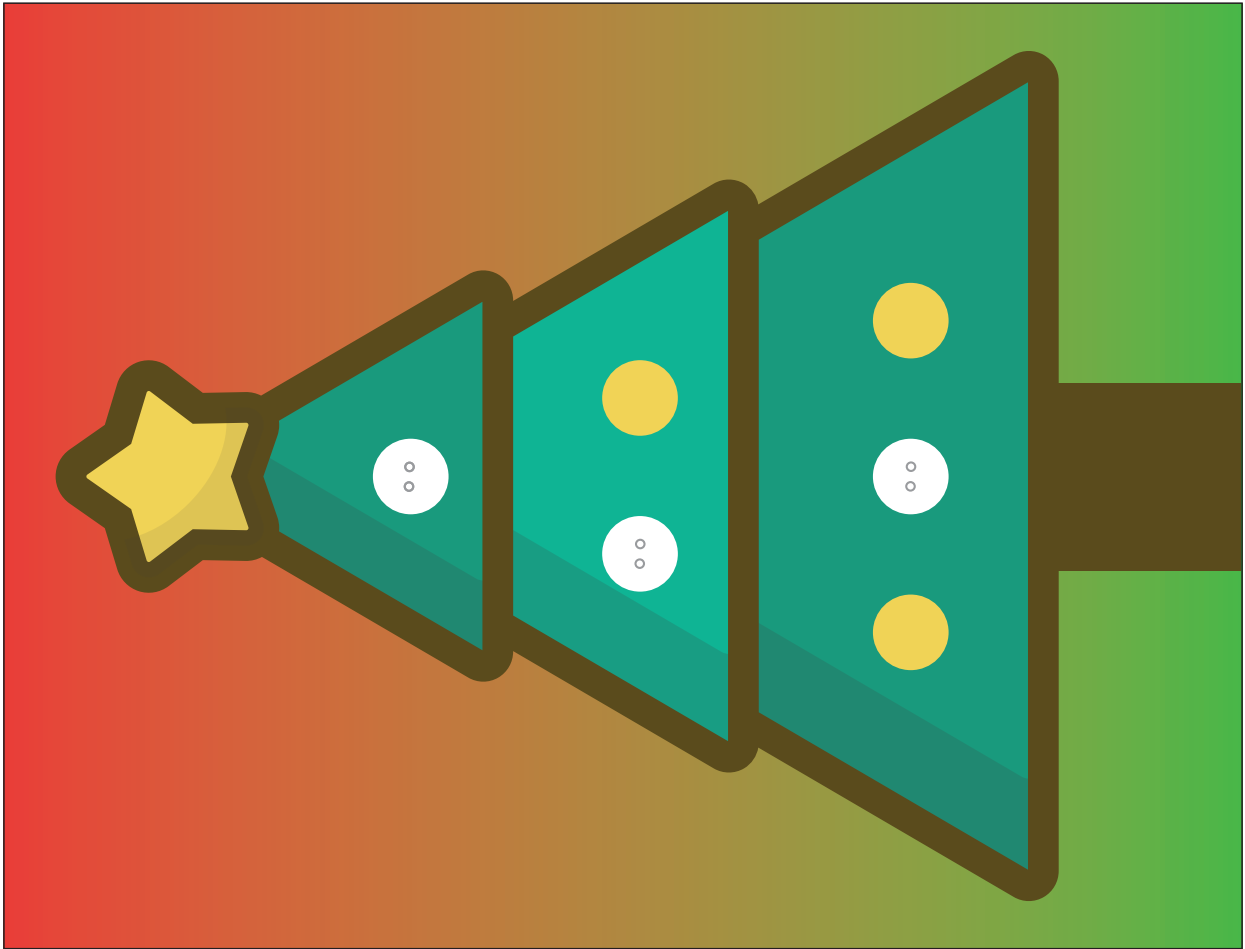

 For more free templates & fun project ideas visit us at BrownDogGadgets.com

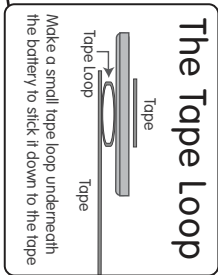
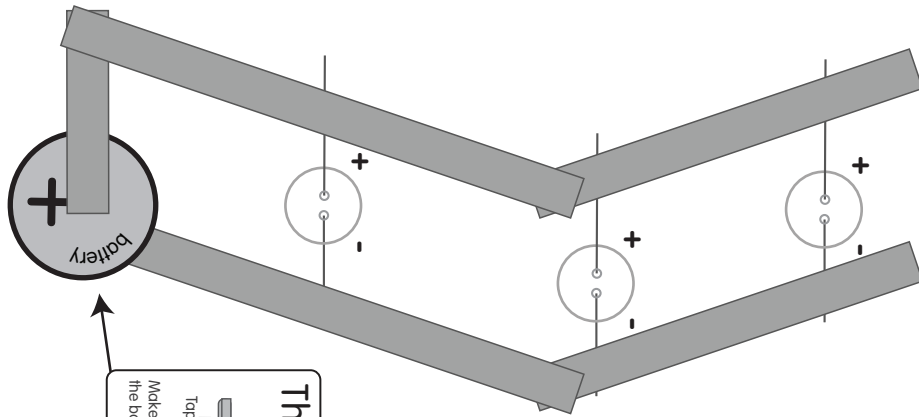

For more free templates and fun project ideas visit us at BrownDogGadgets.com



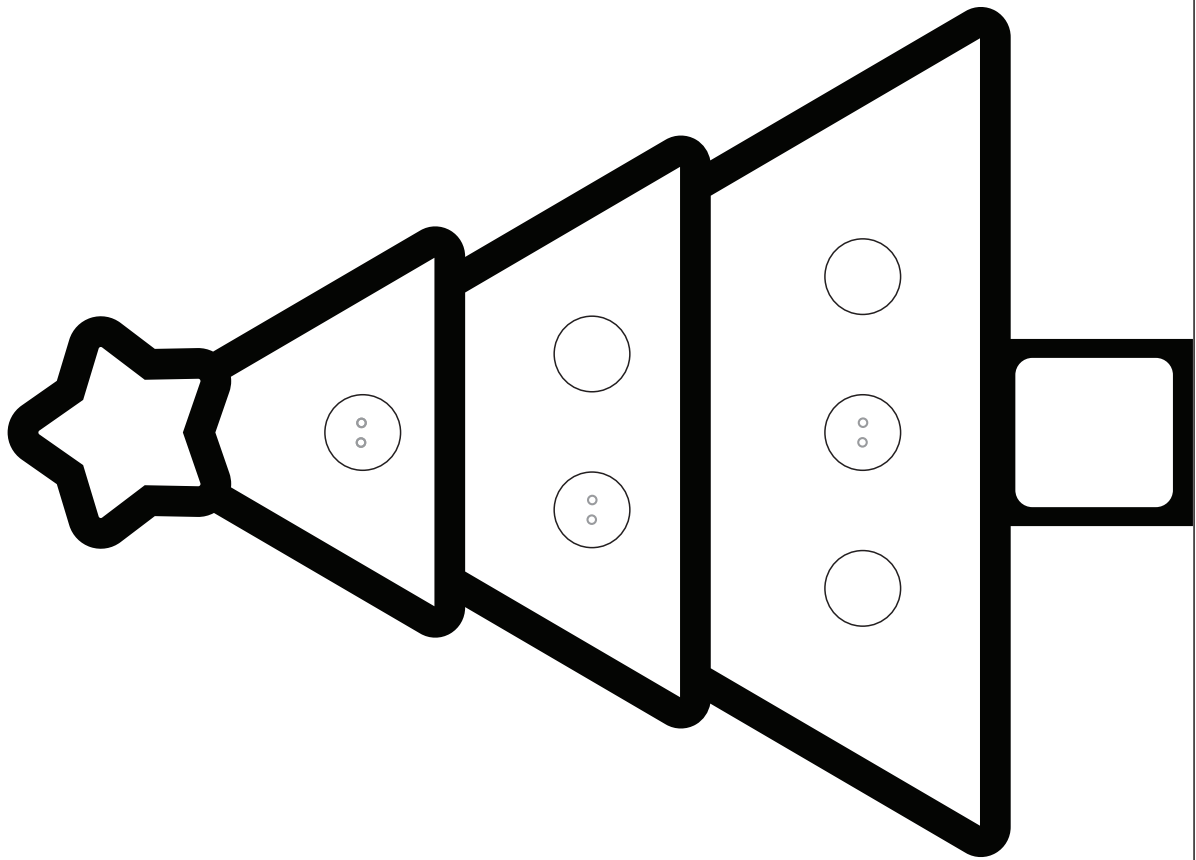

 For more free templates & fun project ideas visit us at BrownDogGadgets.com

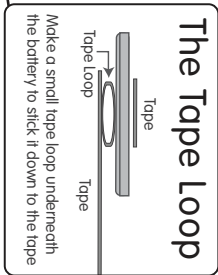
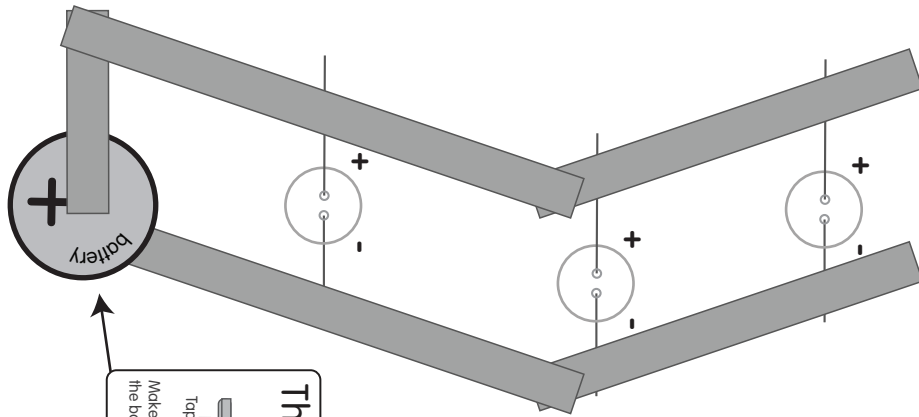

For more free templates and fun project ideas visit us at BrownDogGadgets.com





 For more free templates & fun project ideas visit us at BrownDogGadgets.com

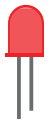
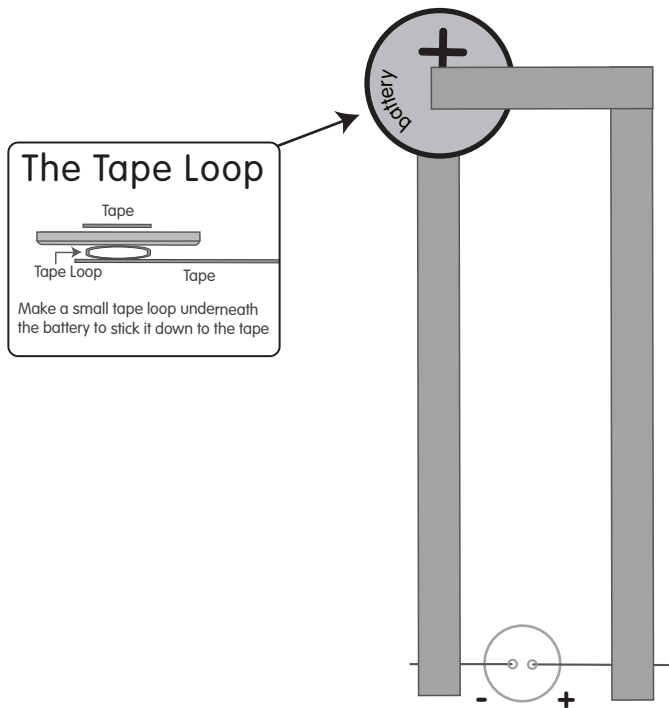

For more free templates and fun project ideas visit us at BrownDogGadgets.com



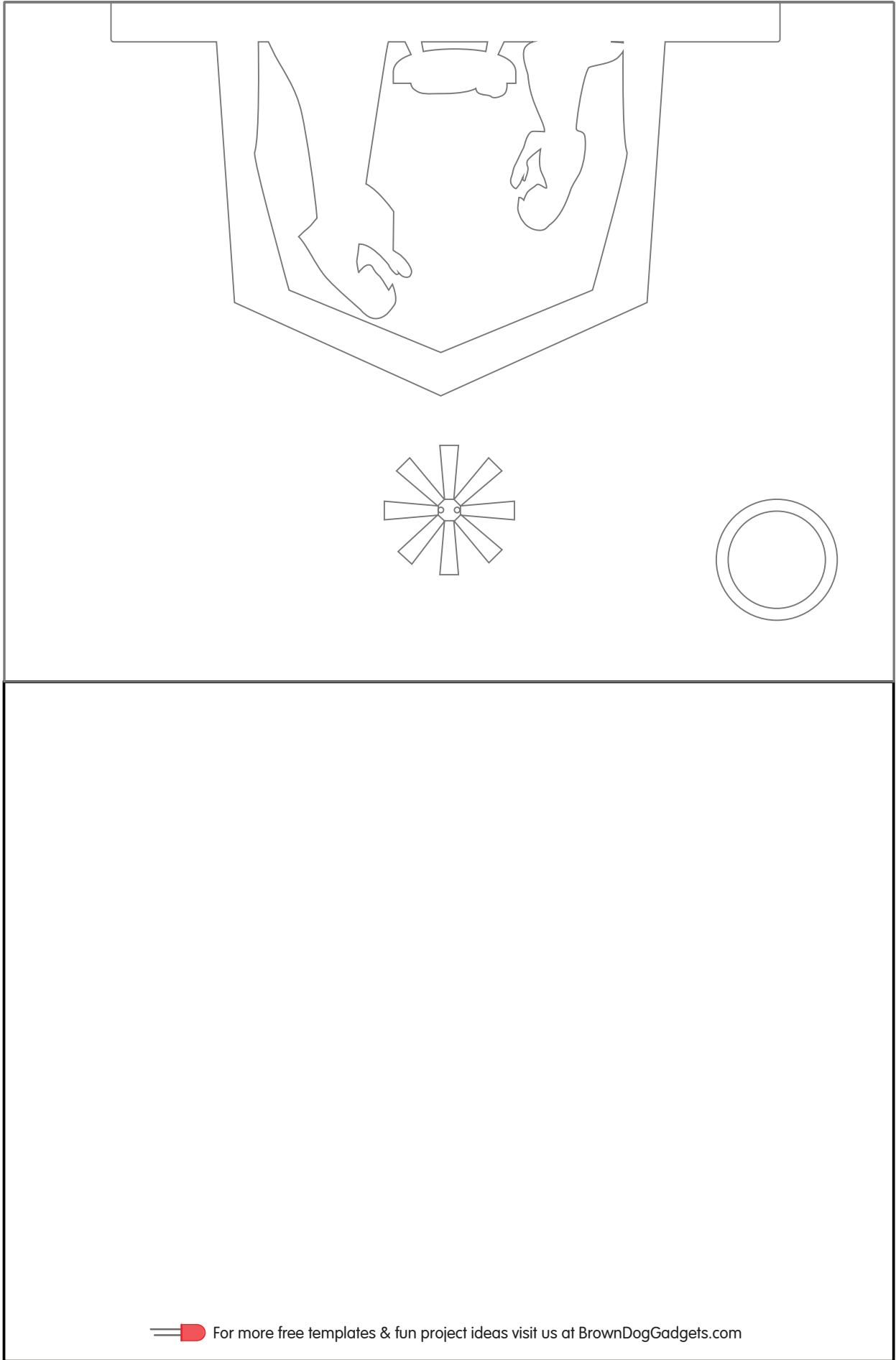

 For more free templates & fun project ideas visit us at BrownDogGadgets.com

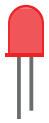
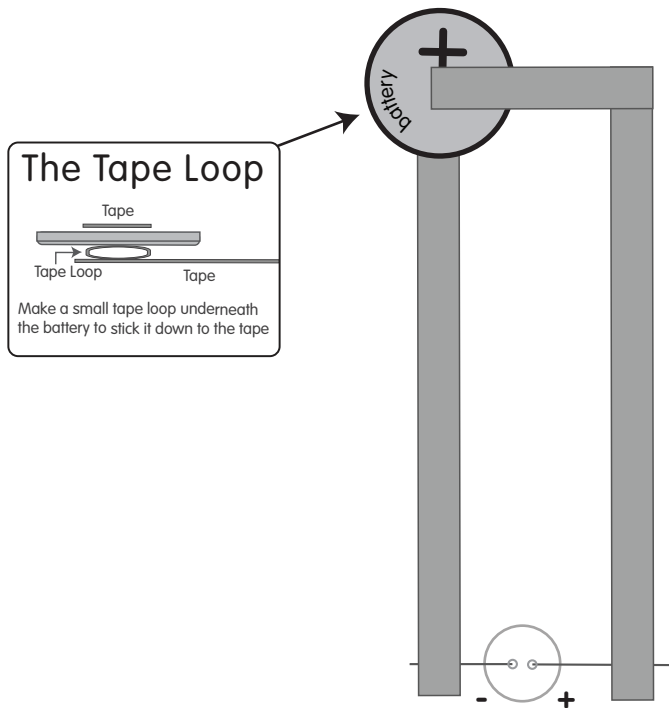

For more free templates and fun project ideas visit us at BrownDogGadgets.com



Happy Hanukkah

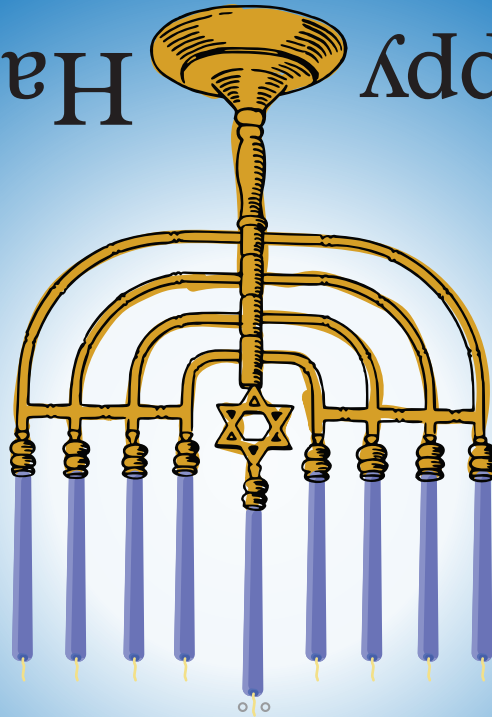

 For more free templates & fun project ideas visit us at BrownDogGadgets.com

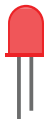
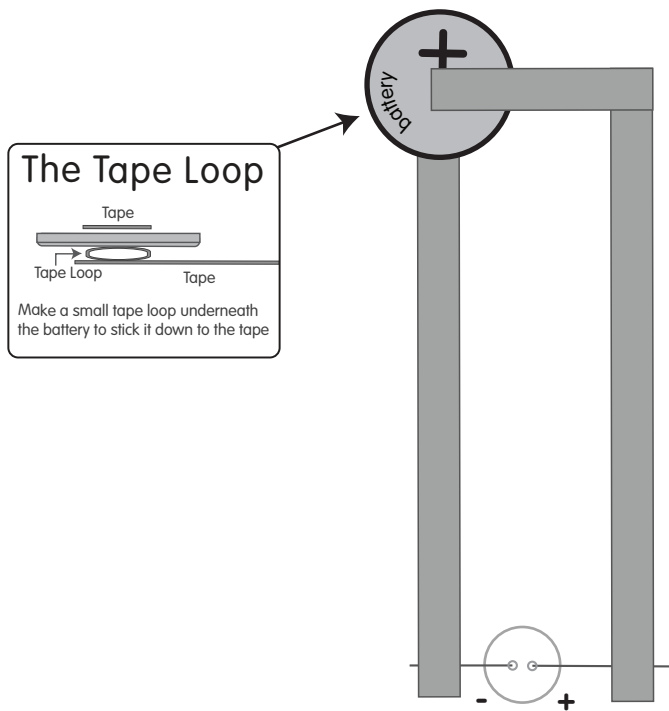

For more free templates and fun project ideas visit us at BrownDogGadgets.com



Happy Hanukkah

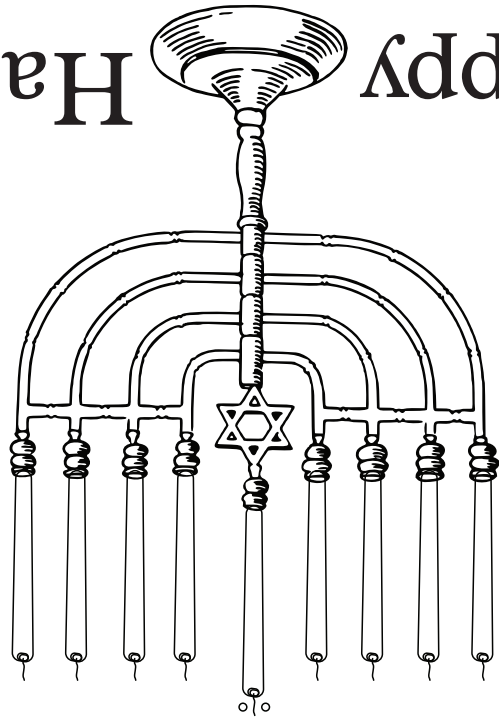
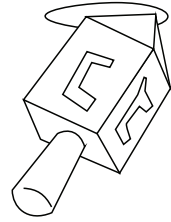

 For more free templates & fun project ideas visit us at BrownDogGadgets.com

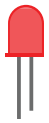
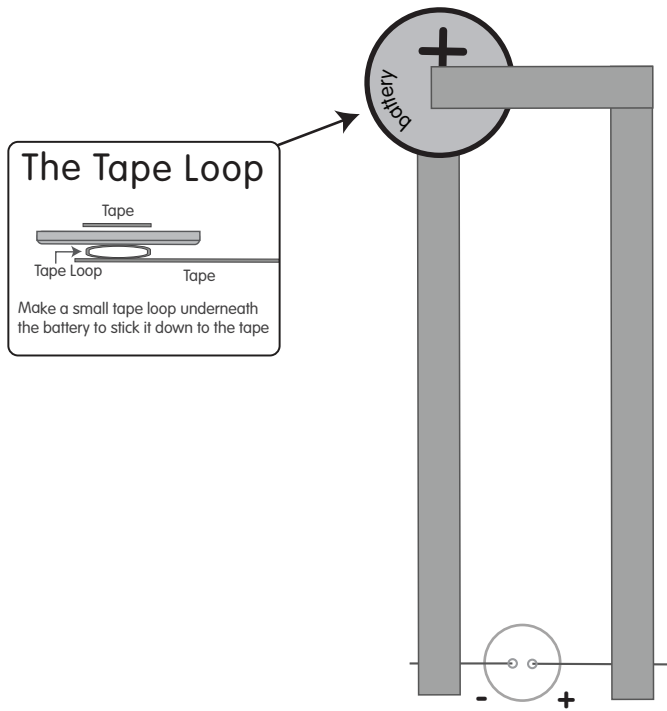

For more free templates and fun project ideas visit us at BrownDogGadgets.com



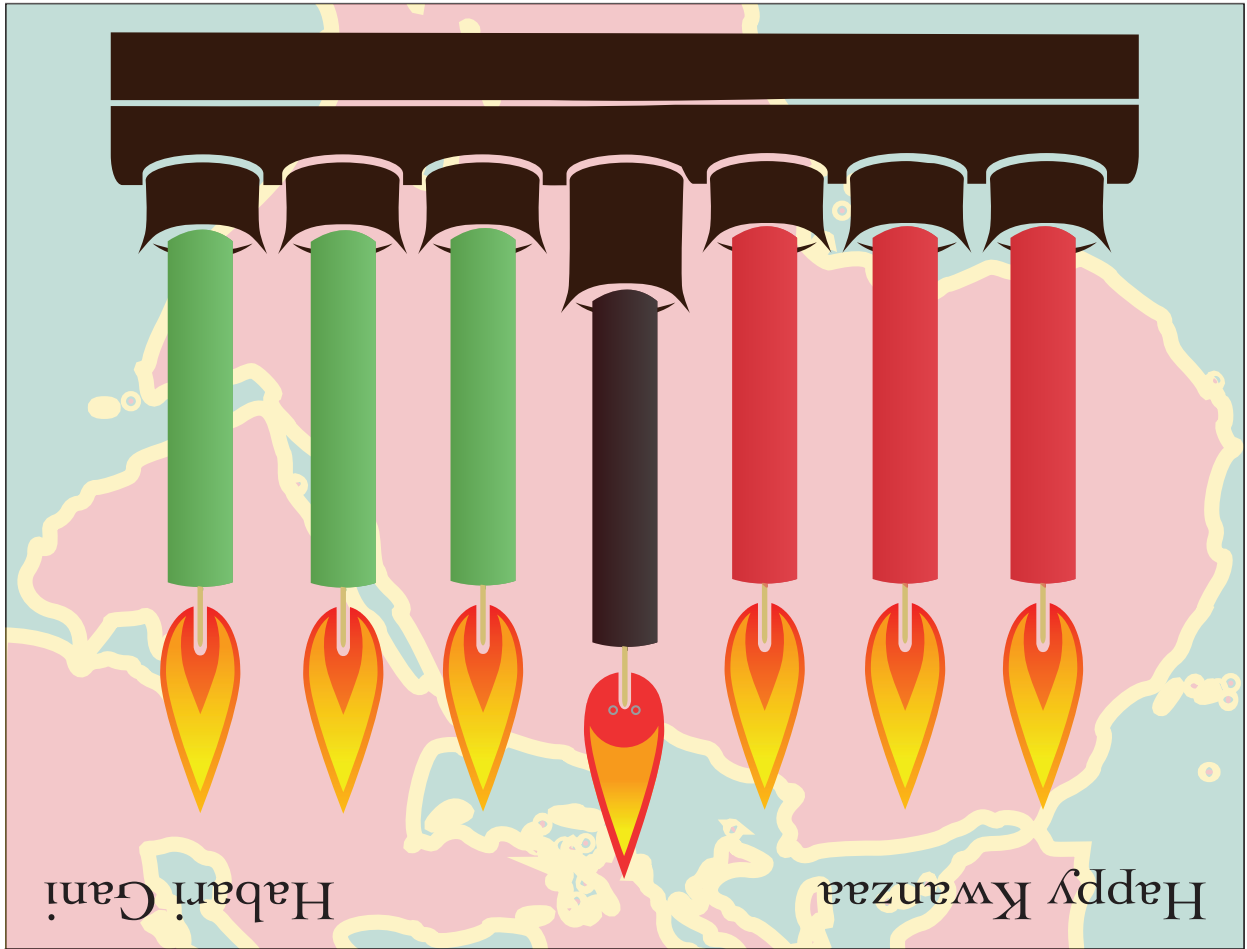

Habari Gani!

Happy Kwanzaa

 For more free templates & fun project ideas visit us at BrownDogGadgets.com

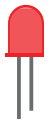
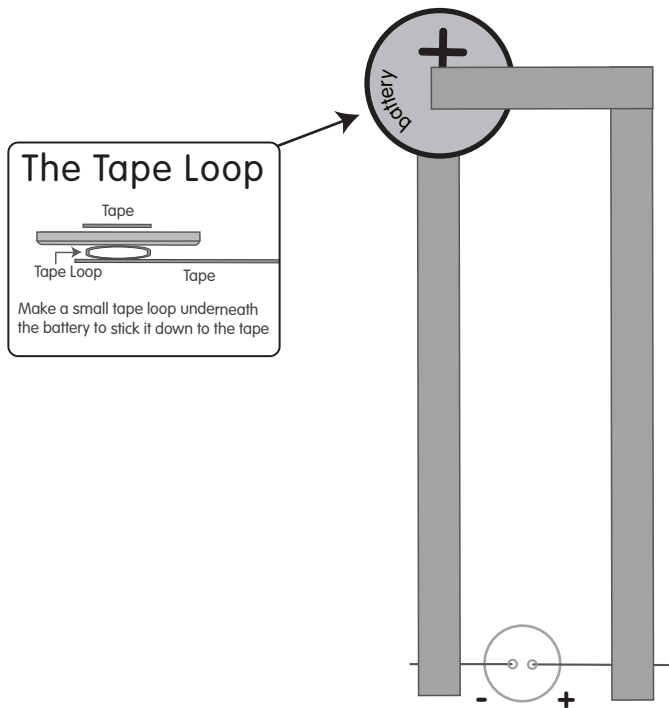

For more free templates and fun project ideas visit us at BrownDogGadgets.com



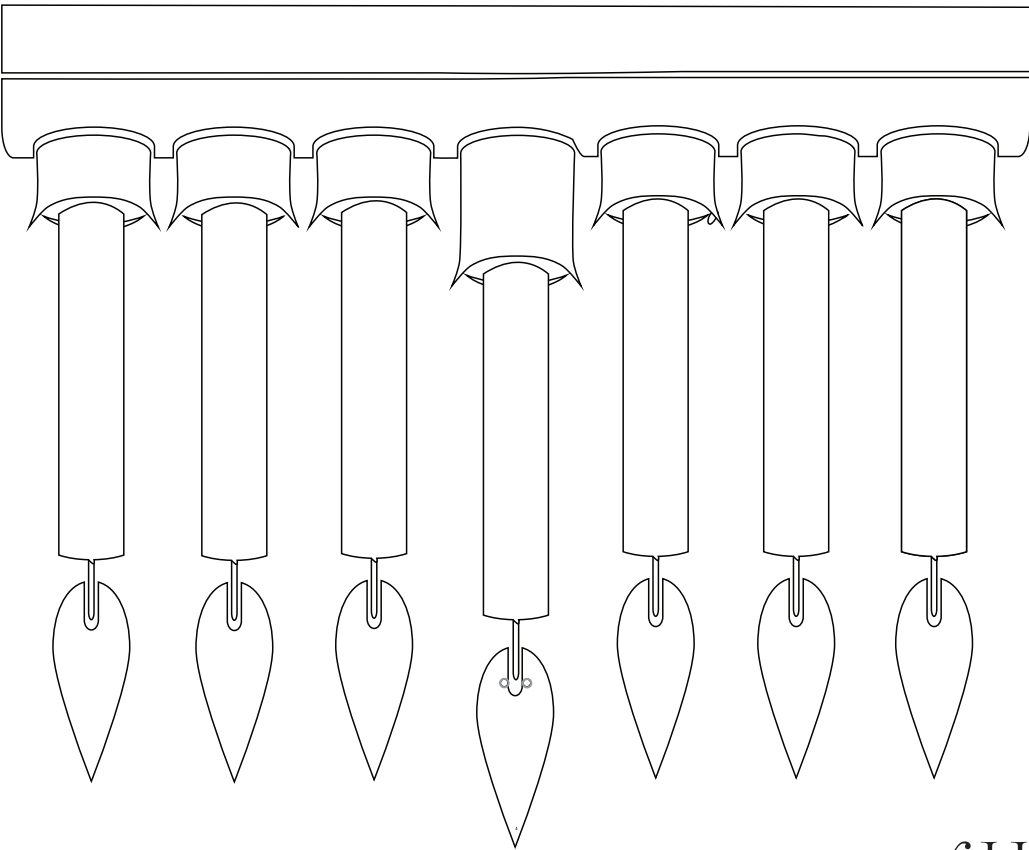

Habari Gani!

Happy Kwanzaa

 For more free templates & fun project ideas visit us at BrownDogGadgets.com

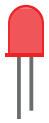
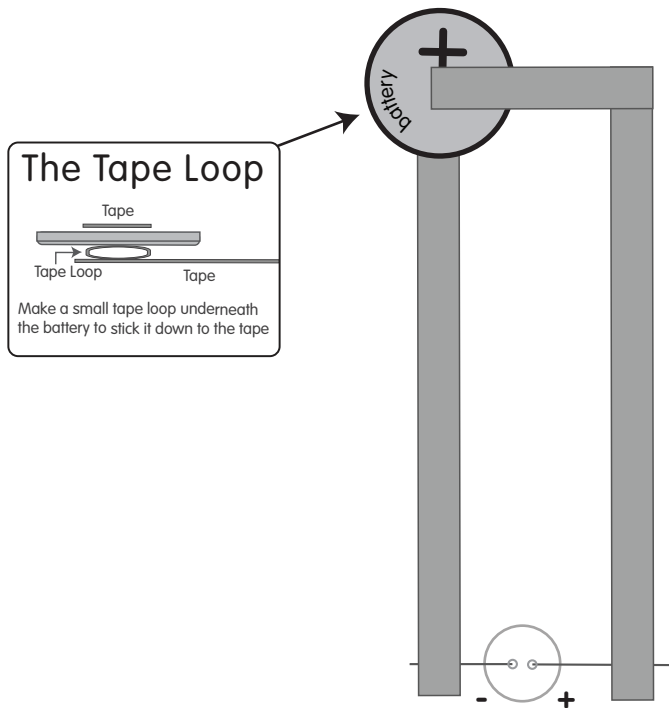

For more free templates and fun project ideas visit us at BrownDogGadgets.com





 For more free templates & fun project ideas visit us at BrownDogGadgets.com

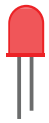
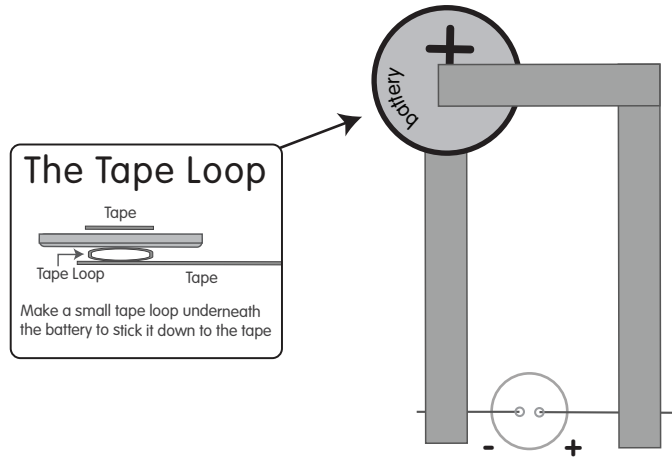

For more free templates and fun project ideas visit us at BrownDogGadgets.com



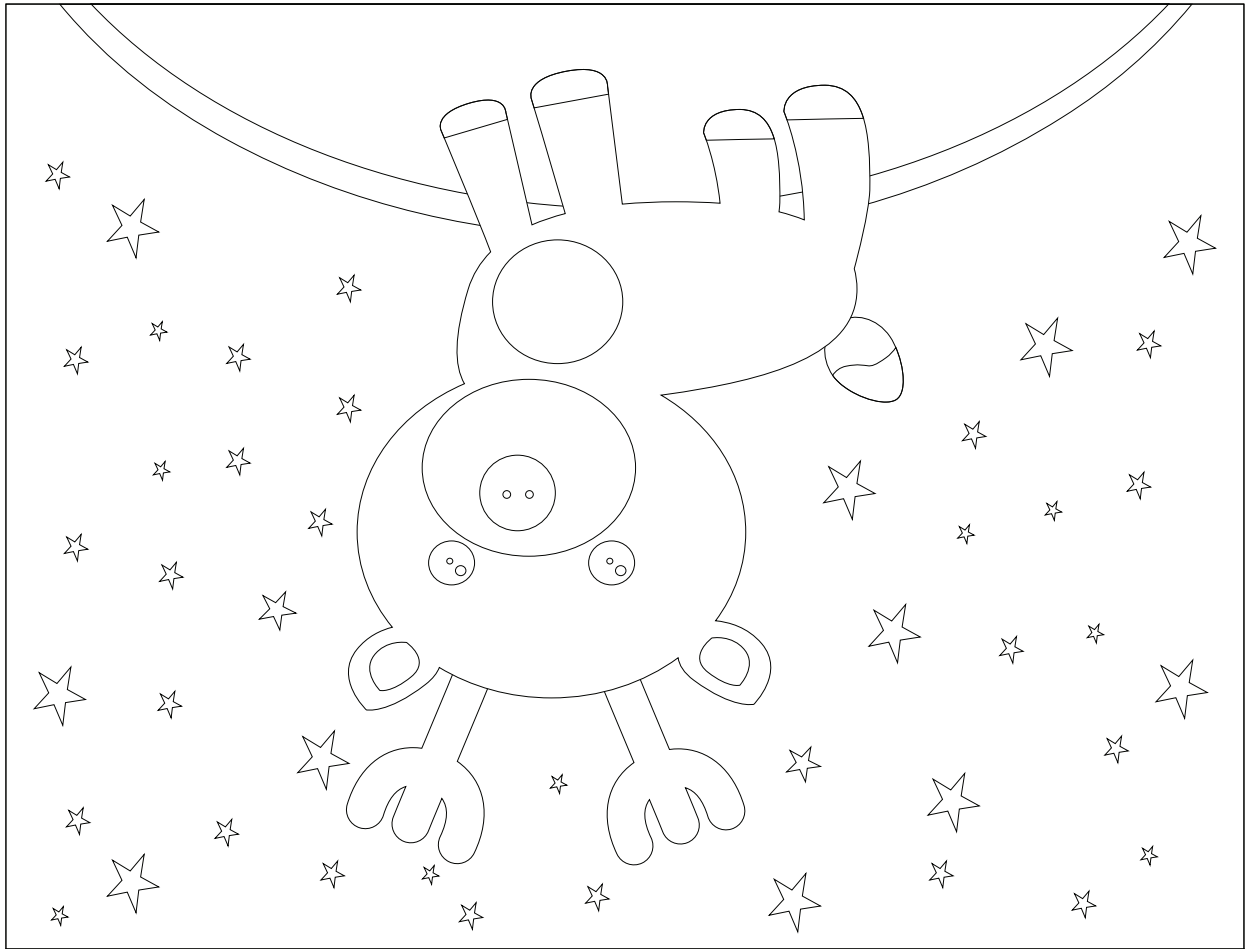

 For more free templates & fun project ideas visit us at BrownDogGadgets.com

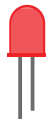
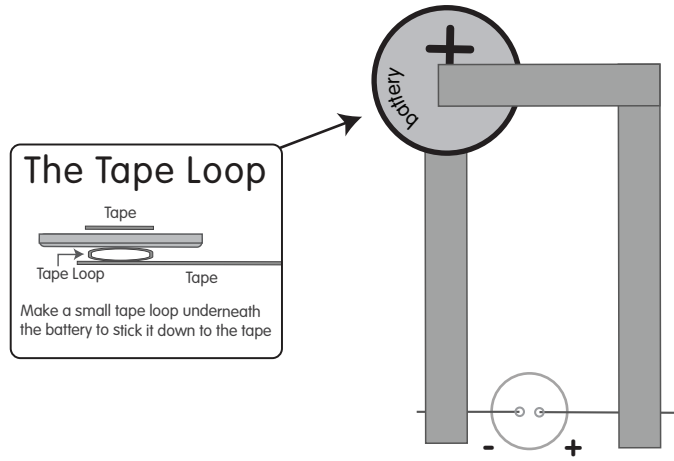

For more free templates and fun project ideas visit us at BrownDogGadgets.com



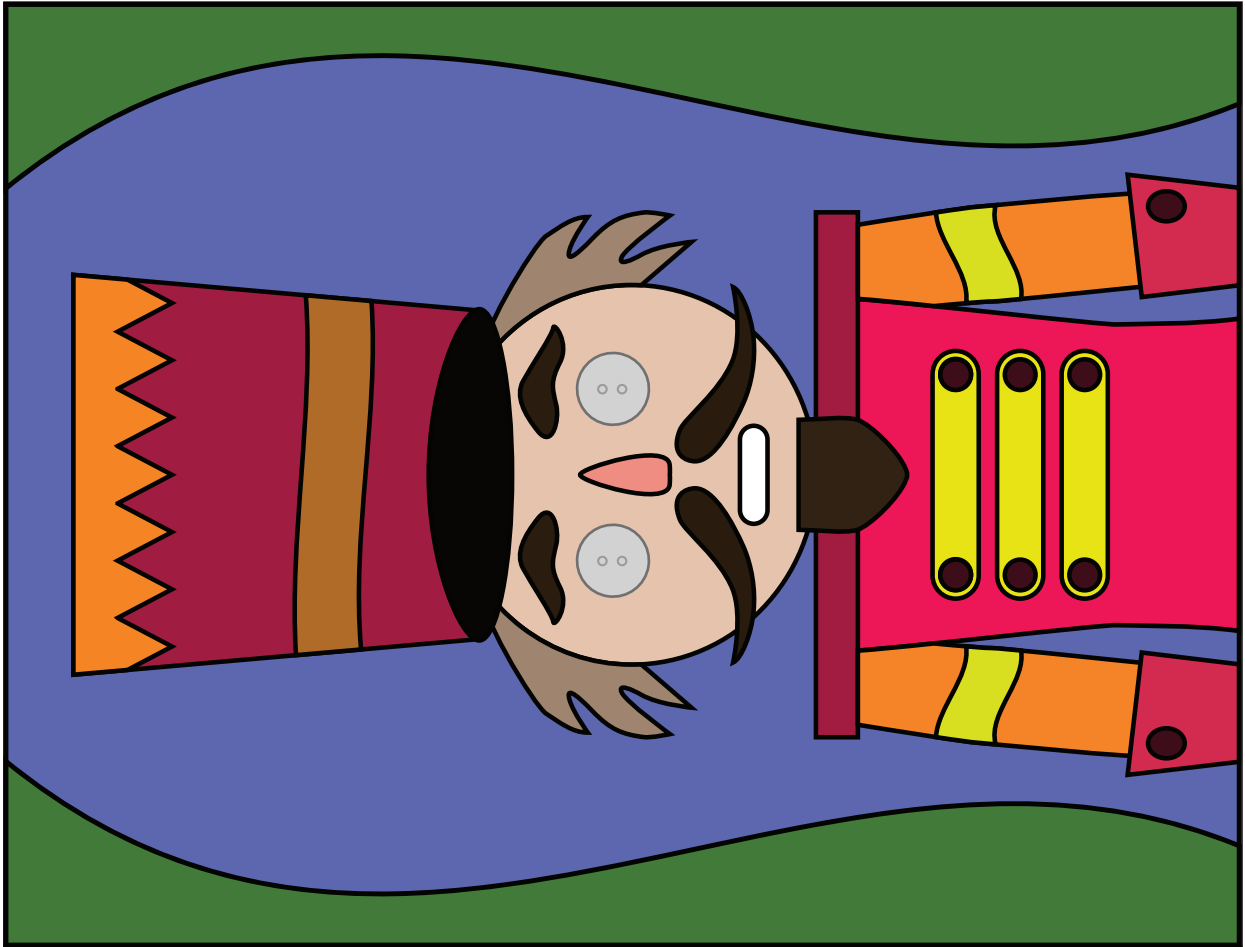

 For more free templates & fun project ideas visit us at BrownDogGadgets.com

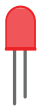

For more free templates & fun project ideas visit us at BrownDogGadgets.com

The Tape Loop

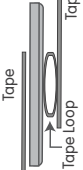

Make a small tape loop underneath the battery to stick it down to the tape.

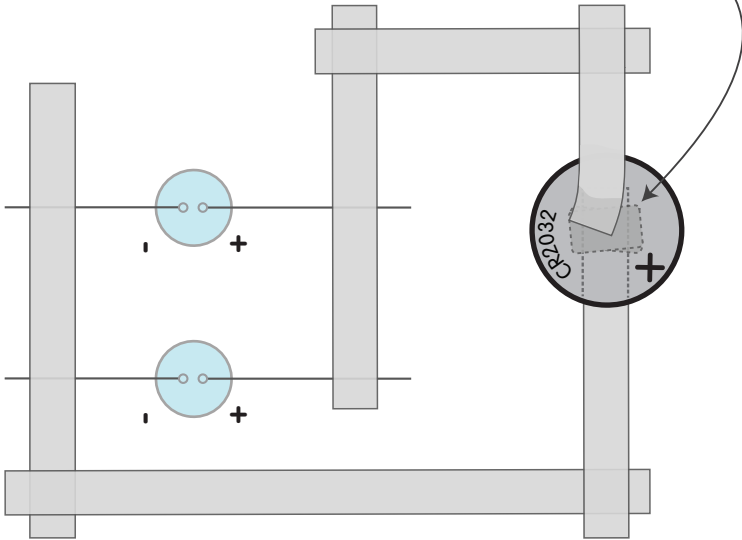

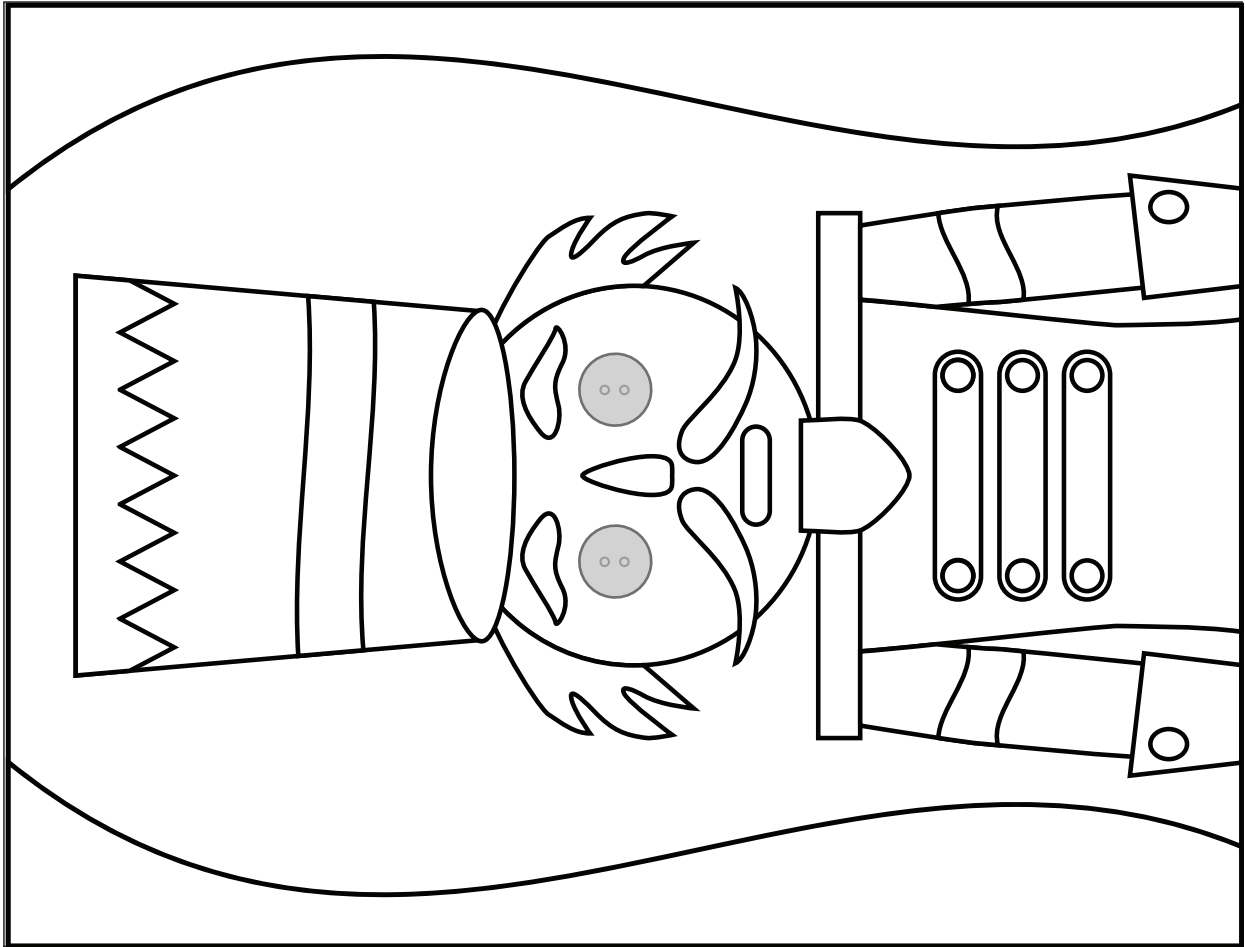

 For more free templates & fun project ideas visit us at BrownDogGadgets.com

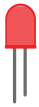

For more free templates & fun project ideas visit us at BrownDogGadgets.com

The Tape Loop

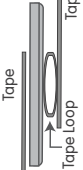

Make a small tape loop underneath the battery to stick it down to the tape.

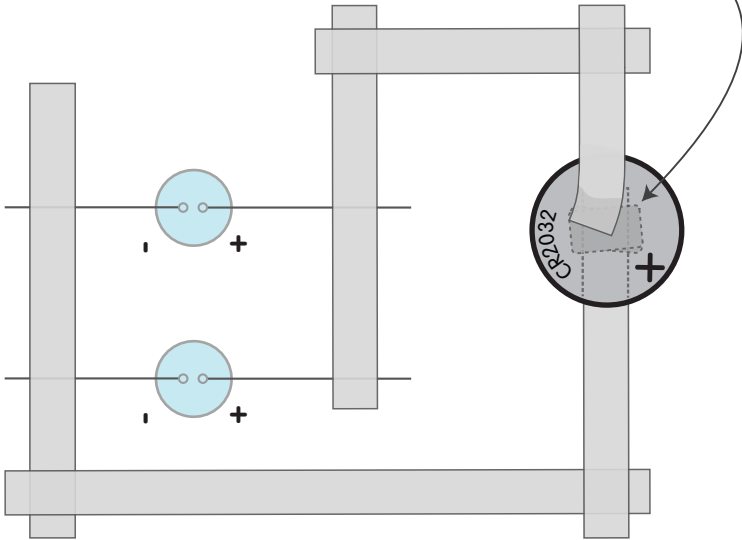



BROWN DOG *Gadgets*

Learn, Create, and Inspire—Even on a Budget

Creating a project from scratch can be difficult for the casual builder. Finding the right directions, the right parts, and the right tools—all at the right price—can be a major hurdle.

At Brown Dog Gadgets, we've created kits and projects for creators of all ages and budgets. Follow our step-by-step project directions and learn more with our classroom resources or find individual parts to dream up your own creations. No matter how or what you create, our products can help you learn the basics of electronics, circuitry, and solar energy.

Find additional eBooks, crafting guides, videos, directions, and educational resources at BrownDogGadgets.com. Contact us for educational discounts and free professional development classes.

help@browndoggadgets.com • 262-788-9223

BrownDogGadgets.com

