

LED Name Tags!

TIME:
5-10 MINUTES

YOU WILL NEED: _____

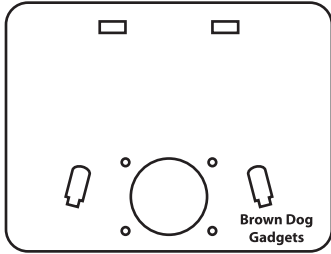

Blank
Acrylic Name Tag

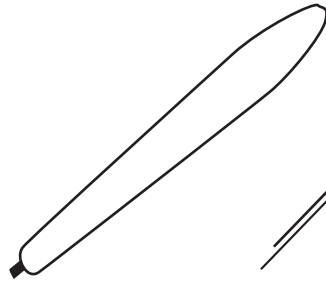

Dry Erase
Marker

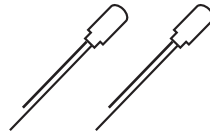

2 LEDs

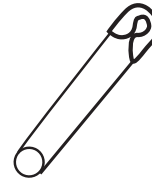

Safety Pin

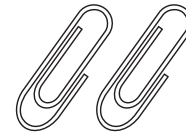

2 Paper Clips



Battery

- 1** DRAW YOUR NAME or DESIGN **2** ETCH YOUR NAME or DESIGN

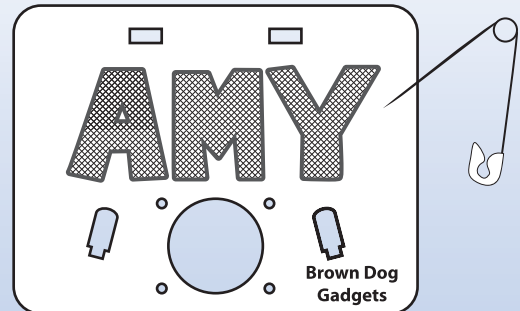
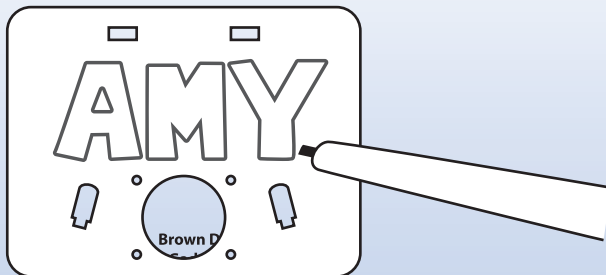

- 3** PEEL PAPER BACKING OFF **4** INSERT FIRST LED into LEFT SIDE

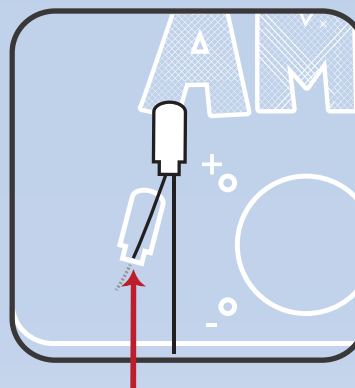
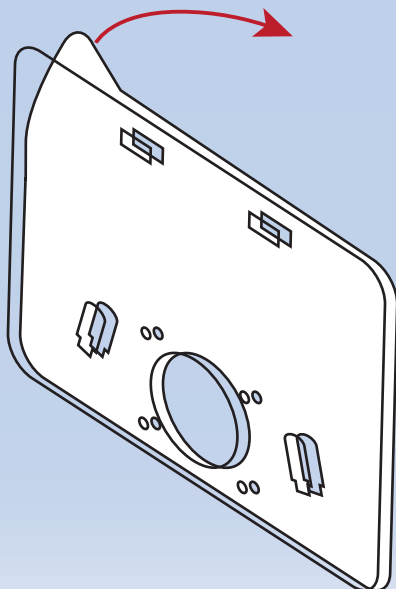

Insert short leg
through the hole

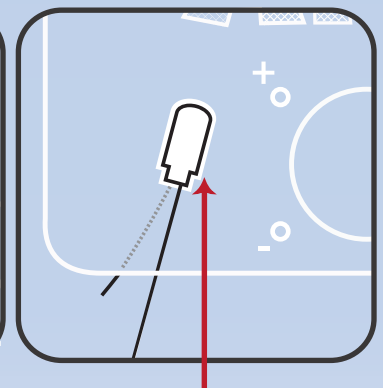

Pop LED into place

Please visit www.BrownDogGadgets.com for more great ideas & info.

5 ADD PAPERCLIP

Slip paper clip over the leg

Push the 1/4 of the leg through the "+" hole

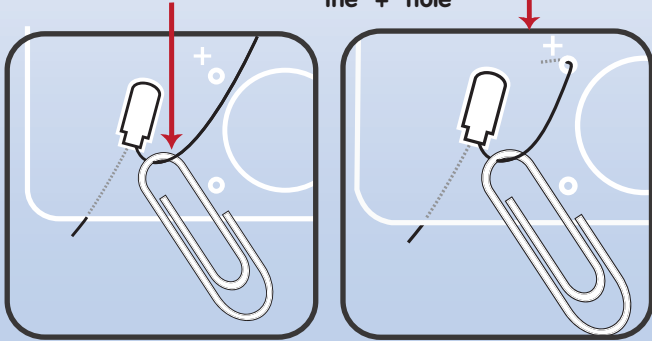

6 INSERT SECOND LED into RIGHT SIDE

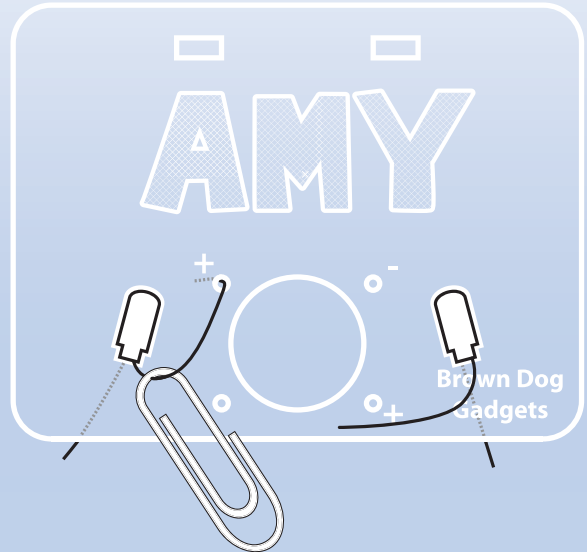

7 HOOK SAME PAPERCLIP

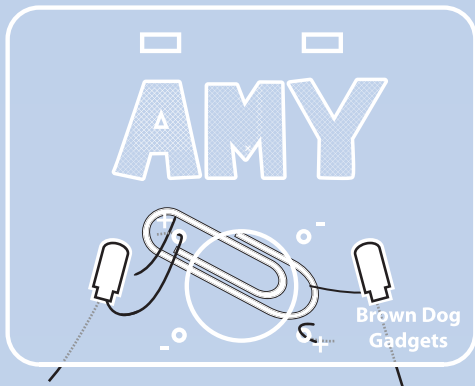

8 FLIP NAME TAG OVER.

Do the **SAME PAPERCLIP PROCESS** with the **NEGATIVE LEGS** on the **BACK** of the **TAG**.

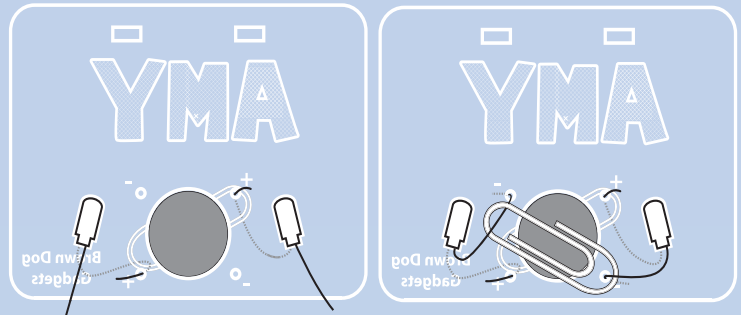

? What if it doesn't light up?

- Your LED legs may have broken from all the twisting. Get a new one.
- Your battery or an LED may be backwards. Switch them.
- Your paperclip isn't making good contact on one side.
Remove the LED legs from the holes and push out the paperclip center a bit to make it more springy.

9 ADD SAFETY PIN

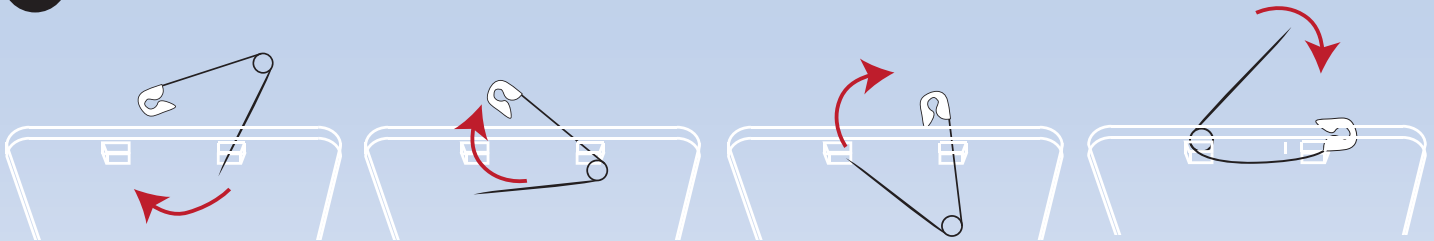

WELL DONE:
YOU BUILT A LIGHT-UP NAME TAG!

Please visit www.BrownDogGadgets.com for more great ideas & info.