



# MILCASA

S T O R E

**DIVA**  
**FLUID**

New Patented sliding system equipped with next generation Fluid soft-closing technology.  
Nuovo sistema di scorrevoli brevettato con fermi ammortizzati dotati della tecnologia di ultima generazione Fluid.

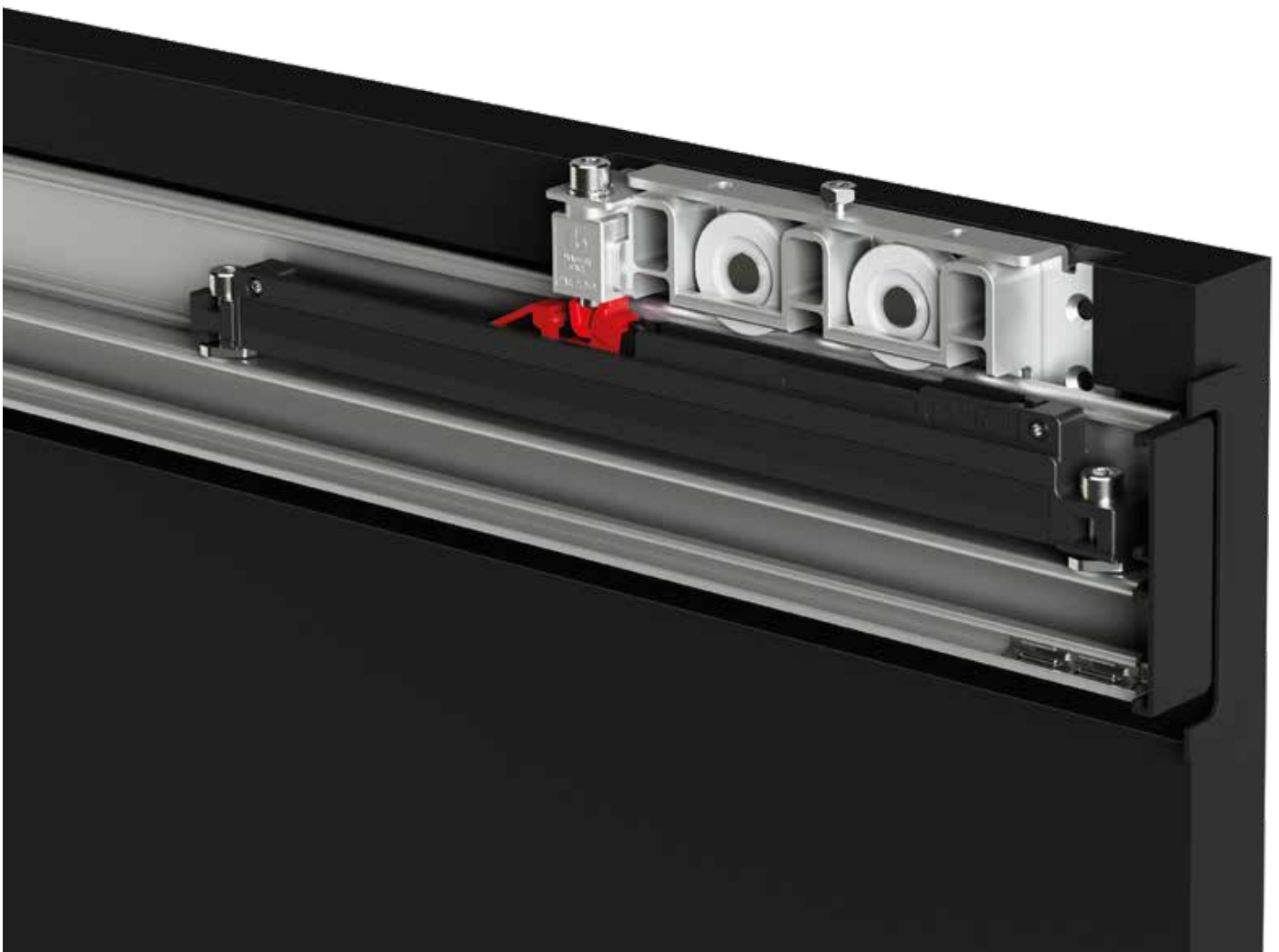

# DIVA FLUID

PATENTED

**Diva Fluid** is the **new patented sliding system dedicated to design doors**, shaped by exposed aluminium tracks and **Fluid next generation soft-closing technology**.

**Diva Fluid** is featured by minimal style thanks to optimized sliding trolleys built-in the door with a totally updated milling pattern, meanwhile **Patented Fluid dampers are totally concealed into the tracks** in order to stand out the original design of the door. The exposed aluminium sliding tracks are available in various modern finishing solutions according to latest architectural and aesthetical trends.

**Diva Fluid** è l'**innovativo sistema scorrevole brevettato con fermi ammortizzati Fluid di ultima generazione**, dedicato a porte di design.

Caratterizzato da uno stile minimalista, il nuovo sistema **Diva Fluid** con scorrimento frontale esalta il design originale della porta con i nuovi scorrevoli ottimizzati e nascosti grazie alla nuova lavorazione semplificata, mentre i **fermi brevettati Fluid risultano completamente nascosti nei binari** in modo da azzerarne l'impatto visivo.

I binari di scorrimento sono disponibili in varie soluzioni di finitura moderne, coerentemente con le ultime tendenze estetiche e di architettura.

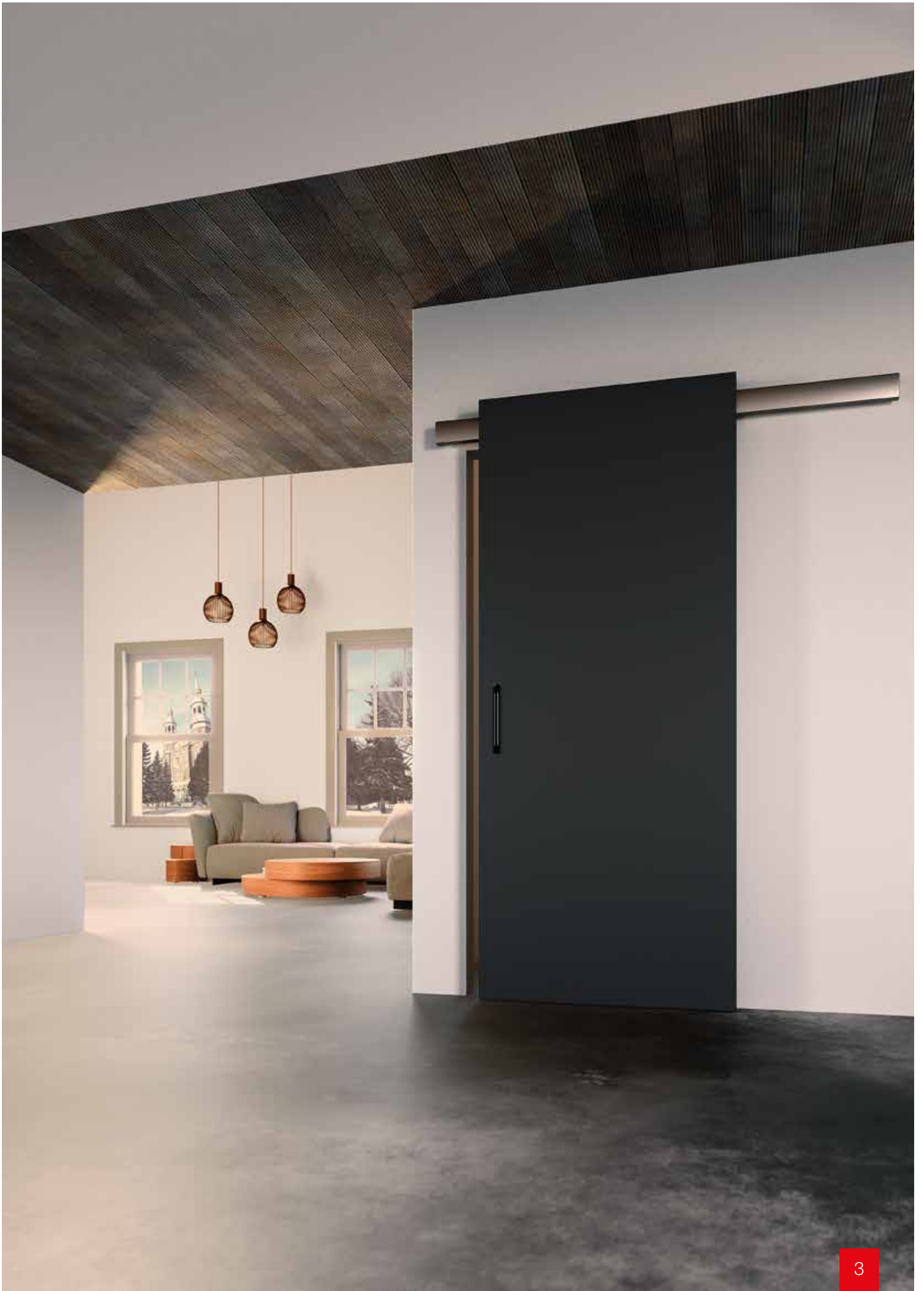

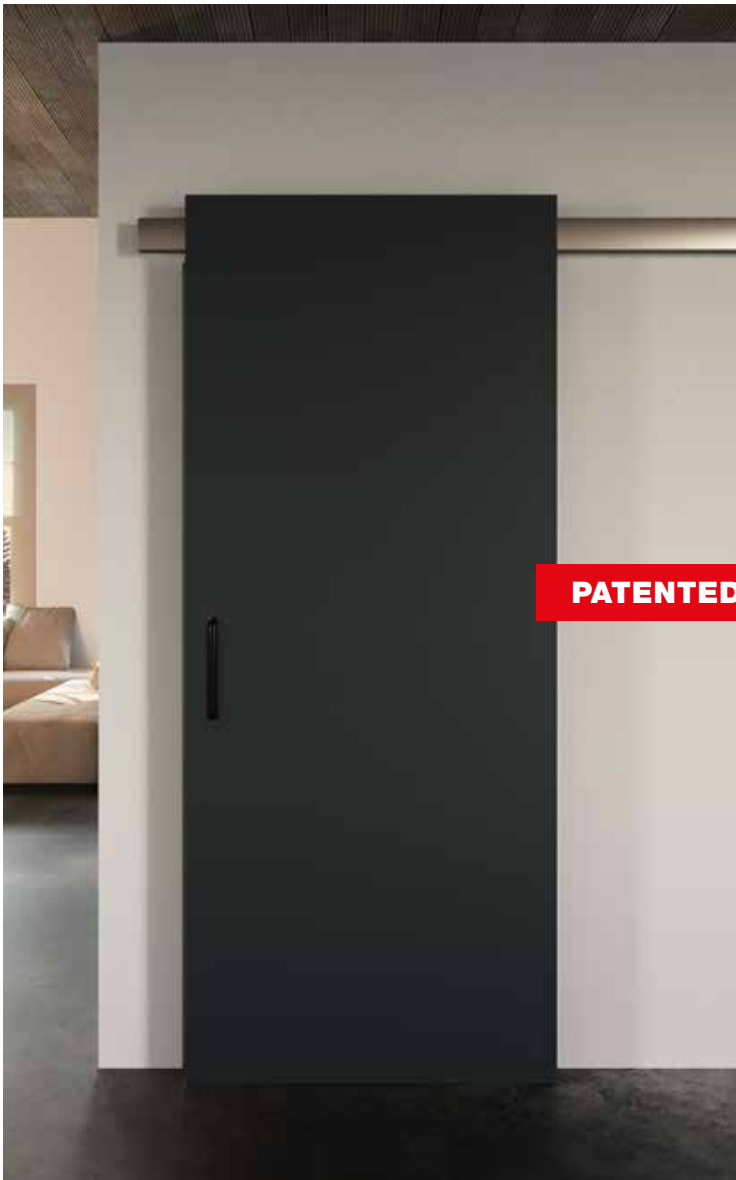

## Easy mounting

New Diva Fluid **assembling process has been simplified** thanks to new support jig, developed to guide installers step by step and to **grant the best functionality possible** of the system.

**PATENTED**

## Facile da montare

Il **processo di assemblaggio** del nuovo Diva Fluid è **stato semplificato** grazie alla nuova maschera (dima) di supporto, sviluppata in modo da guidare gli installatori passo dopo passo e per **garantire la miglior funzionalità possibile** del sistema.



## Safety first

The new patented anti-jumping system allows to grant the maximal safety to all installers and end-users, avoiding the door to fall in any circumstance.

## La sicurezza prima di tutto







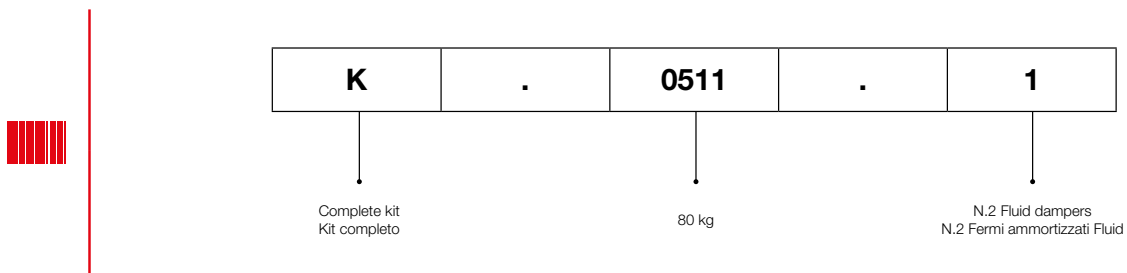

Il nuovo anti-sganciamento brevettato permette di garantire la massima sicurezza per tutti gli installatori e gli utenti finali, impedendo alla porta di cadere in qualsiasi circostanza.



<b>Diva Fluid</b>		COMPLETE BOX KIT / KIT COMPLETO IN SCATOLA		
<b>K</b>	Complete kit / Kit completo			
	.	0511		
			.	
			1	N.2 Fluid dampers N.2 Fermi ammortizzati Fluid

EXAMPLE / ESEMPIO



Tracks / Binari		ALUMINUM FINISHES CODES / CODICI FINITURE ALLUMINIO		
CODE / CODICE	DRILLED CODE / CODICE FORATO	FINISH COLOR / COLORE FINITURA		
8 01 0.0 .....	8 01 2.0 .....		<b>01 A</b>	Anodized Silver / Argento
8 02 0.0 .....	8 02 2.0 .....		<b>02 AS</b>	Brushed Anodized Silver / Argento Spazzolato
8 12 0.0 .....	8 12 2.0 .....		<b>12 E3</b>	Anodized Dark Brown / E3
8 13 0.0 .....	8 13 2.0 .....		<b>13 E3S</b>	Brushed Anodized Dark Brown / E3 Spazzolato
8 14 0.0 .....	8 14 2.0 .....		<b>14 N</b>	Anodized Black / Nero
8 15 0.0 .....	8 15 2.0 .....		<b>15 NS</b>	Brushed Anodized Black / Nero Spazzolato
8 16 0.0 .....	8 16 2.0 .....		<b>16 NK</b>	Anodized Nickel / Nichel
8 17 0.0 .....	8 17 2.0 .....		<b>17 NKS</b>	Brushed Anodized Nickel / Nichel Spazzolato

Tracks / Binari		PLASTIC FINISHES CODES / CODICI FINITURE PLASTICA		
CODE / CODICE	FINISH COLOR / COLORE FINITURA			
8 14 0.0 .....		<b>14 N</b>	Anodized Black / Nero	
8 23 0.0 .....		<b>23 GR</b>	Gray / Grigio	

# Diva Fluid

Patented sliding system with Fluid soft-closing technology  
Sistema di scorrevoli brevettato con fermi ammortizzati Fluid

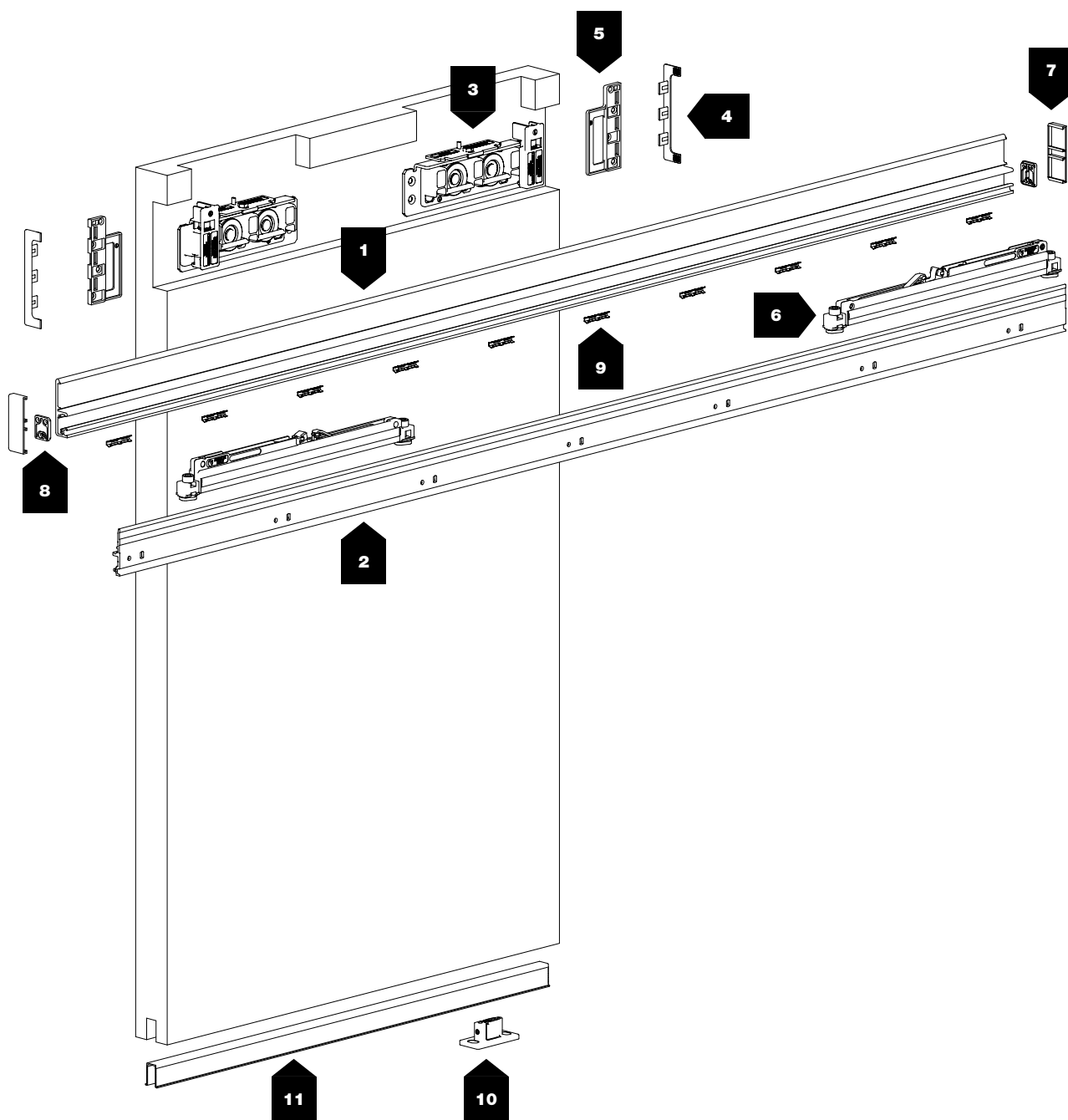



80 kg  
176 lbs



600 ÷ 1500 mm  
23 5/8" ÷ 59"

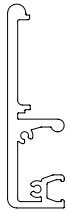
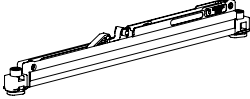

10 mm  
3/8"

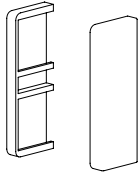
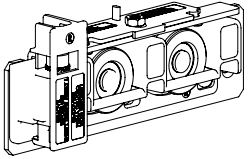
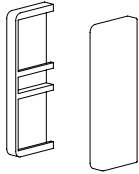
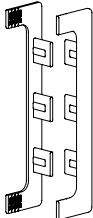
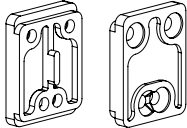
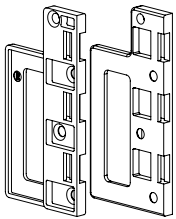
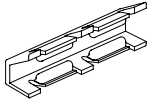
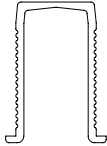
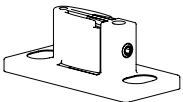
N°	Barcode		kg		N°	Barcode		kg	
1	2560		80		6	2562/80		80	
	8 02 0 .02560								
	8 13 0 .02560								
	8 15 0 .02560								
8 17 0 .02560									
2	2570		80		7	2567/A		-	
	8 01 2 .02570								
	8 12 2 .02570								
	8 14 2 .02570								
8 16 2 .02570									
3	2564_DX		80		7	2567/N		-	
	2564_SX								
4	2563/A		80		8	2565		-	
	2563/N		80						
5	2559		-		9	3491		-	
11	121		-		10	333		-	
	8 14 0 .00121								
	8 23 0 .00121								

# Diva Fluid

Patented sliding system with Fluid soft-closing technology  
 Sistema di scorrevoli brevettato con fermi ammortizzati Fluid



**80 kg**



N.2 Fluid dampers  
 N.2 Fermi ammortizzati Fluid



Patented system  
 Sistema brevettato



Ball bearings  
 Cuscinetti a sfera



**A** Anodized Silver  
 Argento



**N** Anodized Black  
 Nero

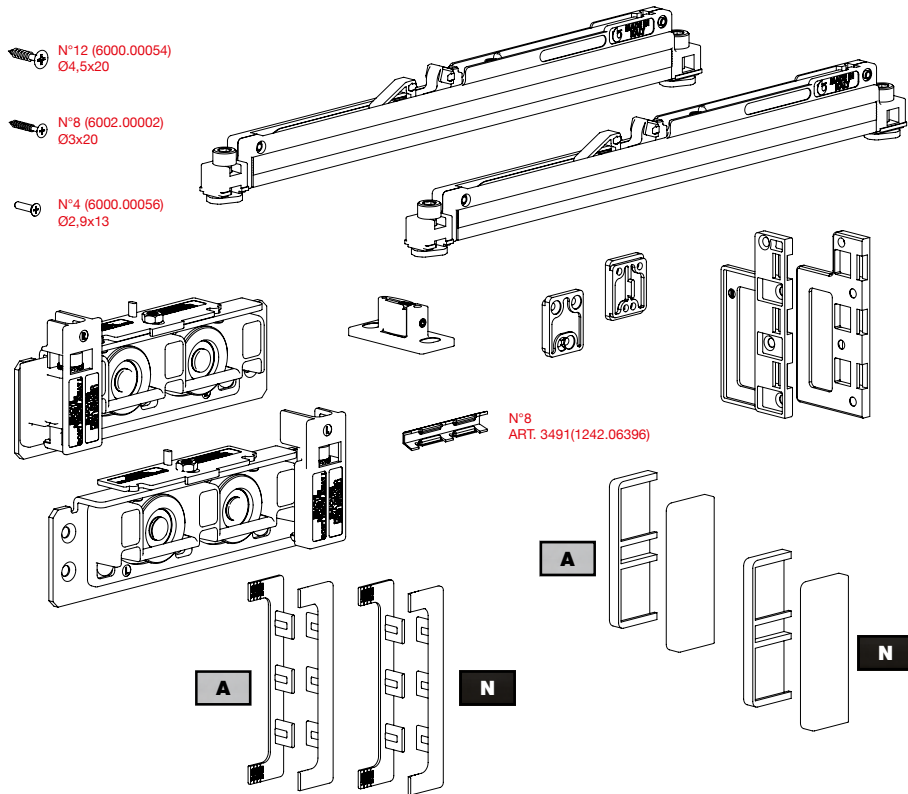

CODE		
K.0511.1		4x



**STANDARD HOLES AND MEASUREMENTS / FORATURE E MISURE STANDARD**

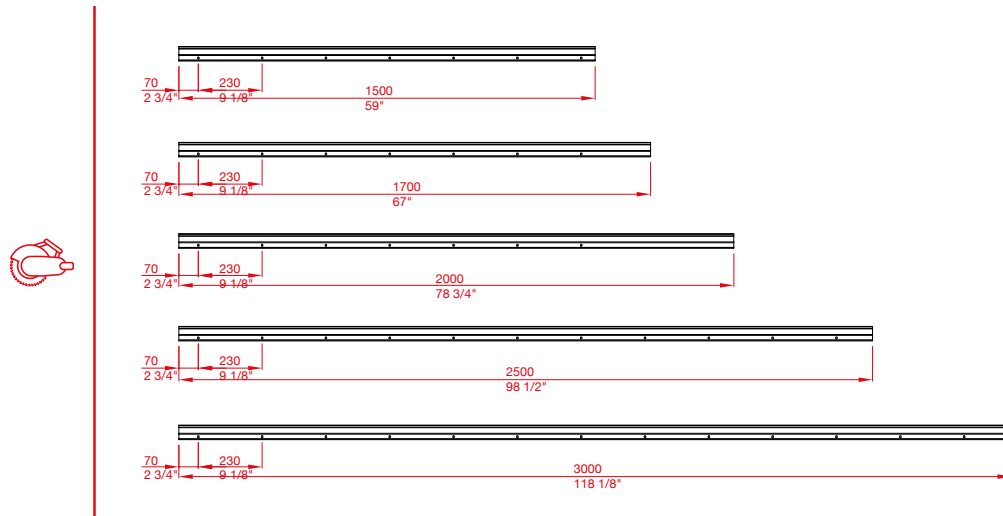

**HOLES AND SIZES ON REQUEST / FORATURE E MISURE A RICHIESTA**

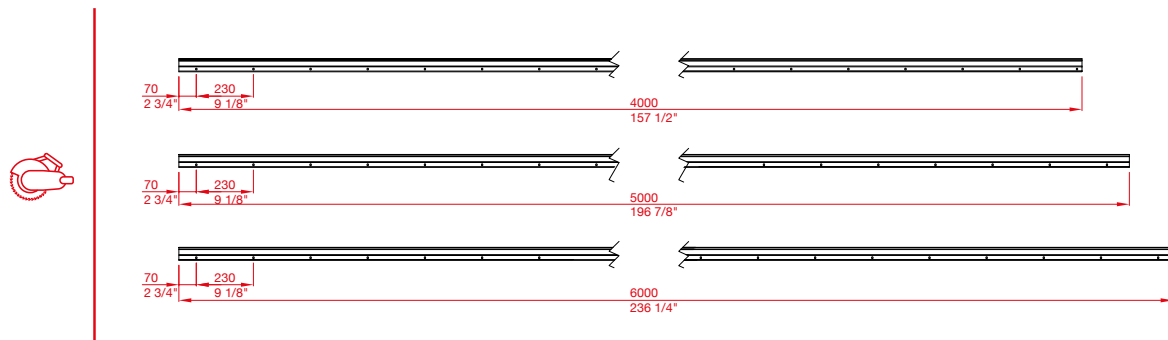

**TRACKS / SPECIFY ARTICLE NUMBER, LENGTH AND COLOR WHEN ORDERING  
 BINARI / AL MOMENTO DELL'ORDINE SPECIFICARE ARTICOLO, LUNGHEZZA E COLORE**

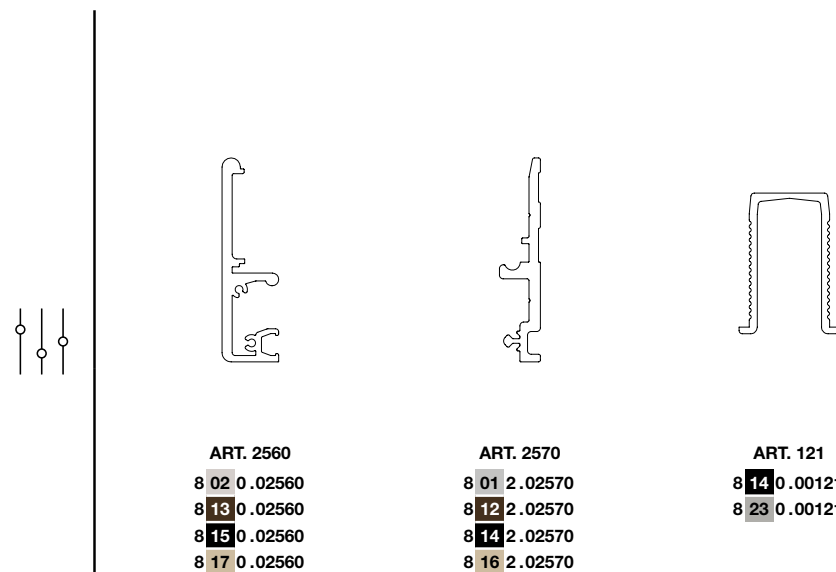

<b>01</b>	Anodized Silver Argento
<b>02</b>	Brushed Anodized Silver Argento Spazzolato
<b>12</b>	Anodized Dark Brown E3
<b>13</b>	Brushed Anodized Dark Brown E3 Spazzolato
<b>14</b>	Anodized Black Nero
<b>15</b>	Brushed Anodized Black Nero Spazzolato
<b>16</b>	Anodized Nickel Nichel
<b>17</b>	Brushed Anodized Nickel Nichel Spazzolato
<b>23</b>	Grey Grigio

**STANDARD MEASUREMENTS DESCRIPTION / DESCRIZIONI MISURE STANDARD**

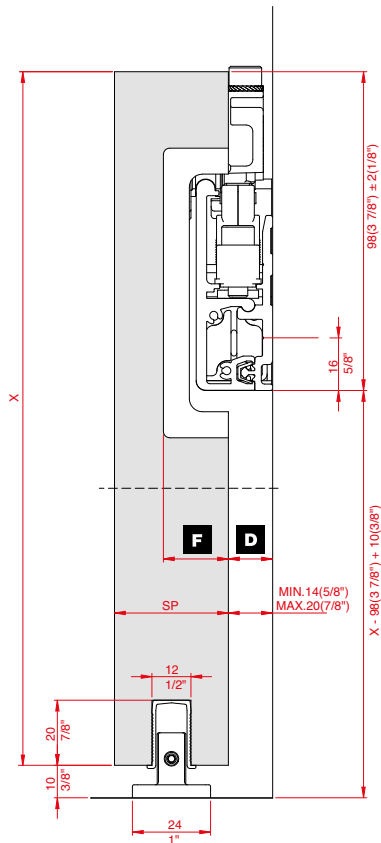
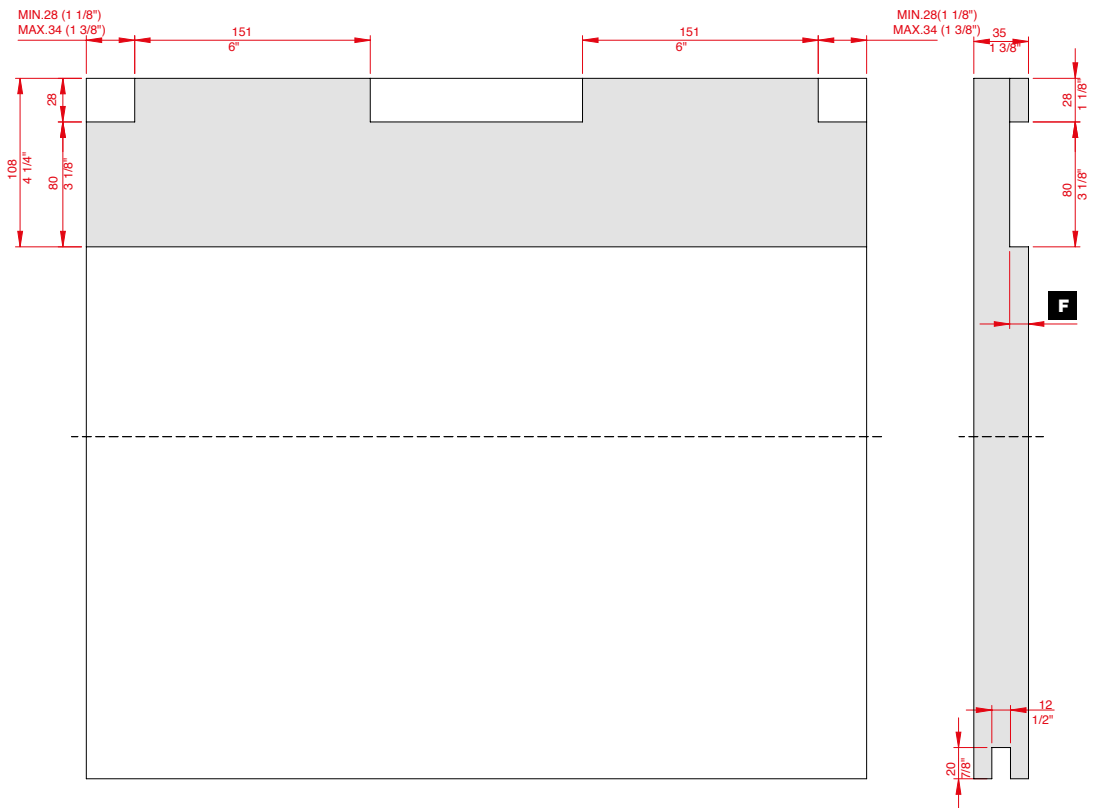

<b>F</b>	<b>D</b>
<b>12 (1/2")</b>	<b>20 (7/8")</b>
<b>14 (5/8")</b>	<b>18 (3/4")</b>
<b>16 (5/8")</b>	<b>16 (5/8")</b>
<b>18 (3/4")</b>	<b>14 (5/8")</b>



## **Milcasa Store**

[www.milcasastore.com](http://www.milcasastore.com)  
[support@milcasastore.com](mailto:support@milcasastore.com)

(888) MILCASA  
(888) 645-2272