

B100 - SINGLE 40"

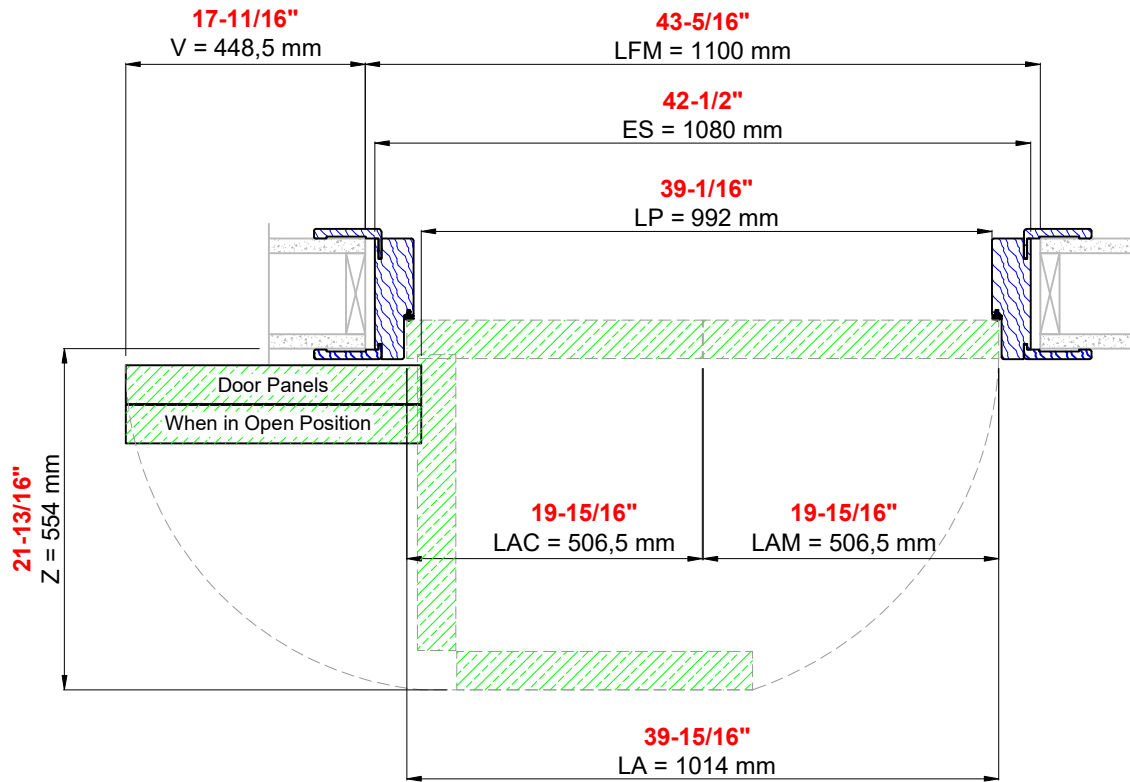

- LFM** = R.O. Width
- ES** = Net Frame
- LP** = Net Clearance Width
- LAC** = Lead Door Panel Width
- LAM** = 2nd Door Panel Width
- LA** = Combined Door Panel Width
- Z** = Panel Projection Radius
- V** = Wall Coverage when open
- HFM** = R.O. Height
- HS** = Jamb Height
- HP** = Net Clearance Height
- HA** = Panel Height

